

THE SEMINAR OF JACQUES LACAN

BOOK X

ANXIETY

1962 - 1963

Translated by Cormac Gallagher from unedited French typescripts

FOR PRIVATE USE ONLY

Seminar 1: Wednesday 14 November 1962

I am going to speak to you this year about anxiety. Someone who is not at all distant from me in our circle, nevertheless let me see the other day his surprise at the fact that I chose this subject which did not seem to him to be something that had all that much to offer. I must say that I will have no trouble in proving the contrary to him. In the mass of questions that are proposed to us on this subject, I will have to make very severe choices. That is why I will try from today to throw you into the work. But already this question seemed to me to preserve the trace of some naivety or other which has never been checked because it seemed to indicate a belief that it is by choice that each year I pick on a subject, like that, which appears interesting to me to continue on some sort of idle chatter. No. As you will see, I think, anxiety is very precisely the meeting point where you will find waiting everything that was involved in my previous discourse and where, together, there await a certain number of terms which may appear not to have been sufficiently connected up for you up to the present. You will see on this terrain of anxiety how, by being more closely knotted together, each one will take its place still better. I am saying still better, because recently it became clear to me, in connection with what was said about phantasy at one of these so-called provincial meetings of our Society, that something concerning this very essential structure called phantasy, had effectively (2) taken its place in your minds. You will see that that of anxiety is not far from it, because it is well and truly the same. I have put on the blackboard for you - even though, after all, a blackboard is not very big - a few little signifiers to guide you or to help your memory: perhaps not all the ones that I would have wanted, but after all it is just as well not to overdo the schemas.

You will see this becoming clearer in a little while. They form two groups, this one and that one - this one which I will complete. On the right, this graph which I apologise for pestering you with for so long, but which it is all the same necessary - because its value as a reference point will I think appear ever more efficacious for you - for me to recall the structure that it ought to evoke to your eyes.

Moreover its choke-pear shape which perhaps has never struck you is not perhaps evoked here by chance; on the other hand, even though last year in connection with the little topological

14.11.62

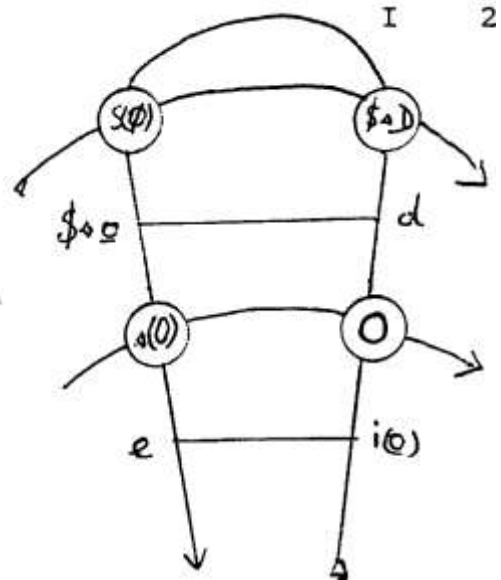
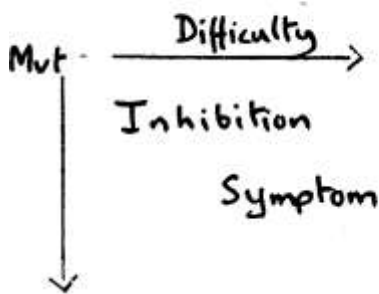
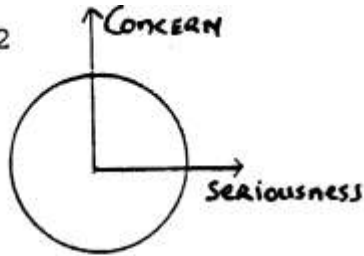

which I made so much of, some people could see being suggested to their minds some forms of the folding back of embryological leaves, even the layers of the cortex, nobody, in connection with the at once bilateral and interlinked arrangement of orientated intercommunication of this graph, nobody has ever evoked in this connection the solar plexus. Of course I am not claiming by that to deliver its secrets to _____-you, but this curious little homology is perhaps not as external as one might think and deserved to be recalled at the beginning of a discourse on anxiety.

Anxiety, I would say, up to a certain point the remark by which I introduced my discourse a little earlier, the one made by one of the people close to me, I mean in our Society, anxiety does not seem to be what stifles you, I mean as psychoanalysts. And nevertheless, it is not too much to say that it ought to in, what I might call, the logic of things, namely of the relationship that you have with your patient. After all to sense what the subject can tolerate, in terms of anxiety, is something that puts you to the test at every instant. It must therefore be supposed that, at least for those among you who are formed in the technique, the thing has ended up by slipping into your way of regulating matters in the most imperceptible way, it must be said. It is not excluded, and thank God for it, that the analyst, provided he is already disposed to it, I mean by very good dispositions to be an analyst, that the analyst at the beginning of his practice should experience some anxiety from his first relations with the patient on the couch.

Again it would be well to touch in this connection on the question of the communication of anxiety. Is this anxiety that you are able, it appears, to regulate so well in yourselves, to damp down the fact that it guides you, is it the same as that of the patient?

Why not? It is a question that I am leaving open for the moment, (4) perhaps not for very long, but which it is worthwhile opening up from the beginning, even if it is necessary to have recourse to our essential articulations in order to give it a valid response, therefore to wait for a moment at least, in the distances, in the detours that I am going to propose to you and which are not absolutely beyond the capacity of those who are my

listeners to forecast. Because if you remember, already precisely in connection with another series of so-called Journées provinciales which were far from having given me as much satisfaction, in connection with which in a sort of inclusion, parenthesis,- anticipation, in my discourse of last year I thought I should warn you and project ahead a formula indicating the relation between essential anxiety and the desire of the Other. For those who were not there, I recall the fable, the apologue, the amusing image of it which I thought I ought to present before you for a moment: putting on the animal mask which the wizard of the grotto of the three brothers covers himself with, I imagined myself before you confronted with another animal, this one real and supposed to be gigantic on this occasion, that of the praying mantis. And moreover since I did not know what kind of mask I was wearing you can easily imagine that I had some reason not to be reassured, in the case where by chance this mask would not have been unsuitable for drawing my partner into some error about (5) my identity, the thing being well underlined by the fact that I had added that in the enigmatic mirror of the ocular globe of the insect I did not see my own image. This metaphor preserves all its value today and it is what justifies the fact that at the centre of the signifiers that I put on this blackboard, you see the question which I introduced a long time ago as being the hinge between the two levels of the graph in so far as they structure this relationship of the subject to the signifier which as regards subjectivity appears to me to be the key of what introduces into Freudian doctrine the Che vuoi?, "What do you want?". Push a little bit more the functioning, the insertion of the key, and you have "What does he want of me?. Que me veut-il?, with the ambiguity about the me that French permits between the indirect and direct complement: not just only "What does he want from me?, Que veut-il à moi?", but something in suspense which directly concerns the moi which is not like "How does he want me?, Comment me veut-il?", but which is "What does he want with respect to this place of the ego? Que veut-il concernant cette place du moi?", which is something in suspense between the two levels, $\$ o) - d$ and $e - i(o)$, the two points of return which in each one designates the characteristic effect and the distance which is so essential to construct at the source of everything into which we are now going to advance, a distance which renders at once homologous and so distinct the relation between desire and narcissistic identification. It is in the operation of the dialectic which links these two levels so closely that we are going to see there being introduced the function of anxiety, not that it is in itself the mainspring of it, but that it is by the (6) phases of its appearance what allows us to orientate ourselves in it. So therefore when I posed the question of your relations as an analyst to anxiety, a question which precisely leaves in suspense this one: who are you sparing? The other, no doubt, but also just as much yourself and even though these two sparings overlap they should not be allowed to become confused. This is even one of the aims which at the end of this discourse will be proposed to you. For the moment I am introducing this indication of method that what we are going to have to draw in terms of a teaching from this research on anxiety, is to see the privileged point at which it emerges. It is to be modelled on an

orography of anxiety which leads us directly to a relief which is that of the term-to-term relationships which is constituted by this more than condensed structural attempt which I thought I should make the guide of our discourse for you.

If you know then how to come to terms with anxiety, it will already make us advance to try to see how, and moreover, I myself would not be able to introduce it without coming to terms with it in some way or other - and that is the danger perhaps: I must not come to terms with it too quickly: this does not mean either that in any way whatsoever, by some psychodramatic game or other, my goal ought to be to throw you (vous jeter) into anxiety with the play on words that I already made about this je of the jeter. Everyone knows that this projection of the I into an introduction to anxiety is for some time the ambition of a philosophy described as existentialist to give it its name. There are no (7) lack of references since the time of Kierkegaard, Gabriel Marcel, Chestov, Berdiaef and some others; not all of them have the same place nor are they all as usable. But at the beginning of this discourse, I would like to say that it seems to me that this philosophy in so far as, from its patron, the first named, to those whose names I advanced later, it is undoubtedly marked by a certain degradation. It seems to me that I see this philosophy marked, I would say, by some sort of haste unrecognised by itself, marked, I would say, by a certain disarray with respect to a reference which is the one to which at the same epoch the movement of thought was very close to, the reference to history. It is from a disarray (désarroi), in the etymological sense of this term, with respect to this reference that there is born and is precipitated existentialist reflection.

The horse of thought, I would say, to borrow from little Hans the object of his phobia, the horse of thought which imagines itself for a time to be the one pulling the coach of history, bucks all of a sudden, goes mad, collapses and gives itself over to this great Krawall machen to refer ourselves again to little Hans who gives one of these images to his favourite fear. This, is indeed what I am calling here the movement of haste in the bad sense of the term, that of disarray. And it is for that reason that it is far from being what interests us most in the line of descendance, the line of descendance of thought that we have pin-pointed just now, like everyone else moreover, by the term existentialism.

(8) Moreover one could remark that the latest comer, and not one of the least great, Monsieur Sartre, exerts himself quite explicitly not simply to get this horse back on his feet, but -co put him again between the shafts of history. It is precisely in function of this that Monsieur Sartre has busied himself a good deal, has questioned himself a good deal, about the function of seriousness (du sérieux). There is also someone whom I did not put in the series and therefore, because I am simply approaching, and touching at the start on what is in the background of the picture, the philosophers who take note of the point that we have got to: "Will the analysts be able to measure up to what we say about anxiety?", there is Heidegger. It is quite certain that with the use that I made above of the pun on the word jeter, it

was indeed to him, to his original dereliction that I was closest.

The being for death, to call it by its name, which is the access path by which Heidegger, in his broken-off discourse, leads us to his present, enigmatic interrogation on the being of the existent, I believe, does not really pass by way of anxiety. He has named the living reference of the Heideggerian question: it is fundamental, it is about everything, it is about the one, it is about the omnitude of the human everyday: it is concern (le souci). Of course, from this point of view it could not be foreign to us, any more than concern itself. And since I have called here two witnesses Sartre and Heidegger, I will not deprive myself from calling on a third, in so far as I do not believe him unworthy to represent those who are here in the (9) process also of observing what he is going to say, and it is myself. . I mean that after all from the testimonies that I had again in recent hours, of what I would call the expectation - it is not just your's that I am speaking about in this case - therefore undoubtedly, I had these testimonies, but that there came to me last evening a work whose text I had asked one of you for, indeed to orientate myself in connection with a question that he himself had posed me, a work which I had told him I was waiting for before beginning my discourse here.

The fact that it was thus brought to me in a way on time, even if I have not been able to get to know it in the interval, since after all I also come here on time to respond to your expectation, is this a movement that is likely in itself to give rise to anxiety? Without having questioned the person concerned, I do not believe it with regard to myself. Indeed, I can respond, in the face of this expectation which is nevertheless designed to weigh me down with some sort of weight, that this is not, I believe I can say it from experience, the dimension which in itself gives rise to anxiety. I would even say on the contrary that I wanted to make this last reference, which is so close that it may appear problematic to you, in order to indicate to you how I intend to put you to what is my question from the beginning, at what distance to speak to you about it without putting it immediately into a cupboard, without leaving it in a crazy state either, at what distance is this anxiety to be put?

(10) Well then, faith, at the right distance, I mean the one which does not in any case place us too close to anyone, at precisely this familiar distance which I evoked for you by taking these last references, the one to my interlocutor who brought me my paper at the last minute and the one to myself who must here take a risk in my discourse on anxiety.

We are going to try to tuck this anxiety under our arms. It will not be any more indiscreet for all that. This will really leave us at the opaque distance, believe- me, which separates us from those who are closest to us. So then, between this concern and this seriousness and this expectation, are you going to believe that this is the way that I wanted to circumscribe it, to corner it? Well then, disabuse yourselves. If I traced out in the

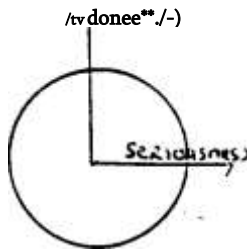

middle of three terms a little circle with its separated arrows, it is to tell you that if it is there that you look for it, you will quickly see that the bird has flown if indeed it was ever there. It is not to be sought in the middle. Inhibitions, symptoms and anxiety, such is the title, the slogan

beneath which for the analyst there appears in his memory, there remains marked the final term of what Freud articulated on this subject.

Today I am not going to go into the text of Inhibitions, symptoms and anxiety because as you have seen from the beginning I have decided today to work without a net, and there is no subject where the net of the Freudian discourse is closer, in short, to giving us a false sense of security; because precisely, when we (11) go into this text, you will see what is to be seen in connection with anxiety, that there is no net, because precisely as regards anxiety, each mesh, as I might appropriately put it, has no meaning except precisely by leaving the void in which anxiety is.

In the discourse, thank God, of Inhibitions, symptoms and anxiety, everything is spoken about except anxiety. Does that mean that one cannot speak about it? Working without a net evokes a tight rope walker. I am taking as a rope only the title Inhibitions, symptoms and anxiety. It leaps, as I might say, to understanding that these three terms are not at the same level. They look irregular and that is why I have written them in this way on three lines and staggered.

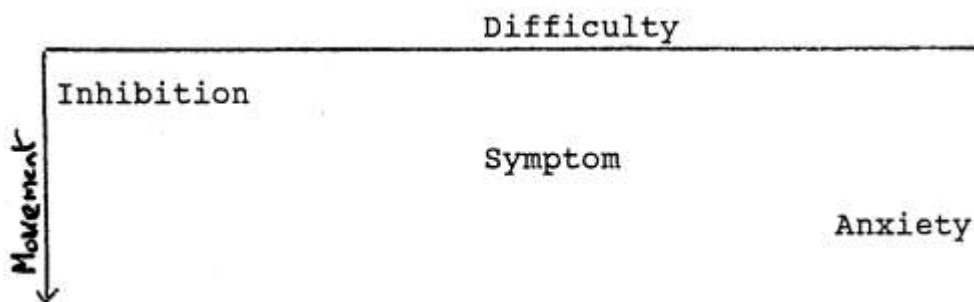

In order for it to work, for one to be able to understand them as a series, it is really necessary to see them as I have put them there, on a diagonal, which implies that the empty squares have to be filled in. I am not going to delay in proving to you something which is immediately obvious, the difference between the structure of these three terms which each, if we wish to situate them, have absolutely not the same terms as context, as entourage. Inhibition, is something which is, in the broadest sense of this term, in the dimension of movement and, what is more, Freud speaks about locomotion when he introduces it.

I am not going to go into the text. All the same you remember enough about it, to see that he cannot do otherwise than speak about locomotion when he introduces this term. In a broader (12) sense, this movement to which I refer, movement exists in every function, even if it is not locomotory. It exists at least metaphorically, and in inhibition, it is the stopping of movement

that is involved.

Stopping: does that mean that this is all inhibition is designed to suggest to us. You will easily object, braking too, and why not, I grant it to you. I do not see why we should not put into a matrix which ought to allow us to distinguish the dimensions involved in a notion so familiar to us, why we should not put on one line the notion of difficulty, and, on another coordinate axis, the one that I have called that of movement. This is even what is going to allow us to see more clearly, because it is also what is going to allow us to come down to earth, to the earth of what is not veiled by the learned word, by the notion, indeed the concept with which one can always come to terms with.

Why should one not use the word "to impede, empêcher", that is after all what is involved. Our subjects are inhibited when they speak to us about their inhibition and when we speak about it at scientific congresses; and every day, they are impeded. To be impeded, is a symptom; and inhibited, is a symptom that has been put in the museum; if one looks at what that means, to be impeded - be very clear about it - does not imply any superstition from the etymological point of view - I make use of it when it is of use to me - impedicare all the same means to be caught in a trap. And that is an extremely precious notion, (13) because it implies the relationship of a dimension to something different which comes to interfere with it and which entangles (empêtre) what interests us, which brings us closer -co what we are trying to know: not at all the function, the term of reference of difficult movement, but the subject, namely what happens under the form, under the name of anxiety.

If I put impediment (empêchement) here, as you see: I am in the symptom column; and right away I point out to you what we will of course be led to articulate about it much further on, namely that the trap is narcissistic capture. I think that you are no longer altogether at a rudimentary level about narcissistic capture, I mean that you remember what I articulated about it at the final term, namely the very precise limit that it introduces as regards what can be invested in the object, and that the residue, the broken fragment, what does not manage to invest itself, is going to be properly what gives its support, its material, to the signifying articulation that is going to be called on the other plane - the symbolic one - castration. The impediment which has come about is linked to this circle which means that in the same movement by which the subject advances towards jouissance, namely towards what is farthest from him, he encounters this intimate break very close at hand, and why? Because of allowing himself to be captured en route by his own image, by the specular image. That is the trap.

But let us try to go further, because we are still here at the (14) level of the symptom. As regards the subject, what term should be brought forward here in the third column? If we push further the questioning about the meaning of the word inhibition (inhibition, impediment), the third term which I propose to you, still in the sense of bringing you back to the ground of lived

experience, to the derisory seriousness of the question, I propose to you the beautiful term of embarrassment (embarras).

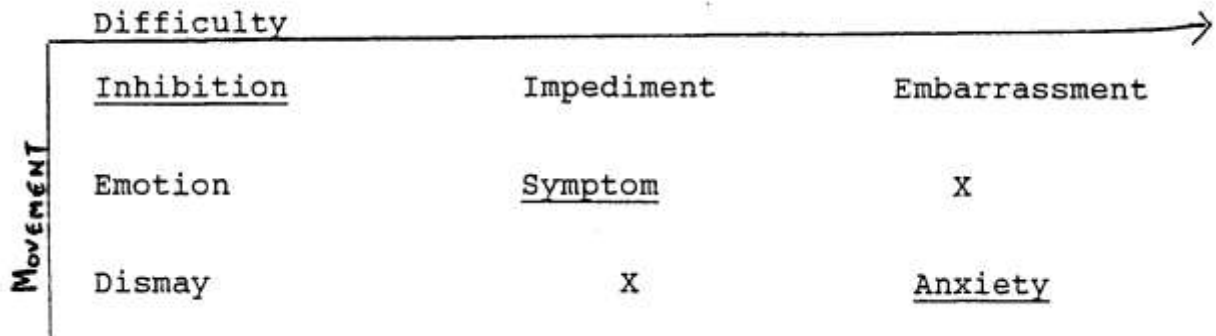

It will be all the more precious for us because today the etymology satisfies me to the full; obviously I have the wind to my back, if you see that embarras is very exactly the subject S invested with the bar, that the etymology imbarrare (imbarricare?) makes properly speaking the most direct allusion to the bar (bara) as such and that moreover this is the image of what is called the most direct lived experience of embarrassment. When you no longer know what to do with yourself, when you do not find anything behind which to barricade yourself, what is indeed involved is the experience of the bar; and moreover this bar can take on more than one form. The curious references that one finds, if what I have been told is correct, in numerous dialects where the embarrassed person, the embarazada - there are no Spaniards here, it does not matter because I have been told that the embarazada, without having recourse to dialect, means a pregnant woman in Spanish. Which is another quite significant form of the bar in its place.

So there we are for the dimension of difficulty. It culminates at this sort of slight form of anxiety which is called embarrassment. In the other dimension, that of movement, what are the terms that we are going to see sketched out? Descending (15) towards the symptom it is emotion. Emotion - you will forgive me for continuing to trust in an etymology which has been so favourable to me up to now - emotion from an etymological point of view refers to movement, except that we will give it a little push by putting into it the Goldsteinian meaning of throwing out, ex, of the line of movement, the movement which disintegrates, the reaction which is described as catastrophic. It is useful for me to indicate to you the place where it should be put, because after all, there have been people who have told us that the catastrophic reaction was anxiety. I believe of course that it is not unrelated. What is not related to anxiety? It is a matter precisely of knowing when it really is anxiety. The fact for example that the same reference has been made - and that without any scruple - to the catastrophic reaction to designate the hysterical crisis as such, or again anger in other cases, sufficiently proves all the same that it could not be enough to distinguish, to pinpoint, to highlight where anxiety is. Let us take the next step: we always remain at the same respectful distance from two great traits of anxiety, but is

there in the dimension of movement something which responds more precisely to the stage of anxiety? I am going to call it by its name which I- have held in reserve for a long time, in your interest, as a delicacy. Perhaps I have made a fleeting allusion to it, but only particularly sharp ears were able to pick it up: it is the word émoi (dismay). Here etymology favours me in a literally, [^]fabulous way. It delights me. That is why I will not hesitate, when I have told you first everything that it brings me, to further abuse it. In any case, let's go.

Linguistic sensibility, as it is put by Messrs Bloch and Von Wartburg to whose article I am expressly asking you to refer - I apologise if it duplicates what I am going to tell you now, duplicates it all the more because what I am going to tell you is a literal quotation from it, I take things where I find them, and I hope nobody minds - Messrs Bloch and Von Wartburg say then that linguistic sensibility has linked this term to the correct word, to the word émouvoir (to move, to affect). But disabuse yourselves, this is not the case. Émoi has nothing to do with emotion for someone who knows how to use it. In any case, realise - I will go quickly - that the term esmayer, that before it esmais and even properly speaking esmoi - esmais, if you are interested is already attested to in the thirteenth century - only knew, to put it in the authors' words, only triumphed in the sixteenth. That esmayer means troubler (to disturb, to frighten) and also se troubler (to show disturbance). That esmayer is effectively still used in dialects and leads us to the popular Latin exmagare which means to make lose one's power, one's energy, and that this, this popular Latin, is linked to a grafting of a western German root which reconstituted gives us magan and which one moreover has no need to reconstitute because in high German and in Gothic, it exists in this same form, ^and that, provided you are German speakers, you can refer to mogen to the English may - mogen in German. In Italian smagare exists I hope? Not really. It comes from Bloch and Von Wartburg - and means, according to them, to become discouraged. A doubt exists therefore. Since there are no Portugese here, I would have no objection to accepting, not what I am putting forward, but Bloch and Von Wartburg, to bringing into play esmaqar which means to crush, which until I learn otherwise I will hold onto as having for what follows a considerable interest. I will pass over Provencal.

In any case, it is certain that the translation which has been accepted, of Triebregung by émoi pulsionnel (instinctual impulse) is quite incorrect and precisely because of the whole distance that there is between emotion and émoi. Émoi is perturbation, collapse of power, Regung is stimulation, the call to disorder, even to a riot. I will fortify myself also with this etymological quest to tell you that up to a certain time, more or less the same as the one that is called in Bloch and Von Wartburg the triumph of émoi, émeute (riot) - precisely had the meaning of emotion and only took on the sense of popular movement more or less from the seventeenth century on.

All of this to make you properly sense that here the nuances,

indeed the linguistic versions evoked, are designed to guide us through something, namely, that if we wish to define by dismay a third place in the sense of what is meant by inhibition if we try to connect it with anxiety, dismay, perturbation, being disturbed as such, indicates to us the other reference which though it (18) corresponds, let us say, to a level equal to that of embarrassment, does not concern the same aspect. Dismay is the most profound form of being disturbed in the dimension of movement. Embarrassment is the high point reached by difficulty. Does this mean that for all that we have rejoined anxiety? The boxes of this little table are there to show you that precisely we are not claiming that. We have filled in here emotion, dismay, these two boxes here, impediment, embarrassment, these ones here. It remains that this one here and that one are empty. How can they be filled? It is a subject which greatly interests us and I am going to leave it for you for a while as a riddle. What is to be put in these two boxes? This is of the greatest interest as regards what is involved in the handling of anxiety. Having posed this little preamble from the reference to the Freudian triad of inhibition, symptom and anxiety, the ground has been cleared to speak about it, I would say, doctrinally. Having been brought back by these evocations to the level of experience itself, let us try to situate it in a conceptual framework. What is anxiety? We have ruled out its being an emotion. And to introduce it, I would say: it is an affect.

Those who follow the movements of affinity or of aversion of my discourse by frequently letting themselves be taken in by appearances, think no doubt that I am less interested in affects than in anything else. This is quite absurd. On occasion, I have tried to say what affect is not: it is not Being given in (19) its immediacy, nor is it the subject in some sort of raw form. It is not, to say the word, protopathic in any case. My occasional remarks on affect mean nothing other than this. And that is precisely why it has a close structural relationship with what is, even traditionally, a subject; and I hope to articulate it for you in an indelible fashion the next time. What on the contrary I did say about affect, is that it is not repressed; and that is something that Freud says just like me. It is unmoored, it goes with the drift. One finds it displaced, mad, inverted, metabolised, but it is not repressed. What is repressed are the signifiers which moor it. This relationship between affect and signifier would require a whole year on the theory of affects. I already allowed there to appear on one occasion the way in which I understood it. I said it to you in connection with anger. Anger, I told you, is what happens in subjects when the little pegs no longer go into the little holes. What does that mean? As regards the level of the Other, of the signifier, it always concerns faith and trust, someone is not playing the game. This is what gives rise to anger. And moreover to leave you today on something which preoccupies you, I am going to make a simple remark. Where best does Aristotle deal with the passions? I think that all the same there are a certain number of you who know already: it is in Book Two of his Rhetoric. The best thing (20) about the passions is caught up in the reference, in the net, in the network of the Rhetoric. It is not by chance. This

is the net. This indeed is why I spoke to you about the net in connection with the first linguistic references that I tried to give you. I- did not take the dogmatic path of giving a general theory of affects before what I had to say to you about anxiety. Why? Because here we are not psychologists, we are psychoanalysts. I am not developing for you a direct logical psychosis, a discourse about this unreal reality which is called the psyche but a praxis which merits a name: erotology. Desire is what is involved, and the affect by which we are urged perhaps to make emerge everything that it involves as a universal, not general, consequence on the theory of affects, is anxiety. It is on the cutting edge of anxiety that we have to maintain ourselves and it is on this cutting edge that I hope to lead you further the next time.

Seminar 2: Wednesday 21 November 1962

Blackboard

	0	S			
0					
	0	ϕ	ϕ	d(ϕ) : d(0) < ϕ	1
	0	ϕ	ϕ	d(ϕ) < i(ϕ) : d(ϕ)	2
				d(x) : d(0) < x	3
				d(θ) < d(0)	} 4
				d(ϕ) : 0 > d(0)	

← The dividing bar

ϕ ϕ 0

θ = zero

As I continue today to get into my discourse on anxiety a little more, I can legitimately pose before you the question of what a teaching is here.

The notion that we may have of it ought all the same to undergo some effect - if here we are in principle, let us say, analysts for the most part, if the analytic experience is supposed to be my essential reference when I address the audience composed of yourselves - from the fact that we cannot forget that the analyst is, as I might say, an interpreter (un interprétant). He plays on this so essential moment which I already accentuated for you on many occasions starting from several subjects of "he did not know", "I did not know" and to which we will leave therefore an indeterminate subject by collecting them into a "one did not know, on ne savait pas".

As regards this "one did not know", the analyst is supposed to know something. Why not even admit that he knows a good deal? The question is not to know - it would be at least premature - whether he can teach it - we can say that up to a certain point, the simple existence of a place like this and of the role that I play in it for some time now, is a way of settling the question well or badly, but of settling it - but to know "what is it to teach it?, qu'est-ce que Renseigner?" .

What does teaching it mean when it involves precisely what it is a matter of teaching, to teach it not simply to the one who does not know, but - it must be admitted that up to a certain point we (2) are all in the same boat here - to. the one who, given what is involved, to one who cannot know.

Observe carefully where, as I might say, the false door leads. An analytic teaching, if there were not this false door, this seminar itself could conceive itself as being in the line, in the prolongation of what happens for example in a supervision where it is what you know, what you are supposed to know, that is brought along, and where I would only intervene to give what is analogous to interpretation, namely this addition by means of which something appears which gives meaning to what you think you know, which makes appear in a flash what it is possible to grasp beyond the limits of knowledge.

It is all the same in the measure that a knowledge exists in this work of development of analysis that we describe as communal rather than collective among those who have experience of it, the analysts, that this knowledge is constituted, that a work of putting it together is conceivable, which justifies the place taken by a teaching like the one which is carried out here. It is because, if you wish, there has already been secreted by analytic experience a whole literature which is called analytic theory that I am forced - often quite against my will - to give it here so much space, and it is what necessitates me doing something which has to go beyond this piecing together, and precisely in the sense of our getting closer, through this piecing together of analytic theory, to what constitutes its source, namely experience.

Here an ambiguity appears which depends not simply on the fact that here some non-analysts are mixed in with us. There is no great inconvenience in this because moreover even the analysts come here with positions, postures, expectations which are not necessarily analytic, and already very sufficiently conditioned by the fact that in the theory that is constructed in analysis there are introduced references of every kind, and much more so than may appear at first sight, that one can qualify as extra-analytic, as psychologising for example. By the simple fact then (3) that I have to deal with this material, the material of my audience, the material of my teaching object, I will be led to refer to this common experience which is the one thanks to which there is established all communication in teaching, namely not to be able to remain in the pure position that I called earlier interpreting, but to pass to a broader communicating position, namely to engage myself on the terrain of "making things Vinderstood, faire comprendre", to appeal in you to an experience which goes well beyond that of strict analytic experience.

This is important to recall because "making things understood" is at the same time that which, in psychology in the broadest sense, is really the stumbling block. Not so much because the accent ought to be put on what at one time for example appeared to be the great originality of a work like that of Blondel on La

conscience morbide, namely that there are limits to understanding: let us not imagine for example, that we understand, as they say, the real authentic lived experience of the sick. But it is not the question of this limit which is important for us; and at a time when I am speaking to you about anxiety, it is important to point out to you that it is one of the questions that we suspend, because the question is much rather to explain why, by what right we can speak about anxiety, when we subsume under this rubric the anxiety into which we can introduce ourselves following one or other meditation guided by Kierkegaard, the anxiety which can lay hold of us at one or other para-normal or even frankly pathological moment, as being ourselves subjects of an experience that is more or less situatable from a psychopathological point of view, the anxiety which is the one we deal with in our neurotics, the ordinary material of our experience, and for that matter the anxiety that we can describe and localise at the source of an experience that is more peripheral for us, that of the pervert for example, even that of the psychotic.

If this homology is justified by a kinship of structure, it can (4) only be so at the expense of the original understanding which nevertheless is going necessarily to increase with the danger of making us forget that this understanding is not that of a lived experience but of a mainspring, and of presuming too much about what we can assume about the experiences to which it refers, specifically those of the pervert or of the psychotic. In this perspective it is preferable to warn someone that he should not believe too much in what he can understand. It is here indeed that the signifying elements take on their importance, denuded as I try to make them by their notation of understandable content and whose structural relationship is the means by which I try to maintain the level necessary for understanding not to be deceptive, while at the same time allowing there to be located the diverse significant terms into which we make our way, and this especially when what is involved is an affect. Because I have not refused this element of classification: anxiety is an affect. We see that the style of approach of such a theme: "anxiety is an affect" is proposed to us from the point of view of the teacher, in accordance with the different paths that one can, I believe, rather summarily, - namely by effectively summing them up - define under three headings, those of the catalogue, namely as regards affect to work out not simply what it means, but what was meant in constituting such a category, a term which undoubtedly puts us in a position of teaching something about the subject of teaching in its broadest sense, and necessarily here to harmonise what is taught within analysis with what is contributed from outside in the widest sense as category, and why not? Very considerable contributions have come to us from there and, you will see, to take a median reference which will come into the field of our attention, there is as regards what occupies us this year - if it is true that, as I said, I am far from refusing to insert this central object of anxiety into the catalogue of affects, into the different theories which have been produced about affect - well then, to take things, I told you, at <5) a kind of median point of the cut, at the level of Saint

Thomas Aquinas to call him by his name, there are some very good things concerning a division which he did not invent concerning affect between" the concupiscent and the irascible, and the long discussion with which he weighs up, in accordance with the formula of scholastic debate, proposition, objection, response, namely which of the two categories is primary with respect to the other, and how he settles it and why. Despite certain appearances, certain references, the irascible is inserted somewhere in the chain of the concupiscent which is already there, which concupiscent therefore is primary with respect to it, this is something which will not fail to be of use to us; because in truth might it not be in the final analysis entirely suspended on a supposition about a Sovereign Good, against which, as you know, we already have substantial objections to make - for us it would be very acceptable; we will see what we can preserve of it, what it clarifies for us. The simple fact is that we can - I would ask you to refer to it - I will give you the references at the appropriate time - we can undoubtedly find here a considerable amount of material to nourish our own reflection. More, paradoxically, than what we can find in recent, modern developments - let us call things by their name: the nineteenth century - of a psychology which claimed to be, without no doubt being fully entitled to do so, more experimental. This again, this path, has the inconvenience of pushing us in the direction, into the category of the classification of affects, and experience proves that too great an abandon in this direction only culminates for us - and even however centrally we may bring it, with respect to our experience, to that part to which a little earlier I gave the trait, the accent of theory - in obvious impasses a lovely testimony of which for example is given by this article which appears in Tome 34, the third part of 1953 of the International Journal, where Mr David Rapaport attempts a psychoanalytic theory of affect.

(6) This article is really exemplary for the properly dismaying evaluation, at which as a matter of fact it culminates, without the author dreaming of hiding it, namely the astonishing result that an author who announces by this title an article which after all could not fail to allow us to hope for something new, original, to come out of it as regards what the analyst can think about affect, should finally culminate only in him also, staying strictly within analytic theory, giving a catalogue of the acceptations in which this term has been used, and seeing that within the very theory itself these acceptations are irreducible to one another, the first being that of affect conceived of as constituting substantially the discharge of the drive, the second within the same theory, and, to go even further, supposedly from the Freudian text itself: affect being nothing but the connotation of a tension at its different phases, usually conflictual, affect constituting the connotation of this tension in so far as it varies, a connotation of the variation of tension, and a third term equally marked as irreducible in Freudian theory itself: affect constituting in a properly topographical reference the signal at the level of the ego concerning 'something happening elsewhere, the danger coming from elsewhere.' The important thing is that he notes that there

still subsists, in the debates of the most recently emerging authors in analytic discussion, divergent claims about the primacy of each one of these three meanings, so that nothing can be resolved about it. And that the author in question can say no more to us about it, is all the same indeed the sign that here the method described as "cataloguing" cannot here be marked indeed by any profound gain, since it culminates in impasses, even indeed in a very special type of infecundity.

There is, differentiating itself from this method - I apologise for going on so long today about a question which is nevertheless of great interest as a preamble, as regard the timeliness of what we are doing here, and it is not for nothing that I am

(7) introducing it, as you will see as regards anxiety - the method that I would call, using a need for consonance with the preceding term, the method of analogy, which will lead us to discern what one can call levels. I saw in a work which I will not otherwise quote today, an attempted gathering together of this kind, where one sees, in separate chapters, anxiety conceived as it is put - it is an English work - biologically, then socially, sociologically, then as far as I know culturally, culturellement, as if it were enough in this way to reveal, at supposedly independent levels, analogical positions, to succeed in doing anything more than separating out, no longer what I called earlier a classification, but here a sort of type.

We know what this method culminates in: in what is called an anthropology. Anthropology, to our eyes, is something which, of **all** the paths to which we might commit ourselves, involves the greatest number of the most hazardous presuppositions. What such **a** method culminates in, no matter how eclectic it is, is always **and** necessarily what we, in our familiar vocabulary, and without making of this name or of this title the index of someone who has **even** occupied such an eminent position, is what we call Jungianism.

On the subject of anxiety, this will necessarily lead us to the theme of this central core which is the absolutely necessary thematic at which such a path culminates. This means that it is very far from what is involved in experience. Experience leads **us** to what I would call here the third way which I would place under the index, under the heading of the function of what I would call that of the key.

The key is what opens, and what functions because it opens. The (8) key **is** the form according to which there should operate or **not** operate the signifying function as such, and what makes it legitimate for me to announce it and to distinguish it and dare **to** introduce **it** as something to which we can trust ourselves, is **net** something which **is** marked here by presumption, for the reason **that** I think that it will be for you, and for those here who **belong to** the teaching profession, a 'sufficiently convincing **ireJIfrence**, **it is** that this dimension is absolutely connatural to **any** teaching, analytic or not, for the reason that there is no **leaching**, I would say - and I would say, for my part, whatever astonishment may result from it among some people as regards what

I teach, and nevertheless I will say it - there is no teaching which does not refer itself to what I would call an ideal of simplicity.

If, earlier, something was enough to give rise for us to an objection in the fact that a cat literally cannot find her kittens as regards what we think, we analysts, by going to the texts on affect, there is something here profoundly unsatisfying, and that it is necessary that, as regards any title whatsoever, we should satisfy ourselves as regards a certain ideal of simple reduction. What does that mean and why? Why, why ever since people have done science - because these reflections are concerned with something quite different and with much vaster fields than that of our experience - has one required the greatest possible simplicity? Why should the real be simple? What could permit us for a single instant to suppose it to be so?

Nothing indeed, nothing other than this subjective initium on which I put the accent here throughout the whole of the first part of my teaching last year, namely that there is no conceivable appearance of a subject as such except from the primary introduction of a signifier, and from the simplest signifier which is called the unary trait.

The unary trait comes before the subject. "In the beginning was the word", means: in the beginning is the unary trait. Everything that is teachable ought to preserve the stigmata of this ultra-simple initium which is the only thing which can justify to our eyes the ideal of simplicity.

(9) Simplicity, singularity of the trait, this is what we bring into the real, whether the real wants it or does not want it. But one thing is certain, it is that it enters, that it has already entered before us because already it is along this path that all the subjects who, for some centuries all the same, have been engaged in a dialogue and have to come to terms as best they can with this condition precisely that there is between them and the real this field of the signifier; it is already by this apparatus of the unary trait that they have constituted themselves as subjects. How could we for our part be astonished at finding its mark in our own field, if our field is that of the subject?

In analysis, there is something which is prior to everything that we can elaborate or understand, and this I will call the presence of the Other. There is no self-analysis; even when one imagines it, the Other is there. I recall it because it is already on this path and on the same path of simplicity that I placed what I had to tell you, what I indicated to you, what I began to indicate to you about something which goes further, namely that anxiety is this certain relationship which I have only imaged up to now. I recalled for you the last time the image, with the sketch I re-evoked of my presence, my very modest and embarrassed presence in the presence of the giant praying mantis, I already told you more therefore in saying to you: this is related to the desire of the Other.

This Other, before knowing what my relationship with its desire means when I am in a state of anxiety, I first of all put the Other there. -To get closer to his desire, I will take, God knows, paths that I have already opened up. I told you: the desire of man is the desire of the Other. I apologise for not being able to go back, for example, to a grammatical analysis that I made during the last Journées Provinciales - that is why I am so keen that this text should come to me intact, so that it can be distributed at a suitable time - the grammatical analysis of what is meant by the desire of the Other and the meaning of this (objective) genitive; but after all those who up to now have (10) been at my seminar may all the same, I think, have enough elements to situate themselves sufficiently.

From the pen of someone, who is precisely the author of this little work to which I alluded at the beginning of this year's teaching the last time, which had been brought to me that very morning o.i a subject which was none other than the one that Lévi-Strauss approaches, that of the suspending of what one could call dialectical reason, at the structuralist level at which Lévi-Strauss places himself, someone making use of it to clarify this debate, to enter into its detours, to disentangle its skein from the analytic point of view, and referring of course to what I said about phantasy as support of desire, does not in my opinion take enough notice of what I am saying when I speak about the desire of man as desire of the Other.

What proves it, is that he believes he can content himself with recalling that this is a Hegelian formula. Now if there is, I **think**, someone who makes no mistake about what The phenomenology of the spirit has brought us, it is myself. If there is nevertheless a point at which it is important to mark that it is tieirfe that I mark the difference and, if you wish, to employ the term, the progress - I would like still better the leap - which is ours with respect to Hegel, it is precisely concerning this function of desire. I am not in a position, given the field that I have to cover this year, to take up again with you step by step the Hegelian text. I am alluding here to an author who, I hope, will see this article published and who shows a quite sensitive knowledge of what Hegel says on this point.

I am not all the same going to follow him onto the plane of the quite original passage which he very well recalled on this occasion. But for the totality of those who are listening to me and with what has already passed, I think, to the common level of this audience concerning the Hegelian reference, I will say immediately, in order to make you sense what is involved, that in Hegel, as regards this dependence of my desire with respect to the desirer who is the Other, I am dealing, in the most certain J11) and most articulated fashion, with the Other as consciousness. The Other is the one who sees me - how that involves **my** desire, you know, you already glimpse sufficiently, but I will come back to it later, for the moment I am making massive oppositions - the Other is the one who sees me and it is on this plane, on this plane that you see that there is launched all by itself, according to the basis with which Hegel

inaugurates The phenomenology of the spirit, the struggle on the plane of what he calls "pure prestige", and my desire is involved in this.

For Lacan, because Lacan is an analyst, the Other is there as unconsciousness constituted as such, and he involves my desire in the measure of what he is lacking and that he does not know. It is at the level of what he is lacking and that he does not know that I am involved in the most pregnant fashion, because for me there is no other detour, to find what I am lacking as object of my desire.

That is why there is for me not alone no access, but no possible sustentation of my desire which is pure reference to an object, whatever it may be, unless by coupling it, by linking it with the following which is expressed by the which is this necessary dependence on the Other as such. This Other is of course the one that throughout these years, I think I have accustomed you to distinguish at every instant from the other, my fellow. It is the Other as locus of the signifier. It is my fellow among others of course, but not simply that, because of the fact that it is also the locus as such at which there is established the order of the singular difference of which I spoke to you at the beginning.

Am I now going to introduce the formulae which I marked for you on the right which I do not pretend - far from it, given what I said to you right at the beginning - are going to surrender their malice to you immediately. I would ask you today, like the last time - that is why this year I am writing these things on the blackboard - to take them down. You will see how they function afterwards. The desire of desire, in the Hegelian sense, is therefore desire of a desire which responds to the appeal of the subject.

(12) It is desire of a desirer. Why does he need this desirer, who is the Other? It is because from whatever angle you place yourself, but in the most articulated fashion in Hegel, he needs him in order that the Other should recognise him, in order to receive recognition from him. What does that mean? That the Other as such is going to establish something, "o", which is precisely what is involved at the level of what desires - this is the, whole impasse - in requiring to be recognised by him. There where I am recognised as object, because this object in its essence is a consciousness, a Selbstbewusstsein, there is no mediation other than that of violence. I obtain what I desire, I **am** object and I cannot tolerate myself as object, I cannot tolerate myself unless I am recognised in my world, the only mode of recognition that I can obtain, must necessarily therefore at any, price be settled between our two consciousnesses. This is **tfre**, f^te.Pf desire in Hegel. The desire of desire in the Lajcknian or analytic sense, is the desire of the Other in a ff^hipn that is much more fundamentally (princiipiellement) open t\$# sort of mediation. At least that is the way it looks at first, japproach. Because desire here - you will see it in the verybformula/ the signifier, that I put here on the blackboard,

2, that I am going rather far in the sense of going against, I mean of contradicting what you may now be expecting - is desire qua supporting-image of this desire, a relationship therefore of $d \cdot (\text{£} > -)$ to what I write, to what I do not hesitate to write: $i(o)$, even and precisely because that creates an ambiguity with the notation that I usually designate of the specular image (here we do not know yet, when, how and why the specular image can be, but it is undoubtedly an image; this is not a specular image, it is of the order of image, it is the phantasy, which I do not hesitate on occasion to overlap with this notation of the specular image). I am saying therefore that this desire is desire in so far as its supporting image is the equivalent - that is why the two points (:) which were here are there - is the equivalent of the desire of the Other. But here the Other is (13) connoted because it is the Other at the point where it is characterised as lack. The two other formulae 3 and 4 (because there are only two, this one and then the second one; you see included in a bracket for the second, two formulae which are only two ways of writing the same thing, in one direction, then in the palindromic direction by returning after being like that, by returning in this way; that is all that is written in the third line).

I do not know then whether I will have the time today to get to the translation of these two final formulae. You should know already however that they are one and the other constructed, the first to highlight that anxiety is what shows the truth of the Hegelian formula, namely that if the Hegelian formula is partial and false and makes a false door of the whole beginning of the Phenomenology of the Spirit as I indicated to you on several occasions already by showing you the perversion which results, and which goes very far and even into the political domain, from this too narrow starting point centred on the imaginary because it is all very well to say that the servitude of the slave is full of consequences and leads to Absolute Knowledge. But it also means that the slave will remain a slave until the end of time.

It is Kierkegaard who gives the truth. It is not Hegel's truth, but the truth of the anxiety which leads us to our remarks about desire in the analytic sense.

Remarks: in the two formulae, that of Hegel and mine, in the first term of the formulae (above,), however paradoxical it may **appear**, it is an object o which desires. Although there are differences, there is something in common between the Hegelian concept of desire and the one that I am promoting. It is at a **moment**, the point of an unacceptable impasse in the process.

{,14) Selbstbewusstsein in Hegel, is an object, namely this something where the subject, being this object, is irremediably marked by finiteness, it is this object which is affected by desire. This is the way in which what I am producing before you **has** something in common with the Hegelian theory, except that at pur analytic level, which does not require the transparency of Selbstbewusstsein - it is a difficulty of course, but not of a

kind to make us retrace our steps, nor for that matter to engage ourselves in a fight to the death with the Other - because of the existence of the unconscious, we can be this object affected by desire.

It is even qua thus marked by finiteness that for us, as subjects of the unconscious, our lack can be desire, finite desire, indefinite in appearance, since the lack, always involving some void, can be filled in several ways at first, even though we know* very well because we are analysts, that we do not fill it in ninety-nine different ways. And we will see why and which ones.

What I would call the classical, moralistic, not so much the theological, dimension of the infinity of desire is in this perspective to be completely reduced. Because this pseudo-infinity depends on only one thing which luckily a certain part of the theory of the signifier, which is none other than that of whole numbers, allows us to image. This false infinity is linked to this sort of metonymy which, as regards the definition of integers, is called recurrence. It is quite simply the law that we have, I believe, powerfully accentuated last year in connection with the repetitive One. But what our experience (15) shows us - I will articulate it for you - is that in the different fields that are proposed to it, specifically and distinctly, the neurotic, the perverse, indeed the psychotic, is that this One to which there is reduced in the final analysis the succession of signifying elements, the fact that they are distinct and that they succeed one another does not exhaust the function of the Other. And this is what I am expressing here starting from this originating Other as locus of the signifier, of this still inexistent S which by situating itself as determined by the signifier, under the form of these two columns which are those under which as you know one can write down the operation of division.

o	S
\$	φ
o	
Other's side	my side

With respect to this Other, depending on this Other, the subject is inscribed as a quotient, he is marked by the unary trait of the signifier in the field of the Other. Well, it is not for all that, as I might say, that he cuts the Other into slices. There is a remainder in the sense of division, a residue. This remainder, this final other, this irrational, this proof and sole guarantee when all is said and done of the otherness of the Other, is the o. And this is why the two terms, f and Q , the subject as marked by the bar of the signifier, the little object o as residue of the putting into condition, if I can express myself in this way, of the Other, are on the same side, both on the objective side of the bar, both on the side of the Other. The phantasy, the support of my desire, is in its totality on the side of the Other, $\$$ and Q . What is on my side now, is precisely what constitutes me as unconscious, namely j , the Other in so far as I do not reach it.

Am I going to lead you any further here? No, because I have run out of time. And in order not to leave you on a point which is so closed off as regards the continuation of the dialectic which is going to be inserted into it and which, as you will see, requires that the next step that I have to explain to you is what I am committing to the affair, namely that in the subsistence of the phantasy I will image the sense of what I have to produce with a reminder of an experience which I think will be for you - God knows in what is most interesting for you, I am not the one who said it, it is Freud -: of some use in the experience of love.

(16) I want to point out to you, at the point that we are at, that in this theory of desire in its relationship to the Other you have the following key: the fact is that, contrary to the hope that the Hegelian perspective may give you, the mode of the conquest of the other, is the one, alas, too often adopted by one of the partners: "I love you, even if you don't want it". You must not believe that Hegel did not glimpse this prolongation of his doctrine. There is a very precious little note where he indicates that he could have made his whole dialectic pass along this path. It is the same note where he says that, if he did not take this path, it is because it seemed to him to lack seriousness. How right he was! Try it out. Let me know how successful it is! There is nevertheless another formula which if **it** does not demonstrate any better its effectiveness, it is perhaps only because it is not articulatable, but that does not mean that it is not articulated. It is "I desire you, even if I do not know it". Wherever it succeeds, however inarticulatable **it** may be, in making itself heard, this one, I assure you is irresistible. And why? I will not leave this as a riddle for you. If this were sayable, what would I be saying by it? I would be saying to the other that, desiring him without knowing **it of** course, still without knowing it, I take him as the object unknown to myself of my desire, namely in our conception of desire that I identify him, that I identify you, you to whom I am speaking, you yourself, to the object which is lacking to yourself, namely that by this circuit that I have to take to **reach** the object of my desire, I accomplish precisely for him what he is looking for. It is indeed in this way that innocently **or** not, if I take this detour, the other as such, object here - you should note - of my love, will fall necessarily into my toils. I will leave you on this, on this recipe, and I will see you the next time.

Seminar 3 : Wednesday 28 November 1962

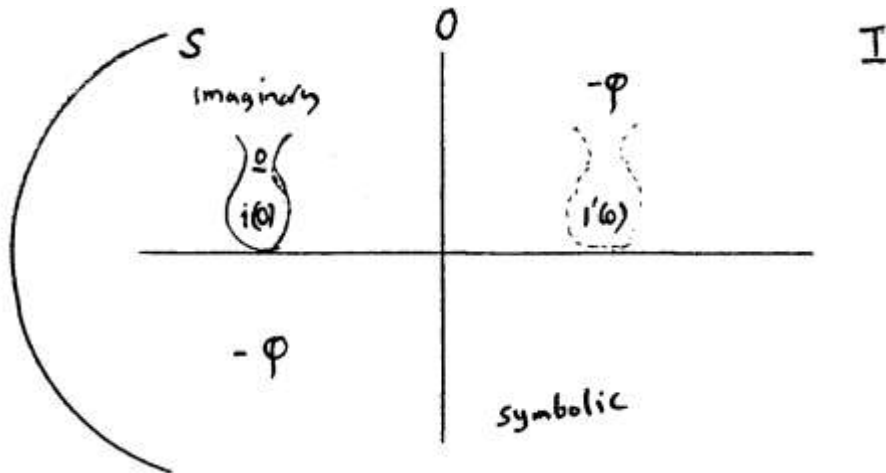

You will have noticed that I am always happy to latch onto some current event in our dialogue.

When all is said and done, there is nothing except what is current, that is why it is so difficult to live in what we could call the world of reflection. It is because in truth not much happens there. I sometimes inconvenience myself to see if somewhere some little question mark is not appearing somewhere. I am rarely rewarded. That is why people pose me serious questions; well then, you will not blame me for taking advantage of it.

So I continue my dialogue with the person to whom I already alluded twice in my preceding seminars, in connection with the fashion, which I punctuated the last time, regarding the difference there is between the conception of the Hegelian articulation of desire and mine. I am being urged to say more about what is textually designated as a beyond to be accomplished in my own discourse, a more precise articulation between the mirror stage and, as the Rome report puts it, between the specular image and the signifier. Let us add that some hiatus (2) seems to remain there, not without my interlocutor glimpsing that perhaps here the use of the word hiatus, cut or split, is nothing other than the expected response. Nevertheless under this form, it might appear to be what it would be in effect: an eluding, or an elision. And that is why I will try quite willingly today to respond to him, and this all the more because we find ourselves there strictly on the path of what I have to describe for you this year concerning anxiety: anxiety is what is going to allow us to go over again, I am saying go over again the articulation thus required of me. I say go over again because those who have followed me these last years and even without

necessarily having been assiduous here at every point, those who have read what I wrote, have already more or less the elements to fill our, to make this cut, this hiatus function, as you are going to see from the few reminders with which I am going to begin.

In truth, I do not believe that there ever were two phases in what I taught: one phase which is supposed to be centred on the mirror stage, on something highlighted in the imaginary, and then after, with this moment of our history that is located by the Rome report, the discovery which I suddenly made of the signifier. In a text which I believe is no longer easy to get hold of but which can after all be found in any good psychiatric library, a text which appeared in L'évolution psychiatrique called Propos sur la causalité psychique, a discourse which takes us back, if I remember correctly, to just after the war in 1946, I would ask those who are interested in the question which is thus posed to me to consult it; they will see there things which will prove to them that it is not just now that the interplay between these two registers was closely woven by me.

In truth if this discourse was followed by a rather long silence, let us say that this should not astonish you too much. There was a road to travel afterwards to open a certain number of ears to this discourse, and you must not believe that at the time when - if that interests you, re-read these "Propos sur la causalité psychique" - that at the time when I made these remarks that it was easy to find ears to understand them.

(3) In truth, since it was at Bonneval that these Remarks were made and that a more recent meeting at Bonneval manifested to a certain number the distance that had been travelled since, you should be aware that the reactions to these first Remarks were rather astonishing. The modest term of ambivalence which we make use of in the analytic milieu, is the best way to characterise the reactions which I recorded to these Remarks, and even, because I am going to be queried about this subject, I do not find it absolutely useless to note that at a time, which a certain number of you were already sufficiently formed to remember, that at a time which was the time after the war and of some movement of renewal or other that one might have hoped from it and, I cannot help remembering all of a sudden, when I am brought back to that epoch, the fact indeed that those who were certainly not individually the least disposed to hear a discourse which was very new then, who were the people situated somewhere indeed that is called politically on the left, and even the extreme left, the Communists in fact to call them by their name, very specially demonstrated on this occasion the sort of thing, this reaction, this mode, this style, which I must pinpoint with a term that is in current use, which one should pause for a moment before putting forward - it is a very unjust term with respect to those who invoked it originally, but it is a term which ended up by taking on a meaning which is unambiguous, we will perhaps have to come back to it in what follows, I am employing it here in the courtly sense - it is the term of Pharisaism.

I would say that on that occasion, in this little glass of water which is our psychiatric milieu, Communist Pharisaism really operated flat out in the sense of what we saw being used for at least our present generation here in France, namely to ensure the permanence of this body of good or bad habits in which a certain established order finds comfort and security. In short, I cannot but bear witness to the fact that it was from the very special reservations that they showed, that I understood at that time that my discourse would take a long time to make itself heard. Hence the silence in question and the work that I have put in by devoting myself to making it penetrate simply the milieu whose experience rendered it most apt to hear it, namely the analytic (4) milieu. I will spare you the adventures that followed.

But this may make you re-read the Propos sur la causalite psychique. You will see, especially after what I told you today, that already the framework existed in which each one of the two perspectives that my interlocutor quite rightly distinguishes, was inscribed. These two perspectives are punctuated here by these two coloured lines, the vertical one in blue, the horizontal one in red - which the sign (I) of the imaginary and (S) of the symbolic respectively designate here.

There are many ways of reminding you that the articulation of the subject to the small other and the articulation of the subject to the big Other do not exist separately in what I am demonstrating to you. There is more than one way of showing it to you. I am going to remind you a certain number of moments which have already been illuminated, punctuated as essential in my discourse. I point out to you that what you see here on my blackboard, in the other lines that have been drawn, - you are going to see the elements involved being placed - is nothing other than a schema already published in the remarks that I thought I should make on the report of Daniel Lagache at Royaumont. And this drawing in which there is articulated something which has the closest relationship with our subject, namely the function of dependency of what - taking it from this report of Daniel Lagache but also from a previous discourse that I had given here in the second year of my seminar - of what I called respectively the ideal ego and the ego-ideal, yes, let us recall then how the specular relationship is inserted, finds itself therefore taking its place, finds itself depending on the fact that the subject is constituted in the locus of the Other. He constitutes himself from his mark in relationship to the signifier. Already, simply in the little exemplary image from which the demonstration of the mirror stage begins, in this so-called jubilatory moment when the infant assumes himself as a functioning totality as such in his specular image, have I not always recalled the essential relationship to this moment, of this movement which ensures that the little child who has just grasped himself in this inaugural experience of recognition in the mirror, turns back towards the one who is carrying him, who is supporting him, who sustains him, who is there behind him, towards the adult - turns back in a movement that is really so (5) frequent, I would say, so constant that each and every one of you, I think, may have the memory of this movement - turns back

towards the one who is carrying him, towards the adult, towards the one who here represents the big Other, as if to call in a way on his assent to what at this moment the child, the content of whose experience we are trying to assume, the sense of which moment we reconstruct in the mirror stage by referring it to this movement of the rotation (mutation) of the head which turns back and which returns towards the image, seems to demand of him to ratify the value of this image. Of course this is only an indication that I am recalling to you, given the inaugural link between this relationship to the big Other and the advent of the function of the specular image thus noted as always by $i(o)$. But do we have to remain at that? And, since it is within a work which I had asked of my interlocutor concerning the doubts which had come to him in connection specifically with what Claude Lévi-Strauss had put forward in his book La pensée sauvage, whose relation as you will see is really - I referred above to current events - close to what we have to say this year, for, I believe, what we have to tackle here, in order to mark this sort of progress which the usage of psychoanalytic reasoning constitutes, is something which happens to respond precisely to this gap where more than one of you for the moment have come to a halt, the one which throughout his development Claude Lévi-Strauss shows in this sort of opposition between what he calls analytic reasoning and dialectic reasoning.

And it is indeed in fact around this opposition that I would finally like to establish, at the present time, the following introductory remark which I have to make to you on my path today: what have I picked out, extracted, from the inaugural step constituted in the thinking of Freud by The interpretation of dreams if not the following - which I remind you of, which I stressed - that Freud first introduces the unconscious in connection with the dream precisely as a locus that he called eine anderer Schauplatz, a different scene of action (scène)? From the beginning, from the coming into play of the function of the unconscious, this term and this function are introduced into it as essential.

(6) Well then, I believe in effect that this is a constituting mode of what is, let us say, our reason, of this path that we are looking for to discern its structures, to make you understand what I am going to say to you. Let us say without further ado - it will be necessary to come back to it, because we do not yet know what it means - what the first phase is. The first phase, is: there is the world. And let us say that analytic reason, to which the discourse of Claude Lévi-Strauss tends to give the primacy, concerns this world as it is and grants it with this primacy a singular homogeneity, which is indeed what offends and disturbs the most lucid among you, who cannot help pointing out, discerning what this involves in terms of a return to what one could call a sort of primary materialism in the whole measure that at the limit, in this discourse; the very operation of the structure, of the combinatory, so powerfully articulated by the discourse of Claude Lévi-Strauss only rejoins for example the very structure of the brain, indeed the structure of matter, only represents, in accordance with the form described as the

materialism of the eighteenth century, the doublet, not even the understudy (doublure). I know well that this is only a perspective at the limit that we can grasp, but that it is worthwhile grasping it since it is in a way expressly articulated.

Now the dimension of the stage (*scène*), its separation from the locus, whether worldly or not, cosmic or not, where the spectator is, is there indeed to image to our eyes the radical distinction between this locus where things, be they the things of the world, where all the things of the world come to be spoken, to be staged in accordance with the laws of the signifier which we cannot in any way hold from the beginning to be homogeneous with the laws of the world. The existence of discourse and what ensures that we are implicated in it as subjects, is there only too obviously a long time before the advent of science, and the effort marvellous in its hopelessness that Claude Lévi-Strauss makes to homogenise the discourse that he calls that of magic with the discourse of science, is something which is admirably instructive, but which he cannot for a single moment push as far as the illusion that there is not here a moment, a cut, a difference; and I am going to emphasise in a little while what I mean by this and what we have to say about it.

(7) Therefore, first phase, the world. Second phase, the stage upon which we construct this world. And this is the dimension of history. History has always this character of a staging. It is indeed in this respect that the discourse of Claude Lévi-Strauss, specifically in the chapter where he responds to Jean-Paul Sartre, the final development that Jean-Paul Sartre establishes to realise this operation which I called the last time putting history back between its shafts.

The limitation of the range of the historical game, the reminder that the time of history is to be distinguished from cosmic time, that dates themselves take on all of a sudden a different value whether they are called 21 December or 18 Brumaire, and that ix. is not even the same calendar that we are dealing with as the one that you tear the pages off every day. The proof is that these dates have for you a different meaning, that they are re-evoked, when it is necessary, like any other day of the calendar as giving them their mark, their characteristic, their style of difference or of repetition. So then, once the stage has taken priority, what happens, is that the whole world is placed on it, that with Descartes, one can say: "I advance onto the stage of the world", as he does, "masked", and that starting from there the question can be posed of what the world owes, what we have called at the beginning quite innocently the world, what the world owes to what has come down to it again from this stage. And that which everything that we have called the world in the course of history and whose residues are superimposed on one another, piled up without moreover the slightest worry about contradictions, and that which culture brings us as being the world, which is a piling up, which is a warehouse of unclaimed objects, of worlds which have succeeded one another and because they are incompatible live only too comfortably together within

each one of us, a structure whose pregnancy and depth the particular field of our experience allows us to measure especially in that of the obsessional neurotic regarding whom Freud himself long ago remarked the degree to which these, these cosmic worlds, could co-exist in a fashion which apparently gives rise to no objections in him, while at the same time manifesting the greatest heterogeneity at a first approach, a first examination.

(8) In short, the putting into question of what the cosmic world is in the real is entirely legitimate, once we have referred to the stage. Is what we believe we have to deal with as world, not quite simply the accumulated remainders of what came down from the stage when - as I might put it - the stage was on tour? Well then, this reminder, this reminder is going to introduce to us a third remark, a third phase which I ought to recall to you as a prior discourse, and all the more, perhaps this time in an insistent way that it is not a phase, that I did not have enough time then to accentuate it. Because we are talking about a stage, we know what function precisely the theatre holds in the functioning of the myths which allow us analysts to think. I bring you back to Hamlet and to this crucial point which has already given rise to questions for a number of authors and more particularly for Rank who wrote on this point an article that was in every way, given the early period he produced it, an admirable article in every way, it is the attention that he drew to the function of the stage on the stage.

What does Hamlet, the Hamlet of Shakespeare, the Hamlet who is a stage character, what does Hamlet bring onto the stage with the players? No doubt the Mousetrap, the souriciere, with which, he tells us, he is going to lay hold of, to trap, the conscience of the king. But besides the fact that very strange things happen on it and in particular something which at the time, at the time when I was speaking to you at such length about Hamlet, I did not want to introduce to you because it would have oriented us towards a literature at bottom even more Hamletic - you know that this exists, that it exists to the point that there is enough of it to cover these walls - more Hamletic than psychoanalytic and that very strange things happen in it, including the following, namely that when this scene is mimed as a prologue before the players begin their speeches, well then, this does not seem to disturb the king much, even though nevertheless the presumed gestures of his crime are there pantomimed before him. On the contrary there is something very strange, it is the real overwhelming, the crisis of agitation which seizes Hamlet from a certain moment when there comes on the stage after a few speeches, when there comes the crucial moment, the one at which (9) the character named Lucianus or Luciano carries out, carries out his crime, on the one of the two characters who represents the king, the sham king (le roi de comedie), even though he had in his speech affirmed himself, assured himself as being the king in a certain dimension, as well as the one who represents his wife, his spouse; after the situation had been well established, all the authors who have paused at this scene, have remarked that the rig-out of the character is exactly, not that of the king

whom it is a question of trapping, but of Hamlet himself, and that moreover it is indicated that this character is not the brother of the sham king, is not in a relationship with him which would be homologous to the one of the usurper who is in the tragedy in possession of Queen Gertrude, after having carried out the murder, but in a position homologous to the one Hamlet has to this character, that it is the nephew of the sham king.

What, when all is said and done, does Hamlet cause to be represented there on the stage? It is himself, carrying out the crime in question, this character whose desire, for reasons that I tried to articulate for you, cannot be roused to accomplish the will of the ghost, of the fantome of his father, this character attempts to embody something; and what it is a matter of embodying passes by way of his image which is really specular here, his image not in the situation, the mode of carrying out his vengeance, but of assuming first of all the crime that must be avenged.

Now what do we see? That it is insufficient, that it is all very well for him to be seized, after this sort of magic lantern effect, by what one can really in his remarks, in his style, in the quite ordinary fashion moreover that the actors bring this moment to life, by a genuine little attack of maniacal agitation, when he finds himself a moment later with his enemy within his reach, he can only articulate something which for every listener has always been indeed something that could not be experienced as other than an evasion behind a pretext, it is that undoubtedly, he catches his enemy at a moment that is too holy - the king is praying - for him to decide by striking him at that moment, to make him go directly to heaven.

I am not going to delay by translating all that this means, because here I must go further. I want to advance enough today (10) and point out to you that alongside this failure - I strongly articulated this second phase at that time, I showed you its whole import - it is in the measure that an identification of a quite different nature which I called identification with Ophelia, it is in the measure that the furious soul that we can legitimately infer to be that of the victim, of the person who committed suicide, obviously offered as a sacrifice to the manes of her father - because it is after the murder of her father that she weakens, that she succumbs, but this shows us the age-old beliefs about the consequences of certain kinds of death from the very fact that the funeral ceremonies in her case, cannot be fully carried out - that there is no calming in the vengeance that she for her part is crying out for, that it is at the moment of the revelation of what this neglected, unrecognised object had been for him, that we see there being played out in Shakespeare in a completely open way this identification to the object that Freud designates for us as being the major mainspring of the function of mourning, this implacable definition, I would say, that Freud gave to mourning, this sort of reverse side that he designated to the tears which are consecrated to it, this ground of reproach that there is in the fact that all one wants of the reality of the one whom one has lost, is to want to remember the

sorrow that he has left behind. What astonishing cruelty and one well made to remind us of the legitimacy of more primitive celebrations that collective practices still are able to bring to life. Why not rejoice at the fact that he existed? The peasants whom we think are drowning an injurious insensibility in their banquets, are doing something quite different: it is the advent of the one who has been to the sort of simple glory that he merits, because of having been among us simply a living being. Let us not forget that this identification to the object of mourning that Freud has thus dedicated under its negative modes, has, if it exists, also its positive phase, that the entry into Hamlet of what I called here the fury of the feminine soul, is what gives him the energy to become, from then on, this sleepwalker who accepts everything, up to and including - I sufficiently marked it - being the one who holds the stakes in the fight, who takes the side of his enemy, the king himself, against his specular image who is Laertes. From then on, things will be settled all by themselves and without him doing in short (11) anything except exactly what should not be done, by leading him to what he has to do, namely that he should be himself mortally wounded, before killing the king. We have here, the distance, the difference that exists between two sorts of imaginary identification: 1) that of o:i(o), the specular image as it is given to us at the moment of the stage on the stage: 2) the more mysterious one whose enigma begins to be developed there, namely to something else, the object, the object of desire as such, designated without any ambiguity in Shakespeare's articulation as such because it is precisely as object of desire that it had been neglected up to a certain moment, that it is reintegrated on the stage by way of identification, precisely in the measure that as object it has just disappeared, that as one might say the retroactive dimension, this dimension of the imperfect in the ambiguous form that it is used in French, which is the one which gives its energy to the fashion in which I repeat before you the "il ne savait pas", which means: at the last minute did he not know, a little more and he would have known. This object of desire of which it is not for nothing that desire in French is said to be desiderium, namely this retroactive recognition, this object which was there, it is along this path that there is placed the return of Hamlet, that which is the high point of his destiny, of his function as Hamlet, if I can express myself thus, of his Hamletic completion, it is here that this third moment of reference to my previous discourse shows us where the questioning should be carried to, as you already know for a long time, because it is the same one that I am always renewing from multiple angles: the status of the object qua object of desire. Everything that Claude Lévi-Strauss says about the function of magic, about the function of myth, has its value on condition that we know that it is a matter of the relationship to this object which has the status of object of desire, a status which - I agree - is not yet established, which it is our object this year to make advance by taking the path of approaching it through anxiety and that it would be well all the same not to confuse this object of desire with the object defined by epistemology as the advent of a certain object scientifically defined as the advent of the object which is the object of our

science, very specifically defined, by a certain discovery of the (12) efficacy of the signifying operation as such, which is proper to our science - I am speaking about the science which exists among us for two centuries - leaves open the question of what I called above the cosmism of the object.

It is not sure that there is a cosmos and our science advances in the measure that it renounces preserving any cosmic or cosmising presupposition. We rediscover here this essential reference point, one which is so essential that one cannot fail to be astonished that in restoring under a modern form a type of permanence, of perpetuity, of the eternity of the cosmism of the reality of the object, Claude Lévi-Strauss, in La pensée sauvage does not bring to everybody the kind of security, of serenity, of Epicurean pacification which ought to result from it. The question is posed of whether it is only analysts who are not satisfied or whether it is everybody. Now I claim, even though I do not yet have proof of it, that it should be everybody. It is a matter of explaining why, why people are not content to see totemism suddenly, as one might say, emptied of what I might call in a gross way in order to make myself understood its emotional content, why are people not satisfied that the world should, since the Neolithic era - because one cannot go back any further than that - already be ordered in such a way that everything is only an insignificant little wave on the surface of that order, in other words, why do we want so much to preserve the dimension of anxiety. There must be some reason for that; because the bias, the passage which is here designated for us between this return to an assured cosmism and on the other hand the maintenance of an historical pathos which we do not hold with either all that much - even though it has precisely its function - it is indeed through the study of the function of anxiety that this path we are seeking must pass. And that is why I am led to remind you of the terms in which it can be seen how the specular relationship is precisely linked to the relationship with the big Other. In this article which I asked you to refer to, because I am not going to redo it here in its entirety, what the apparatus, the little image which I fomented to make understood what was involved, what this apparatus is designed for, is the following: it is to remind us of something I stressed at the end of my seminar on desire, it is that the function of specular cathexis is to be conceived of as situated within the dialectic of (13) narcissism as Freud introduced it.

This cathexis of the specular image is a fundamental moment of the imaginary relationship, fundamental in the fact that there is a limit and the fact is that the whole of libidinal cathexis does not pass through the specular image. There is a remainder. I already tried and, I hope, succeeded sufficiently in making you conceive how and why we can characterise this remainder under a central, pivotal mode, in this whole dialectic - and it is here that I will begin again the next time and show you how this function is more privileged than I have been able to make it up to now - under the mode, I am saying, of the phallus.

And that means that henceforth, in any imaginary mapping out,

the phallus appears in the form of a lack, of a (-\$>). In the whole measure that there is realised at $i(o)$ something that I called the real image, the constitution in the material of the subject of the image of the body functioning as properly imaginary, that is to say libidinised, the phallus appears as a minus, appears as a blank. The phallus no doubt is an operational reserve, but one which is not only not represented at the level of the imaginary but which is circumscribed and, in a word, cut out of the specular image.

Everything that I tried, last year, to articulate for you about the cross-cap is, to add a hinge to this dialectic, something which, in the ambiguous domain of topology, in so far as it slims down in an extreme way the data of the imaginary, in so far as it operates on a sort of trans-space which, when all is said and done, everything makes us think is made up of the worst signifying articulation, while at the same time still leaving within our reach some intuitive elements, precisely those supported by this misshapen and nevertheless very expressive image of the cross-cap which I manipulated before you for more than a month in order to make you conceive how on a surface defined in this way such as this one - I am not going to recall it here - the cut can establish two pieces, two different pieces, one which may have a specular image and the other which literally does not have one. The relation between this reservation, this reservation which is imaginarily ungraspable, even though it is linked, thank God, to a still perfectly graspable organ, namely (14) that of the instrument which ought all the same from time to time be brought into action for the satisfaction of desire, the phallus, the relationship between this ($-<p$) and the constitution of o which is this remainder, this residue, this object whose status escapes from the status of the object derived from the specular image, escapes from the laws of the transcendental aesthetic, this object whose status is so difficult for us to articulate that it is through it that there have entered all the confusions of analytic theory, this object o whose constituting characteristics we have only begun to outline and which we bring here onto the agenda, this object o , is the one which is at stake everywhere Freud speaks about object when anxiety is involved. The ambiguity comes from the way in which we cannot but imagine this object in the specular register. It is a matter precisely of establishing here - and we will do it, we are able to do it - to establish another mode of imaginisation, if I can express myself in this way, in which this object is defined. This is what we are going to be able to do, if you want to follow me, namely step by step. From what, in this article that I am speaking to you about, do I make the dialectic begin? From an S , the subject as possible, the subject because one must at least speak about him if one speaks, the subject whose model is given to us by the classical conception of the subject on this single condition that we limit him to the fact that he speaks, and, once he speaks, something is produced.

Once he begins to speak, the unary trait comes into play. The primary identification at this starting point constituted by the fact of being able to say one and one, and one again, and one

again and that it is always from a one that one must begin, it is starting from there - the schema of the article in question outlines it - starting from there that there is established the possibility of the recognition as such of the unit called $i(o)$. This $i(o)$ is given in specular experience; but as I told you, this specular experience is authenticated by the Other and as such, at the level of the sign $i(o)$. Remember my schema, I cannot here give you again the terms of the amusing little physics experiment which I made use of to be able to image it for you: $i'(o)$ which is the virtual image of a real image, at the level of this virtual image, nothing appears here.

(15) I wrote ($-\$>$) because we will have to bring it here the next time. ($-\$>$) is no more visible, is no more tangible, is no more presentifiable here than it is there, ($-\langle p$) has not entered into the imaginary. The initial, inaugural fate, the phase - I insist - of which we are speaking depends here on the following - which will have to wait for the next time for me to articulate it for you - that desire depends on the relationship that I gave you as being that of the phantasy, the diamond, with its meaning that we will learn how to read in a still different way soon, o: o

This means that it would be in the measure that the subject could really be - and not through the mediation of the other - at the place of I that he would have a relationship with what it is a matter of taking in the body of the original specular image $i(o)$, namely the object of his desire, here, these two pillars, are the support of the function of desire, and if desire exists and sustains man in his existence as man, it is in the measure that this relationship is accessible by some detour, that the artifices give us access to the imaginary relationship that the phantasy constitutes. But this is in no way possible in an effective fashion. What man is confronted with, is never anything but the image of what in my schema I represented - as you know or as you do not know - by $i'(o)$ that the illusion of this spherical mirror produces; here in the real state, in the form of the real image, he has its virtual image with nothing in its body [neck?]. The o, support of desire in the phantasy, is not visible in what constitutes, for man, the image of his desire.

This presence elsewhere therefore, on this hither side, and, as you see here, too close to him to be seen, as one might say, of the o, this is the initium of desire; and it is from that that the image $i'(o)$ takes on its prestige. But the more man approaches, circumscribes, caresses what he believes to be the object of his desire, the more in fact he is deviated, turned aside from it, precisely because of the fact that everything that he does on this path in order to get closer to it, always gives more body to what in the object of this desire represents the specular image. The further he goes, the more he wants, in the object of his desire, to preserve, to maintain - listen carefully to what I am telling you - to protect - this is the intact aspect of this primordial vase which the specular image is - the more he (16) engages himself on this path which is often incorrectly called the path of the perfection of object relations, the more

he is deceived.

What constitutes anxiety, is when something, a mechanism, makes there appear here at what I would call to make myself understood simply its natural place, at the place which corresponds to the one occupied by the object of desire, something - and when I say something, you should understand anything whatsoever - I would ask you, between now and the next time, to take the trouble, with this introduction that I am giving you to it to reread the article on the Unheimlich. It is an article which I have never heard anyone giving a commentary on, never, never heard a commentary on, and which no-one seems even to glimpse as being the absolutely indispensable hinge for approaching the question of anxiety.

Just as I approached the unconscious by the witticism, I will approach anxiety this year by the Unheimlich, it is what appears at this place. This is why I have written it for you from today: it is the **(-9)**, the something which reminds us that what everything starts from is imaginary castration, that there is no - and for good reason - image of lack. When something appears there, it is because, if I can express myself in this way, that the lack is lacking. Now this may appear to be simply a joke, a concetti (?) which is well placed in my style which everyone knows is Gongoric. Well, I don't give a damn. I would just like to point out to you that many things can appear which are anomalous, this is not what makes us anxious. But if all of a sudden all norms are lacking, namely what constitutes the lack - because the norm is correlative to the idea of lack - if all of a sudden it is not lacking - and believe me try to apply that to a lot of things - it is at that moment that anxiety begins.

So that already I authorise you to take up again the reading of what Freud says in his last great article on anxiety, that of Inhibitions, symptoms and anxiety, from which we have already begun for a first outline. Then with this key, you will see the true sense to be given, in his writing, to the term of loss of object. It is here that I will take things up again the next time, and where I hope to give its true sense to our research for this year.

So then, I am again putting on the blackboard for you this figure, this schema by means of which I engaged myself with you the last time in the articulation of what is our object, namely through anxiety - I am saying its phenomenon, but also by the place that I am going to teach you to designate as being its own - to go thoroughly into the function of the object in analytic experience.

Briefly I want to point out to you that there will soon appear

Seminar 4: Wednesday 5 December 1962

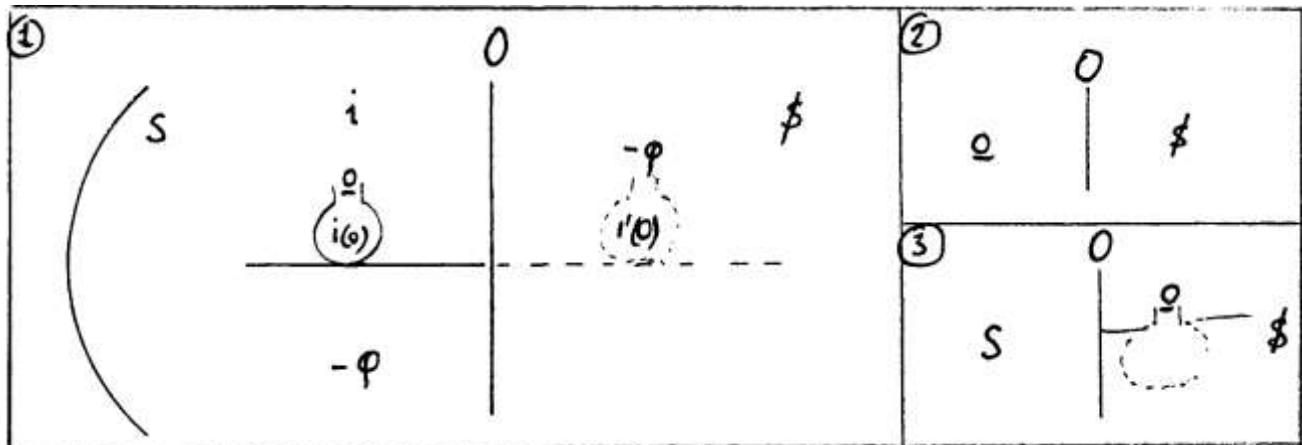

something that I took the trouble to write up from an intervention, from a communication I made - it is more than two years ago now, it was the 21st of September 1960 - at a Hegelian meeting at Royaumont, at which I had chosen to treat of the following subject: "Subversion of the subject and dialectic of desire in the Freudian unconscious". I point out to those who have already familiarised themselves with my teaching that in sum I think they will find there complete satisfaction as regards the phases of construction and the utilisation, the functioning, of (2) what together we have called the graph. This is published at a centre at 173 Boulevard, Saint Germain and which is responsible for publishing all the work of Royaumont. I think that this work will soon appear in a volume which will also include the other interventions - which are not all especially analytic - which were made in the course of this meeting centred, I repeat, on Hegelianism.

It is appropriate to mention this today in the measure that subversion of the subject, like dialectic of desire, is what frames for us this function of the object into which we are now going to have to advance more deeply.

In this respect, especially for those who come here as novices, I do not think that I could encounter in any way what I have to call the very antipathetic reaction that I still remember greeted the work of this title, as I told you, at the Royaumont Congress on the part, to my astonishment, of philosophers whom I believe more hardened to welcoming the unusual and who undoubtedly in something which was precisely constructed to put before them very profoundly the function of the object - and specifically the object of desire - ended up on their part with an impression that I cannot qualify otherwise than in the way they described it themselves: that of a sort of nightmare, indeed even of a lucubration emerging from a certain diabolism.

Does it not appear all the same that everything in an experience that I would call modern, an experience at the level of what there is brought in terms of profound modifications in the apprehension of the object, by the era, that I am not the first to describe as the era of technique, should that not bring to you the idea that a discourse on the object must necessarily pass by way of complex relationships which do not permit us to accede to it except by way of profound chicanery? Can one not say that for example this module of object, so characteristic of what is given to us - I am speaking about the most external experience, I am not talking about analytic experience - this module of object which is called the spare part, is it not something which deserves to be dwelt on and something which brings a profoundly (3) new dimension to every noetic interrogation concerning our relationship to the object? For after all what is a spare part? What is its subsistence outside its eventual use with respect to a certain model which is functioning, but which can also moreover become obsolete, no longer be repeated as they say? After that what becomes of, what meaning has a spare part?

Why should this profile of a certain enigmatic relationship to the object not be of use to us today as an introduction, as a reminder of something which is not a vain complication, that there is no need for us to be astonished or to steel ourselves against a schema, against a schema like this one which I recalled for you and already introduced the last time, and that the result is that it is at that place, at the place where in the Other, at the locus of the Other, authenticated by the Other, there is profiled an image of ourselves that is simply reflected, already problematic, even fallacious; that it is at a place that is situated with respect to an image which is characterised by a lack, by the fact that what is called for there cannot appear there, that there is profoundly orientated and polarised the function of this image itself, that desire is there, not simply veiled, but essentially placed in relation to an absence, to a possibility of appearing determined by a presence which is elsewhere and determines it more closely, but, where it is, ungraspable by the subject, namely here, I indicated it, the o of the object, of the object which constitutes our question, of the object in the function that it fulfills in the phantasy at the place that something can appear. The last time I put this sign (-), in parentheses, pointing out to you that here there ought to be profiled a relationship with the libidinal reserve, with

the something which is not projected, with the something which is not cathected at the level of the specular image, for the reason that it remains profoundly cathected, irreducible at the level of one's own body, at the level of primary narcissism, at the level of what is called erotism, at the level of an autistic jouissance, an aliment in short remaining there for what will intervene eventually as instrument in the relationship to the other, to the other constituted starting from this image of my fellow, this other who will profile with its form and its norms the image of the body in its seductive function on the one who is the sexual partner.

(4) Therefore you see there being established a relationship: what, as I told you the last time, can come to be distinguished at this place designated here by the (-jp), is anxiety, castration anxiety in its relationship to the Other. The question of this relationship to the Other is the one into which we are going to advance today. Let us say right away - you see, I am going straight to the nodal point - that everything that we know about this structure of the subject, about this dialectic of desire which is the one that we analysts have to articulate, something absolutely new, original about, we learned through what, along what path? Along the path of the experience of the neurotic. And what has Freud told us? It is that the final term that he arrived at in elaborating this experience, the term which he points out to us as being for him his destination, his end point, the unsurpassable term for him, is castration anxiety.

What does that mean? Is this term unsurpassable? What is meant by this stopping of the analytic dialectic on castration anxiety? Do you not already see, in the simple usage of the schema that I am using, there being outlined the way that I intend to lead you? It begins from a better articulation of this fact of experience, designated by Freud in the neurotic's coming to a halt before castration anxiety. The opening that I am proposing to you consists in the fact that the dialectic that I am showing you here allows to articulate: the fact is that it is not at all castration anxiety in itself which constitutes the final impasse of the neurotic; because the form, the form of castration, of castration in its imaginary structure, is already constructed here in the approach to the libidinated image of my fellow, it is constructed at the level of the breaking that is produced at some time because of a certain imaginary drama; and this - as you know - is what gives importance to the accidents of the scene which for that reason is described as traumatic. There are all sorts of variations, of possible anomalies, in this imaginary break which already indicate something in the material, that can be used for what? For another function which, for its part, gives its full sense to the term castration.

What the neurotic retreats from, is not castration, it is from making of his own castration what is-lacking to the Other, 0, it is from making of his castration something positive which is the (5) guarantee of this function of the Other. This Other which slips away in the indefinite putting off of significations, this Other which the subject no longer sees as anything but destiny,

but a destiny which has no end, a destiny which loses itself in the sea of histories - and what are histories, if not an immense fiction - what can ensure a relationship of the subject to this universe of significations, if not that somewhere there is jouissance? He can only ensure this by means of a signifier, and this signifier is necessarily lacking. It is the topping up that the subject is called on to make at this missing place by a sign which we call on from his own castration.

Dedicating his castration to this guarantee of the Other is what the neurotic comes to a halt before; he comes to a halt before it for a reason that is in a way internal to analysis: the fact is that analysis brings him to this rendezvous. When all is said and done castration is nothing other than the moment of the interpretation of castration.

I have perhaps been quicker than I intended to be in my discourse this morning. In any case you see it indicated there that perhaps there is a possible way through, but of course we can only explore this possibility by going back to this very place at which imaginary castration functions, as I have just pointed out to you, in order to constitute properly speaking with all its rights what is called the castration complex.

It is therefore at the level of the putting in question of this castration complex that our whole concrete exploration of anxiety, this year, is going to allow us to study this possible way though, one all the more possible in that it has already been taken on several occasions. It is the study of the phenomenology of anxiety which is going to allow us to say how and why.

Anxiety, which we take in its minimal definition as a signal, a definition which even though it comes at the end of the progress of Freud's thinking is not what people believe, namely the result of an abandoning of the first positions of Freud which made of it the fruit of an energetic metabolism, neither an abandoning, nor even a new conquest; because at the time when Freud made of anxiety the transformation of the libido, there is already the indication that it could function as a signal. This would be (6) easy to show you in passing by consulting the text. I have too much to do, to bring up this year with you concerning anxiety, to become bogged down too long at the level of this explanation of text.

Anxiety, as I told you, is linked to everything that can appear at that place; and what assures us of this, is a phenomenon which because it has been accorded too little attention has meant that we have not arrived at a satisfying, unitary formulation of all the functions of anxiety in the field of our experience. This phenomenon, is Unheimlichkeit. I asked you to refer to Freud's text the last time, and for the same reasons; it is because I do not have the time to spell out this text with you again. Many of you, as I know, went at it right away, for which I thank them. The first thing which stands out in it even on a superficial reading, is the importance that Freud gives to linguistic analysis. If it were not everywhere obvious, this text would be

enough just by itself to justify the importance that I give to the functions of the signifier in my commentary of Freud. The thing which will stand out secondly, when you read the way in which Freud introduces the notion of the unheimlich, the exploration of dictionaries concerning this word, is that the definition of unheimlich is to be un-heimlich. It is what is at the high-point of Heim, that is Unheim. And then since he has only to explain to us why it is like that, because it is very-obvious by simply reading the dictionaries, he does not delay any longer on it; he is like me today; he has to advance. Well then, for our conventions, for the clarity of our language, for what follows, this place designated here the last time, we are going to call by its name: this is what is called Heim. If you wish, let us say that if this word has a meaning in human experience, this is where the home of man is. Give to this word home (maison) all the resonances you wish, including the astrological ones. Man finds his home in a point situated in the Other beyond the image of which we are made and this place represents the absence where we are. Supposing - which happens - that it reveals itself for what it is: the presence elsewhere which constitutes this place as absence, then it is the queen of the game. It makes off with the image which supports it and the specular image becomes the image of the double with what it (7) brings in terms of a radical strangeness and, to employ terms which take on their signification by being opposed to the Hegelian terms, by making us appear as object by revealing to us the non-autonomy of the subject. Everything that Freud picked out as example in the Hoffmann texts which are at the heart of such an experience: the Sand-Man and his atrocious story in which one sees the subject rebounding from captivation to captivation before this form of image which properly speaking materializes the extremely reduced schema that I give you of it here, but the doll in question, which the hero of the story spies behind the window of the sorcerer who carries out some magical operation or other on her, is properly this image % '» in the operation of

completing it by what is in the very form of the story absolutely distinguished, namely the eye. And the eye involved can only be that of the hero of the story. The theme of this eye which is to be stolen from him, is what gives the explanatory thread of the whole story.

It is significant of some embarrassment or other linked to the fact that it was the first time that the ploughshare entered onto this line of the revelation of subjective structure, that Freud gives us in a way this reference in an unpackaged way. He says: "read The Devil's Elixir". I cannot even tell you how complete it is, the degree to which it contains all the possible forms of the same mechanism in which there are made explicit all the incidences in which this function can be produced, in which there can be produced this unheimlich reaction. Obviously he does not go into it, he is in a way overcome by the luxuriance that is effectively presented by this short little novel which it is still not so easy to get a copy of, even though by the goodness of someone, I still do not know who, among those present I find I have one - and I thank you for it or at least I thank the person

in question - on this lectern. It is very useful to have more than one copy at one's disposal.

On this point, Heim does not manifest itself simply, as you have always known, namely that desire is revealed as the desire of the Other, here desire in the Other, but I would say that my desire enters the den where it has been awaited from all eternity in the shape of the object that I am, in so far as it exiles me from my subjectivity by resolving of itself all the signifiers to which (8) this subjectivity is attached. Naturally that does not happen every day, and perhaps even it only happens in the tales of Hoffmann. In The Devil's Elixir it is quite clear. At every detour of this long and so tortuous truth, we understand from the note that Freud gives, which allows it to be understood that one loses oneself a little in it and even this "losing oneself in it" is part of the function of the labyrinth that must be brought to life. But it is clear that, even though everyone makes this detour, the subject only arrives at, only accedes to, his desire by substituting himself always for one of his own doubles.

It is not for nothing that Freud insists on the essential dimension which the field of fiction gives to our experience of the unheimlich. It is too fleeting in reality and fiction demonstrates it much better, produces it even in a more stable fashion because it is better articulated. It is a sort of ideal point, but one very precious for us, since, from that point on, we are going to be able to see the function of phantasy. This possibility, articulated repeatedly in a work like the Devil's Elixir, but locatable in so many other authors, of the major effect of fiction, this effect in the effective current of existence is what remains we can say at the state of phantasy. And what is phantasy taken from this angle if not - which we have some doubts about - ein Wunsch, a wish and even, like all wishes, rather naive. To express it rather humorously, I would say that S desire of o, the formula of the phantasy, can be translated, in this perspective, that the Other faints, swoons, I would say, before this object that I am, a deduction made from the fact that I see myself.

Here then, because I cannot avoid posing things like that in an apodictic way, and then afterwards you will see how it functions, I will tell you right away to declare my hand that the two phases in which I wrote the relationships of S to o by situating them differently with respect to the reflective function of O. With respect to this mirror O, these two fashions correspond exactly, to the fashion, to the redistribution of the terms of the



(9) might say to express myself very roughly to make myself understood - in their proper place: the o is there where it is,

phantasy in the pervert and in the neurotic. Things are - as I

where the subject cannot see it, as you know, and the \$ is at its place. That is why one can say that the perverse subject, while remaining unconscious of the way in which this functions, offers himself loyally to the jouissance of the Other. Only, we would never have known anything about it, if there were not neurotics for whom phantasy has absolutely not the same function. So that it is at the same time he who reveals it to you in its structure because of what he makes of it, but with what he makes of it, through what he makes of it, he screws you like he screws everybody else. Because, as I am going to explain to you, he makes use of this phantasy for very particular ends. This is what I already expressed before you on other occasions, by saying that what was believed to have been perceived as being a perversion under the neurosis, is simply what I am in the process of explaining to you, namely a phantasy entirely situated at the locus of the Other, the support taken upon something which, if one encounters it, is going to present itself as perversion.

Neurotics have perverse phantasies, and that is why analysts have racked their brains for a long time asking themselves what that means. It can be clearly seen all the same that it is not the same thing, that it does not function in the same way. Hence the question which is engendered and the confusions which multiply about the question of whether, for example a perversion is really a perversion, namely whether it does not function as a question which reduplicates the following: namely of what use the perverse phantasy is to the neurotic? Because there is all the same one thing that, starting from the position of the function that I have just set up before you of the phantasy, one must begin by saying, it is that this phantasy that the neurotic makes use of, that he organises at the moment that he makes use of it - there is indeed in effect something of the order of o which appears at the place of Heim, above the image that I designate for you, the locus of the appearance of anxiety - well then, there is something altogether striking which is that, precisely, this is what serves him best to defend himself against anxiety, to cover up the anxiety.

There is therefore - this can only be conceived naturally starting from presuppositions which I had to pose at first in their extreme form, but like every new discourse, you have to (10) judge it at the moment that it takes shape and see whether it covers (as I think you have no doubt) the functioning of experience - this object o which the neurotic puts into his phantasy, suits him, I would say, the way gaiters suit a rabbit. This indeed is why the neurotic never makes very much of his phantasy. It succeeds in protecting him against anxiety precisely in the measure that it is a false o. It is the function that I illustrated for you a long time ago of the dream of "the butcher's beautiful wife". The butcher's beautiful wife loves caviar; only she does not want it because this might give too much pleasure to her big brute of a husband who is capable of swallowing that with the rest, even that would not stop him. Now what interests the butcher's beautiful wife, is not at all of course to feed her husband with caviar, because, as I told you, he would add a whole menu to it, because he has a huge appetite,

the butcher. The only thing that interests the butcher's beautiful wife is that her husband should want the little nothing that she holds in reserve.

This formula is quite clear when we are dealing with a hysteric; believe me today: it applies to all neurotics. This object of functioning in their phantasy, and which serves as a defense for them against their anxiety, is also, despite all appearances, the bait with which they hold onto the other. And thank God for it: it is to this that we owe psychoanalysis.

There was a lady named Anna O who knew something about the operation of the hysterical game and who presented her whole story, all her phantasies, to Messrs Breuer and Freud who precipitated themselves onto it like little fish into water. Freud on I no longer remember what page, 271, of Studien iiber Hysterie marvelled at the fact that in Anna O all the same there was not the slightest defense. She gave everything she had, just like that. There was no need to work very hard to have the whole package. Obviously he found himself before a generous form of hysterical functioning. And it was for that reason that Breuer, as you know, really felt it going down; because he, along with the formidable bait also swallowed the little nothing, and he spent some time trying to regurgitate it. He stayed well away from it in future.

(11) Luckily Freud was neurotic. And since he was both intelligent and courageous, he knew how to make use of his own anxiety about his desire - which was at the source of his ridiculous attachment to this impossible woman who as a matter of fact buried him called Madame Freud - and he knew how to make use of it to project onto the X-ray screen of his fidelity to this phantastical object, to recognise in it without blinking even for an instant what it was a question of doing, namely to understand what use all of this was and well and truly to admit that Anna O had perfectly in her sights, Freud himself, but that he was obviously a little bit harder to have than the other, Breuer. It is indeed to this that we owe our entry through phantasy into the mechanism of analysis and into a rational use of the transference.

It is perhaps also what is going to allow us to take the next step and to perceive that what constitutes the border between the neurotic and the others - a new leap whose passage I would ask you to note, since like the others we are going to have to justify it subsequently - what effectively functions in the neurotic, is that at this level already displaced for him, of the object is something which is already sufficiently explained by the fact that he was already able to transport the function of it into the other. The reality that exists behind this fallacious use of the object in the phantasy of the neurotic has a very simple name: it is the demand.

The true object the neurotic seeks is a demand: he wants a demand to be made of him, he wants to be begged. The only thing that he does not want is to pay the price. This is a gross experience

which analysts have no doubt not sufficiently taken apart, illuminated by Freud's explanations, for them not to have believed it necessary to return here to the slippery slope of moralism and to deduce from it a phantasy which can be found everywhere in the oldest moralistic-religious preachings, that of oblativity.

They have obviously glimpsed that, since he wants to give nothing, this has a certain relationship also with the fact that his difficulty is in the order of receiving. He wants to be begged, I told you, and does not want to pay the price. While if he really wished to give something, perhaps it would work. Only, do the analysts in question, those who speak so beautifully about (12) genital maturity - as if this were the locus of the gift - not perceive that what the neurotic must be taught to give, is this thing that he does not imagine, it is nothing, it is precisely his anxiety. This is what leads us to our point of departure today designating the coming to a stop on castration anxiety. The neurotic will not give his anxiety. We will learn more about it: we will learn why. It is so true that this is what is involved, that all the same the whole process, the whole chain of analysis consists in the fact that at least he gives its equivalent, that he begins by giving his symptom a little. And this is why an analysis, as Freud says, begins by a putting into shape of symptoms. We are indeed at the required place and we try to catch him, God knows, in his own trap. You can never do anything other with someone. He makes you what is really a fallacious offer, well then one accepts it. By this one enters into the game through which he appeals to the demand. He wants you to demand something of him. Since you demand nothing of him - this is how the first entry into analysis takes place - he begins to modulate his own, his demands, which come there at the place Heim. And I tell you in passing: I find it hard to see, outside what is articulated almost by itself on this schema, how one has been able to justify up to now, except by a sort of false, gross comprehensibility, the dialectic of frustration-aggression-regression. It is in the measure that you leave the demand without an answer that there begins to be articulated here, that there begins to be produced what? The aggression involved. Where have you ever seen, except outside analysis in practices described as group psychotherapy that we have heard tell of, no aggression being produced? But on the contrary the dimension of aggressivity comes into play to put in question again what it aims at by its nature, namely the relationship to the specular image.

It is in the measure that the subject exhausts his rages against this image that there is produced this sequence of demands which goes always towards a more original demand historically speaking, and regression as such is modulated.

The point at which we arrive now and which also has never been explained up to now in a satisfactory fashion, is how it happens that it is along this regressive path that the subject is led to a moment that we are indeed forced to situate historically as progressive. There are those who, placed before this paradox of

how it is that by going back to the oral phase one separates out the phallic relationship, have tried to make us believe that after the regression one should retrace one's steps in the opposite direction, which is absolutely contrary to experience. There has never been an analysis, no matter how successful it is supposed to have been in the process of regression, which repassed through the opposite stages, which would be necessary if it were something like a genetic reconstruction that was involved. On the contrary it is in the measure that there are exhausted to the end, to the bottom of the barrel, all the forms of demand, including the zero demand, that we see appearing at the bottom the relation to castration.

Castration is found inscribed as a relation at the limit of this regressive cycle of demand. It appears there immediately afterwards and in the measure that the register of demand is exhausted. It is this that must be understood topologically.

I do not want to push things any further today. But all the same I will end with a remark which since it converges with the one on which I ended my last discourse will take your reflection in a direction which will facilitate for you the next step as I have just now highlighted it. And here again I am not going to delay on useless detours, I am going to take things right at the centre. In Inhibitions, symptoms and anxiety, Freud tells us, or appears to tell us, that anxiety is the reaction, the signal-reaction to the loss of an object; he enumerates that of the all enveloping uterine milieu, which happens at birth, eventually that of the mother considered as object, that of the penis, that of object-love and that of the love of the super-ego.

Now what did I tell you the last time to put you already on a certain path that is essential to grasp, if not that anxiety is not the signal of a lack but of something that you must manage to conceive of at this redoubled level as being the absence of this (14) support of the lack. Well then, take up again Freud's very list that I take here arrested at its term in full flight, as I might say: do you not know that it is not nostalgia for what is called the maternal womb which engenders anxiety, it is its imminence, it is everything that announces to us something which will allow us to glimpse that we are going to re-enter it. What provokes anxiety? It is not, contrary to what is said, either the rhythm nor the alternation of the presence-absence of the mother. And what proves it, is that the infant takes pleasure in repeating this game of presence and absence: this possibility of absence, is what gives presence its security. What is most anxiety-provoking for the child, is that precisely this relation of lack on which he establishes himself, which makes him desire, this relation is all the more disturbed when there is no possibility of lack, when the mother is always on his back, and especially by wiping his bottom, the model of the demand, of the demand which cannot fail. And at a higher level at the following phase, that of the so-called loss of the penis, what is involved? What do we see at the beginning of little Hans' phobia?

The following, that what the accent is put on, what is not well

centred, namely that anxiety is supposed to be linked to the interdiction by the mother of masturbatory practices, is experienced, perceived by the child as the presence of the desire of the mother being exercised towards him. What is anxiety in general in relation to the object of desire, what does experience teach us here, if not that it is temptation, not the loss of the object, but precisely the presence of the fact that objects are not lacking? And to pass to the following stage, that of the love of the super-ego with everything that it is supposed to pose along what is called the path of failure, what does that mean, if not that what is feared, is success, it is always the "it is not missing, ca ne manque pas"?

I will leave you today on this point designed to make you get around a confusion which precisely reposes entirely on the difficulty of identifying the object of desire. And it is not because it is difficult to identify that it is not there: it is there and its function is decisive for what concerns anxiety.

(15) You should consider that what I told you today is still only a preliminary way in, that the precise mode of situating it that we will go into from the next time is therefore to be situated between three themes that you have seen being outlined in my discourse today: one is the jouissance of the Other, the second the demand of the Other, the third could only be heard by the sharpest ears. It is the following, this sort of desire which manifests itself in interpretation, of which the very incidence of analysis in the treatment is the most exemplary and the most enigmatic form, the one which has made me pose the question for a long time for you: "In this essential economy of desire, what does this sort of privileged desire which I call the desire of the analyst represent?"

Seminar 5: Wednesday 12 December 1962

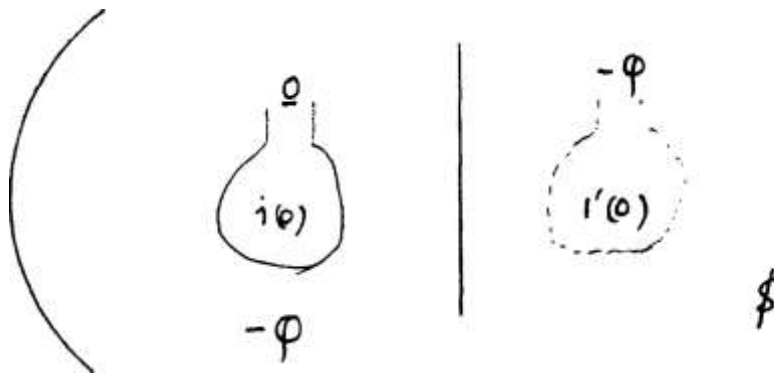

We have seen, we have read, we will see and read again that a certain way of teaching psychoanalysis, specifically the one that is pursued here, has a supposedly more philosophical character than another type which is supposed to try to connect up with a more concrete, more scientific, more experimental experience. It does not matter what word one uses.

It is not my fault, as they say, if psychoanalysis, on the theoretical plane, puts in question the desire to know, and therefore places itself, already places itself in its discourse on the hither side, in what precedes the moment of knowledge which joined by itself would already justify this sort of putting in question which gives to our discourse, what we might call a certain philosophical hue.

For that matter moreover, I was preceded in this by the inventor of psychoanalysis himself who was indeed, as far as I know, someone who was at the level of a direct experience, that of patients, of mental patients, of those especially that are called with a greater rigour since Freud, neurotics.

But after all, this would not be a reason for remaining any longer than necessary on an epistemological questioning, if the place of desire, the way in which in which it hollows itself out (se creuse), was not at every instant - at every instant in our therapeutic position - presentified for us through a problem, which is the most concrete one of all, that of not allowing ourselves to engage on a false path, of not responding to it in the wrong way, of not responding inexactly to it, at least of considering recognised a certain goal that we pursue and which is not so clear. I remember having provoked indignation in the sort of colleague who knows on occasion how to barricade himself

(2) behind some bombast or other of fine sentiments designed to reassure someone or other, to have provoked indignation by saying that in analysis a cure only came in a way as a bonus.

This was seen as some sort of disdain for the one that we are responsible for, the person who is suffering. I was speaking from a methodological point of view. It is quite certain that our justification as well as our duty is to ameliorate the position of the subject. And I claim that nothing is more uncertain in the field that we are in than the concept of a cure.

Is an analysis which ends with the entry of the male or female patient into the third order a cure, even if the subject finds himself improved as regards his symptoms, and in a certain way, a certain order that he has reconquered enunciates the most express reservations about the ways, now seen by him as perverse, through which we have made him pass in order to make him enter the kingdom of heaven.

This happens. That is why I do not think I am deviating for a single instant from our experience. My discourse, very far from deviating from it, consists precisely in recalling that within our experience every question can be asked, and that it is necessary, precisely, for us to preserve in it the possibility of a certain thread which, at least for us, guarantees us that we are not cheating on what is our very instrument, namely the plane of truth.

This necessitates of course an exploration which must not only be serious, but I would say up to a certain point to be, not simply a....., but - what it can be - but to a certain degree, yes, encyclopedic.

It is not easy in a subject like anxiety to gather together in a discourse like mine this year what, let us say, for psychoanalysts ought to be functional, what they, ought not to forget for a single instant about what is important to us. We have designated on this little schema the place currently occupied by as the place of anxiety, as this place which I already designated as constituting a certain void, anxiety appearing there about everything which manifests itself at this place, to confuse us, as I might say, as regards the structuring function of this void.

The signs, as I might put it, the indices to be more exact, the import of this tautology will only have value if we can find them confirmed by some approach or other which has been given by (3) every serious study of the phenomenon of anxiety, whatever its presuppositions might be. Even if these presuppositions appear too narrow for us, should be situated within this radical experience which is ours, it remains that something has been well grasped at a certain level and even if the phenomenon of anxiety appears to us to be limited, distorted, insufficient in the light of our experience, we should at least try to learn why it is that way. Now it is not always that way. We have to

harvest ctt any level whatsoever where there has been formulated up to the present the questioning about the subject of anxiety.

It is my intention today to indicate, because I am not able, of course, to add together something that would require a whole year of seminars, to add together what has been contributed in a certain number of types of questioning which are called - rightly or wrongly - for example the objective approach to the problem of anxiety, the experimental approach to the problem of anxiety.

And of course, we would only lose ourselves in these responses, if I had not given you at the beginning the lines of sight, the orientation points that we cannot abandon for a single moment in order to guarantee, to restrict our object, so that we can see what conditions it in the most radical, the most fundamental fashion. And it is for this reason that the last time, my discourse ended by circumscribing them, as one might say, with three reference points which I had of course only started on, to introduce three points where undoubtedly, the dimension of the Other remained dominant. Namely the demand of the Other, the jouissance of the Other and, in a quite modal form which remained moreover at the state of a question mark, the desire of the Other in so far as it is this desire which corresponds to our interrogation, I mean that of the analyst, of the analyst in so far as he intervenes as term.

We are not going to do what we reproach all the others with doing, namely elide ourselves from the text of the experience which interrogates us. The anxiety to which we have here to bring a formula, is an anxiety which responds to us, it is an anxiety that we provoke, it is an anxiety to which we have on occasion a determining relationship.

This dimension of the Other where we find our place, our efficacious place in so far precisely as we know how not to restrict it - which is the motive of the question that I am (4) posing, namely the measure in which our desire ought not to narrow it - this dimension of the Other, I would like to make you sense that it is not absent from any of the modes under which up to now an attempt has been made to circumscribe, to get closer to, this phenomenon of anxiety. And I would say that at the point of mental exercise that I have formed, habituated you to, perhaps indeed you may see the vanity in this sort of bombast, of vain success, of false triumph that some people find themselves taking in the fact that, for example, supposedly in opposition to analytic thinking - and again would it even be that, when all is said and done - neuroses are produced in animals in the laboratory, on the experimental bench. These neuroses, those which the Pavlovian laboratory, I mean Pavlov himself and those who followed him,, emphasised on occasion, what do they show us? We are told that in the text and the sequence of these experiments by which one conditions what is called one or other reflex of the animal, namely one or other "natural reaction" of one of these systems which are associated to a stimulus, to an excitation which forms part of a register

presumed to be completely different from the one which is involved in the reaction, by a certain mode of making these conditioned reactions converge, we are going to take into account the effect of contrariety. Once we have already obtained, conditioned, produced one of these responses of the organism, we are going to put it in a position of responding at the same time in two opposed ways, generating as one might say a sort of organic perplexity.

To go further, we would even say that in certain cases we can, we have the idea that what we are obtaining is a sort of exhaustion of the possibilities of response, a sort of more fundamental disorder generated by their confusion, something which involves in a more radical fashion what one can call the ordinary field of the reaction involved, which is the objective expression of what can be interpreted in a more general perspective as defined by certain modes of reaction which are called instinctual. In short, to get to the point where the demand made on the function - it is something which has been theorised more recently and in different cultural areas, by the term stress - may end up, culminate in the sort of deficit which overwhelms the function itself, which involves the system in a way which modifies it, beyond the register of the functional response, which is more or less close, in the lasting traces that it engenders, to a lesional deficit.

(5) It would no doubt be important to highlight in this range of experimental interrogation, where, properly speaking, there is manifested something which reminds us among neurotic reactions of the form described as "anxiety ridden". There is nevertheless something which appears to be eluded in such a way of posing the problem of the experiment. Eluded in a way for which it is no doubt impossible to reproach the reporter of these experiments for eluding, because this elision is constitutive of the experiment itself. But for someone who has to connect this experiment to our experience, namely the one which happens with a speaking subject - this is the importance of this dimension in so far as I remind you of it - it is impossible not to notice the following, that however primitive may be the animal organism thus interrogated compared to that of the speaking subject - and these organisms are far from being primitive, from being distant from our own in the Pavlovian experiments, because they are dogs - the dimension of the Other is present in the experiment.

It is not today or yesterday that intervening for example during one of our scientific meetings on some phenomena which were brought to us - I cannot go over them again today - concerning the creation of experimental neurosis, I pointed out to the one who was communicating his researches, that his own presence in the experiment as a human person, manipulating a certain number of things around the animal, should at one or other moment of the experiment, be put in question, taken into account. When one knows how a dog behaves vis-a-vis the one who is called or who is not called his master, one knows that the dimension of the Other counts, in any case, for a dog. But even if it were

not a dog, if it were a grasshopper or a leech, because of the fact that there is this collection of systems, the dimension of the Other is present. You will tell me: in a grasshopper or a leech, the organism undergoing the experiment, knows nothing about this dimension of the Other. I agree absolutely, and that is why my whole effort for a certain time was to demonstrate the extent of the level that in our case, as subjects, as we learn to manipulate, to determine this subject that we are, there is also a whole field where we know nothing about what constitutes us as field. And that the Selbstbewusstsein that I taught you to name, the subject who is presumed to know (le sujet suppose savoir), is a deceptive illusion. The Selbstbewusstsein considered as constitutive of a knowing subject is an illusion, (6) is a source of error. For the dimension of the subject supposedly transparent in his own act of knowing, only begins with the coming into play of a specified object which is the one that I am try to circumscribe in the mirror stage, namely, of the image of one's own body in so far as the subject in a jubilatory fashion has in effect the feeling of being before an object which makes him, the subject, transparent to himself.

The extension of this illusion, which in itself radically constitutes the illusion of consciousness, to every kind of knowledge is motivated by the fact that the object of knowledge will henceforth be constructed, modelled, on the image of this relationship to the specular image, and it is precisely why this object of knowledge is insufficient.

And if psychoanalysis did not exist, one would know it from the following: the fact is that there exist moments of the appearance of the object which throw us into a completely different dimension, a dimension which merits - since it is given by experience - to be detached as such as primal in experience, which is precisely the dimension of the strange, of something which can in no way allow itself to be grasped, as leaving before it the subject transparent to his knowledge.

Before this new thing, the subject literally vacillates and everything is put in question about the so-called primordial relation of the subject to every effect of knowledge.

This emergence of something in the field of the object, which poses its problem as being that of an irreducible structuring, as the emergence of an unknown as experienced, is not a question which is posed to analysts because since it is a given of experience it is all the same necessary to try to explain why children are afraid of the dark, and one sees at the same time that they are not always afraid of the dark, and then one does some psychology, the so-called experimenters engage precisely in theories about the effect of an inherited, ancestral, primordial reaction from a thinking - since it seems that it is always necessary to preserve the term thinking - from a thinking differently structured to logical, rational thinking. And people make constructions and invent things: this is how people start doing philosophy. Here we await those with whom we have on occasion to carry out the dialogue on the very terrain where

this dialogue has to be judged, namely whether we for our part can account for it in a less hypothetical fashion.

(7) This form that I am giving you, which is conceivable, consists in grasping that if in the constitution of an object which is the object correlative of a first mode of approach, the one which begins from the recognition of our own form, and if this knowledge, limited in itself, allows there to escape something of this primitive cathexis to our being which is given by the fact of existing as body, is it not saying something which is not only reasonable but testable to say that it is this remainder, it is this non-imagined residue of the body which comes by some detour - and here we are able to designate this detour - to manifest itself here at this place provided for the lack, to manifest itself in this fashion and in a fashion since it is not specular becomes henceforth unlocatable: this lack of certain reference points is effectively a dimension of anxiety.

We would not be in disagreement then with the way in which Kurt Goldstein would approach this phenomenon for example. When he speaks to us about anxiety, he speaks about it very pertinently. How is the whole phenomenology of lesional phenomena, where Goldstein minutely pursues this experience which interests us, to be articulated if not from the prior remark that the organism in all its relational effects functions as a totality. There is not a single one of our muscles which is not involved when we nod our head, that every reaction to a situation implies the totality of the organic response; and if we follow it, we see emerging two terms closely woven with one another, the term of catastrophic reaction, and in its phenomenon, within the field of this catastrophic reaction, the mapping out as such of phenomena of anxiety.

I would ask you to consult the very accessible texts - since they have been translated into French - of Goldstein's analyses in order to locate there at once the degree to which these formulations are close to our own and the degree of clarity they would draw by being more expressly based on them. Because at every instant, if you follow the text with this key that I am bringing you, you will see the difference there is between the disorder reaction by which the subject responds to his inoperancy, to the fact of being confronted with a situation which is unsurmountable as such, no doubt because of his deficit on this occasion. It is after all a way which is not foreign to what can happen to even a non-deficient subject before a situation, a situation of unsurmountable danger. In order for the Hilflosigkeit reaction of anxiety to be produced as such, two conditions are always necessary, - you can see it in the concrete cases mentioned -: 1) that the deficient effect should be sufficiently limited for the subject to circumscribe it in the test that he is undergoing, and .that by reason of this limit the lacuna appears as such in the objective field. It is this emergence of lack in a positive form which is the source of anxiety, provided that: condition 2), which must not be omitted here, that it is under the effect of a demand, of a test organised by the fact that the subject has before him Goldstein

or someone from his laboratory who subjects him to an organised test, that there is produced this field of lack and the question posed in this field, in these terms, that there is so little reason for omitting that when you know where and when to seek them, you will unfailingly find them, if there is need of it.

To jump to a completely different order, I would evoke here the most massive, unreconstituted, ancestral experience, rejected onto the obscurity of ancient times from which we are supposed to have escaped, a necessity which unites us with these ages which is still current and which very curiously we speak about only very rarely: it is that of the nightmare. One asks oneself why for some time, analysts interest themselves so little in the nightmare.

I introduce it here because it is going to be necessary all the same for us to remain on it this year for a certain time and I will tell you why. I will tell you why and where to find the material, because if there is already on this question an already established and very remarkable literature, to which you should refer, it is - however forgotten it may be on this point - it is namely Jones' book on the nightmare, a book of incomparable riches. I recall to you the fundamental phenomenology. I am not dreaming for a moment of eluding the principal dimension: the anxiety of the nightmare is experienced properly speaking as that of the jouissance of the Other. The correlative of the nightmare, is the incubus or the succubus, it is this being who weighs with his whole opaque weight of alien jouissance on your chest, who crushes you under his jouissance.

Well then, to introduce ourselves from this important angle into what the thematic of the nightmare will bring us, the first thing in any case which appears, which appears in the myth, but also in the phenomenology of the nightmare, of the nightmare as experienced, is that this being who weighs down by his jouissance is also a questioning being and even properly (9) speaking, one who manifests, deploys himself in this complete, developed dimension of the question as such which is called the riddle.

The sphinx, whose coming into play - do not forget - precedes the whole Oedipus drama, is a nightmare figure and a questioning figure at the same time. We will have to come back to it.

This question, giving the most primordial form of what I called the dimension of demand, the one - as you are going to see - that we usually call demand in the sense of a supposedly instinctual exigency is only then a reduced form of it. Here we are therefore brought back ourselves to a question which is articulated in the sense of interrogating once again, of coming back to the relationship of an experience which, in the usual sense of the term subject, can be called pre-subjective with the term of the question, of the question in its most well-shaped form, in the form of a signifier which proposes itself as opaque, which is the position of the riddle as such.

This brings us back to terms which I believe to be perfectly-articulated, I mean which enable you at every instant to put me back against my own wall, to account for definitions already proposed and to put them to the test of their usage. This signifier, as I told you at one turning point, is a trace, but an effaced trace. The signifier, as I told you at another turning point, is distinguished from the sign by the fact that the sign is what represents something for someone. But the signifier, as I told you, is what represents a subject for another signifier.

We are going to put this to the test again in the sense that concerning this object that is involved, namely our relationship, our anxiety-ridden relationship to some lost object - but which is surely not nevertheless lost for everyone - namely, as you see, as I will show you, where is it to be found again? Because of course, it is not enough to forget something for it not to continue to be there, only it is there where we no longer know how to recognise it. To find it again, it would be necessary to come back to the subject of the trace. For to give you terms designed to animate the interest of this research for you, I am going right away to give you two flashes on the subject of our most common experience.

(1) Does it not seem to you that there is an obvious correlation between what I am trying to outline for you and the phenomenology (10) of the hysterical symptom, the hysterical symptom, in the broadest sense? Let us not forget that there are not only little hysterias, there are also big ones: there are the anaesthetized, there are the paralyzed, there are the scotomized, there are narrowings of the field of vision. Anxiety only appears in hysteria exactly in the measure that these lacks are not seen.

(2) There is something which is not often glimpsed and even - I think I can say this - that you scarcely ever bring into play, it is something which explains a whole section of the behaviour of the obsessional.

I give you this key perhaps insufficiently explained since it is going to be necessary for me to bring you by a long detour - but I give you this term at the end of our path, among others, if only to interest you in this path - the obsessional, in his very particular way of dealing with the signifier, namely of putting it in doubt, of knowing how to polish it, to efface it, to triturate it, to break it into pieces, namely to behave with it like Lady Macbeth with this cursed spot of blood, the obsessional, taking a cul-de-sac no doubt, but one whose aim is not doubtful, operates, precisely in the sense of rediscovering under the signifier, the sign.

Ungeschehen machen: making the inscription of the story nul and void. It happened like that, but it is not sure. It is not sure because it is only signifier (du signifiant), that story is therefore a trick, and in this the obsessional is right; he has grasped something, he wants to go to the origin, to the previous

step, to that of the sign that I am now going to try to make you travel in the opposite sense. It is not for nothing that I started today from our laboratory animals. After all, animals do not exist only in laboratories, one could open the door and see what they for their part do with traces.

It is not only men who have the property of effacing their traces, of operating with traces. One sees animals effacing their traces. One sees even complex behaviours which consist in covering a certain number of traces, with dejection, for example. It is well known among cats.

One part of animal behaviour consists in structuring a certain field of its Umwelt, of its environment, by traces which punctuate it, which define its limits. It is what is called the constitution of the territory. The hippopotami do that with their dejections and also with the produce of certain glands which are, if I remember rightly, peri-anal in their case. The (11) deer rubs his horns against the bark of certain trees, this also has the import of a mapping out of traces. I am not going to develop here the infinite variety of what a developed zoology can teach you about this.

What is important to me, is what I have to tell you concerning what I mean about the effacing of traces. The animal, as I told you, effaces his traces and makes false traces. Does he for all that make signifiers? There is one thing that the animal does not do: he does not make false traces in order to make us believe that they are false. He does not make falsely false traces, which is a behaviour, that I would not say is essentially human, but precisely essentially signifying. This is where the limit is. You understand that I mean traces made so that one believes them to be false and which are nevertheless the traces of my true passing, and this is what I mean by saying that here a subject is presentified. When a trace has been made in order that one should take it to be a false trace, then we know that there is a speaking subject as such, and we know then that there is a subject as cause and the very notion of cause has no other support than that.

We try afterwards to extend it to the universe, but the original cause is the cause as such of a trace which presents itself as empty, which wants to be taken for a false trace. And what does that mean? That means indissolubly that the subject where he is born addresses himself to what? He addresses himself to what I would briefly call the most radical form of the rationality of the Other. For this behaviour has no other possible import than to rank itself at the locus of the Other in the chain of signifiers, of signifiers which have or have not the same origin, but which constitute the only possible term of reference for the trace which has become signifying.

So that you grasp here that at the origin, what nourishes the emergence of the signifier, is an aiming at what the Other, the real Other does not know. The "he did not know" is rooted in an "he must not know". The signifier no doubt reveals the subject,

but by effacing his trace.

First then there is an o, the object of the hunt, and an O in the interval of which the subject S appears, with the birth of the signifier, but as barred, as not-known (non-su) as such. (12) The whole subsequent mapping out of the subject reposes on the necessity of a reconquest of this original not-known.

Understand therefore here this something which already made appear to you the really radical relationship concerning the being to be reconquered of this subject and this grouping of o, of the object of the hunt, with this first appearance of the subject as not-known, which means unconscious, unbewusste justified by the philosophical tradition which confused the Bewusst of consciousness, with absolute knowledge and which cannot suffice for us, in so far as we know that this knowing and consciousness are not confused, but that Freud leaves open the question of where indeed the existence of this field defined as a field of consciousness comes from. And here after all I can claim that the mirror stage articulated as it is, contributes to this the beginnings of a solution. Because I well know how unsatisfied it can leave some spirits formed on Cartesian meditation. I think that this year we can take a further step which will make you grasp where the real origin, the original object of this system described as consciousness, is.

For we will not be satisfied to see the perspectives of consciousness being refuted until we know that it attaches itself to an isolatable object, to an object specified in the structure.

I indicated to you a little earlier the position of the neurotic in this dialectic. I do not intend to leave you in much suspense. To come back to it immediately, if you have been able to grasp the core of what is involved concerning the emergence of the signifier as such, this will enable us to understand immediately the slippery slope presented to us, concerning what happens in neurosis.

I mean that the demand of the neurotic, all the traps that analytic dialectic has gone into, come from the fact that there has been unrecognised in it the fundamental share of falseness that there is in this demand.

The existence of anxiety is linked to the fact that every demand, even the most archaic and the most primitive, always has something deceptive with respect to what preserves the place of desire, and this is what explains also the anxiety-ridden context of what gives a complete response to this false demand. This is what ensures that the mother who as I saw emerging, not so long ago, in the discourse of one of my patients, allowed absolutely no space between herself and her child up to a particular age, only gave to this demand a false response, a (13) really inexact response, since, if the demand is this something which is structured, in the way that I have told you, since the signifier is what it is, this demand is not to be

taken literally: what the infant demands from his mother by this demand, is something which for him is designed to structure this presence-absence relationship which the original fort-da game structures and is a first exercise of mastery over.

But the total filling of a certain void which should be preserved which has nothing to do with either the positive or negative content of the demand, this is where there arises the disturbance in which anxiety is manifested.

But in order to grasp it, to see clearly its consequences, it seems to me that our algebra brings us here a ready-made instrument. If the demand comes here improperly at the place of what is eluded, o the object, this explains to you, on condition that you make use of my algebra - what is an algebra if not something very simple designed to make us achieve a mechanical state in its handling, without you having to understand something very complicated, and it is much better like that: I have always been told: in mathematics, it is enough for the algebra to be correctly constructed - if I taught you to write the drive, \$ cut - we will come back to this cut and you have already begun to form a certain idea of it earlier; what it is a matter of cutting, is the elan of the hunter - \$ cut of D, of the demand, if this is how I taught you to write the drive, this explains to you first of all why it is among neurotics that drives were described. It is in the whole measure that the phantasy \$ 4 o presents itself in a privileged fashion, as in the neurotic, as |«D, in other words that it is a lure of the phantastical structure in the neurotic which allowed this first step called the drive to be made which Freud always and without any kind of wavering designated as Trieb, namely as something which has a history in German philosophical thought, which it is absolutely impossible to confuse with the term instinct.

As a result of this, even in the Standard Edition recently again and, if I remember rightly in the text of Inhibitions, symptoms and anxiety, I find translated by "instinctual need", something which in the German text is called Bedürfnis. Why not translate (14) simply, if you wish, "Bedürfnis" by "need", which is a good translation from the German to the English? Why add this "instinctual" which is absolutely not in the text and which is enough to falsify the whole meaning of the sentence?

All of which immediately allows it to be grasped that a drive has nothing to do with an instinct - I have no objection to make to the definition of something that can be called instinct and even as it is called in the usual fashion, why not for example, describe in this way the needs that living beings have to feed themselves, for example.

Well then, yes, since it is the oral drive that is involved, does it not seem to you that the term of erotogeneity applied to what is called the oral drive is something which brings us right away to the problem: why is it only the mouth that is involved? And why not also the gastric secretions, because a little earlier, we were talking about Pavlov's dogs? And even why more

especially if we look closely at it, up to a certain age, only the lips and, when that time has passed, what Homer called the enclosure of the teeth?

Do we not find there immediately, from the first properly speaking analytic approach to instinct, this line of breaking which I speak to you about as essential to this dialectic established by this reference to the other in the mirror the reference to which I thought I had brought you earlier - I did not find it in my papers - that I will give you the next time, in Hegel, in the Phenomenology of the spirit, where it is formally said that language is work, it is in this way that the subject makes his inside pass to the outside. And the sentence even is such that it is quite clear that this inside-out, as they say in English is really the metaphor of the glove turned inside out.

But if I gave to this reference the idea of a loss, it is in as much as something in it does not undergo this inversion, that at every stage a residue remains which is not invertible, nor signifiable in this articulated register. And we will not be astonished that these forms of the object appear to us under the form that is called partial; that has struck us enough for us to annotate it as such under the sectioned form, in which we are led to make intervene an object for example correlative to this oral drive.

This maternal nipple, the first phenomenology of which cannot fail to be admitted as that of a cut, riddled, breast, I mean something which is presented as having an artificial character. This indeed is what allows it to be replaced by any other kind (15) of soother which functions exactly in the same way in the economy of the oral drive.

If one wishes to make biological references - the references to need, of course are essential, it is not a matter of refusing them - but it is to see that the completely primitive structural difference introduces there the fact of ruptures, of cuts, introduces there immediately the signifying dialectic. Is there something here which is impenetrable to a conception that I would call everything that is most natural? The dimension of the signifier, what is it, if not, if you wish, an animal who in the hunt for his object is caught up in something such that the pursuit of this object must lead him onto another field of the trace where this pursuit itself as such no longer takes on anything but an introductory value.

The phantasy, the | with respect to o, here takes on the signifying value of the entry of the subject into this something which is going to lead him to this indefinite chain of signifiers which are called destiny..

One can escape it indefinitely, namely that what it is going to be a matter of rediscovering, is precisely the start: how it got into this business of the signifier.

Now it is all the same clear that it is well worth the trouble to recognise how the first objects, those which were located in the structure of the drive, namely the one which I already named above, this cut breast, and then later, the demand to the mother being inverted into a demand of the mother, for this object, which one cannot otherwise see why it should be privileged, this object which is called the turd, namely something which also has a relationship with a zone which is called erogenous and regarding which it is all the same necessary to see that here also it is in so far as separated by a limit from the whole functional system that it is close to, and which is infinitely more vast among the excretory functions - why the anus, if it is not in its determining function as a sphincter, of something which contributes to the cutting of an object, and the object that is involved is the turd with everything that it can come to represent, not simply, as is said, the gift, but the identity with this object whose nature we are seeking - and this is what gives it its value, its accent.

And what am I saying against this, if not precisely to justify the eventual function which is given to it under the rubric of ((16) object relations in the evolution - I do not mean yesterday, but the day before yesterday - of analytic theory, except that it is altogether to falsify it to see in it a sort of model of the analysand's world in which a process of maturation would allow the progressive restoration of a reaction presumed to be total, authentic, while all that is involved is a scrap designating the only thing that is important, namely the place, the place of a void where there would come - as I will show you - to be situated, other much more interesting objects which you know moreover already, but that you do not know how to place.

For today only to preserve the place of this void, because moreover something in our project will not fail to evoke the existential and even the existentialist theory of anxiety, you can be sure that it is not by chance that one of those whom one can consider as one of the fathers, at least in the modern era, of the existential perspective, this Pascal whom we do not know too well why he fascinates us because if we believe the theoreticians of science he got everything wrong - infinitesimal calculus that he was, it appears, within an ace of discovering, I think rather that he did not give a damn about it, because there is something which interested him and this is why Pascal still touches us, even those among us who are absolute unbelievers - it is that Pascal, like the good Jansenist that he was, was interested in desire. And that is why, I tell you this in confidence, he carried out the experiments of Puy de Dome on the vacuum. Whether nature does or does not abhor a vacuum, was capital for him, because that signified the abhorrence of all the scholars of his time for desire. This vacuum is of absolutely no theoretical interest any longer. It has almost no meaning for us any longer. We know that in a vacuum, we know there can still be produced knots, fullnesses (des pleins), packets of waves, and anything you could wish. And for Pascal precisely, because, if not nature, the whole of thought up to

then had a horror of the fact that there could be a vacuum anywhere, this is what is proposed to our attention, and to know whether, we also for our part do not yield from time to time to this horror.

What I am evoking for you here then is not metaphysics. I allowed myself to employ a term to which contemporary events have given a certain prominence for some years, I will speak rather of brain-washing.

What I intend to do is to teach you, by means of a method, to recognise, to recognise in the right place what presents itself in your experience; and of course the efficacy of what I am claiming to do can only be tested by experience.

Seminar 6: Wednesday 19 December 1962

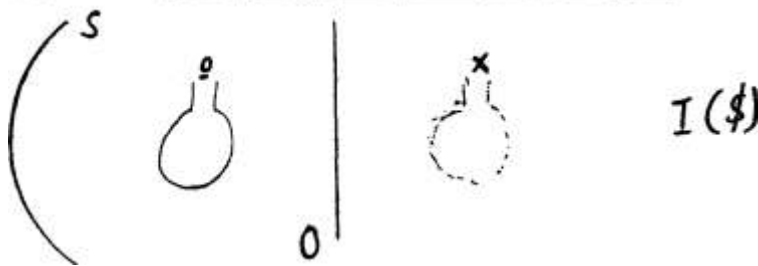

And if sometimes people have objected to the presence at my teaching of certain people whom I have in analysis, after all the legitimacy of the co-existence of two relationships to me, the one in which I am heard and the one in which one makes oneself heard by me, can only be judged from within and in the measure that what I am teaching you here can effectively facilitate for each one - I mean in any case for someone who is working with me - an access to the recognition of his own path.

In this connection of course there is something, a limit, where external control stops, but undoubtedly it is not a bad sign, if it can be seen, that those who participate from these two positions will at least learn from them to read better.

Brain-washing, I have said, is indeed for me to submit myself to this control of recognising in the remarks of those that I analyse something different to what there is in the books. Inversely, for them, it is that to know how to recognise in passing in the books what is effectively in the books. And in this connection, I can only congratulate myself for example on a little sign, like this recent one, which came to me from the mouth of someone precisely whom I have in analysis, that in passing there did not escape him the import of a trait like this one that can be caught in passing in a book whose French translation has appeared recently - and how late it is - in a work by Ferenczi, namely this book whose original title is: Versuch einer Genitaltheorie, "Research" - very precisely - "into a theory of genitality", and not simply "About the origins of

(2) sexual life", as they have drowned it here, a book which undoubtedly cannot but be disturbing because of a certain aspect which I already highlighted long ago for those who know how to listen as having at times its share at times, but which, bringing with it all the same this enormous experience, allows there to be posited in its detours several traits which are precious for us, including the following to which I am sure the author himself does not give all the importance it merits precisely in his plan, in his research, by arriving at a too harmonious, a too all-englobing notion of what constitutes its object, namely, the genital perspective, realisation.

In passing, here is how he expresses himself: "The development of genital sexuality, cursorily described above in the male", he says - it is in effect what is involved in the male man, the male - "undergoes in the female", what is translated as, "a rather sudden interruption", an altogether incorrect translation because what is involved in German is "eine zimmlich unvermittelte Unterbrechung", an interruption, that means that it is most often unmediated, that it is not a part of what Ferenczi describes as amphimixis, which is only when all is said and done, one of the natural forms of what we call "thesis, antithesis, synthesis", of what we call dialectical progress, as I might put it. This, no doubt, is not the term which is valorised in Ferenczi's mind, but what animates effectively his whole construction, is indeed what he notes, it is that unvermittelte, namely in a lateral position with respect to this process - and let us not forget what it is a matter of finding - of genital synthesis and harmony, is therefore to be properly translated here by "rather as an impasse", outside the progress of mediation.

This interruption, he says, "is characterized above all else", and here he only accentuates what Freud tells us - "by the displacement of erogeneity from the clitoris (the female penis) to the cavity of the vagina. Psychoanalytic experience compels the assumption, however, that not only the vagina but, in the manner of hysteria, other parts of the body as well are genitalized, in particular the nipple and the surrounding area."

As you know, there are many other zones again in hysteria. Besides moreover the translation here, because it does not effectively follow the precious aspect of what we are brought here as material, a translation that is in a way, there (3) is simply, not at all "en témoigne également", but "nach Art der Hystérie" in German.

What does that mean? What does that mean, for someone who has learned - whether here or elsewhere - to understand, if not that the coming into operation of the vagina as such in the genital relationship, is a mechanism that is strictly equivalent to any other hysterical mechanism? And here why should we be astonished? Why should we be astonished at this from the moment that through our schema of the place of the empty locus in the function of desire you have quite ready to be recognised something about which the least that can be said is that, for

you, it could at least situate this paradox, this paradox which is defined as follows: the fact is that the locus, the home of jouissance is found normally, since it is naturally placed precisely in an organ which you know in the most certain fashion, through experience as well as by an anatomical-physiological investigations, to be insensitive in the sense that it could not even become aware of sensation because it is not innervated, that the locus, that the final locus of jouissance, of genital jouissance is a place - after all, it is not a mystery - onto which one can pour floods of boiling water, and at a temperature that could not be tolerated by any other mucus membrane, without provoking real, immediate sensory reactions.

What does that mean, if not that we have every reason, before entering into the diachronic myth of a supposed maturation, to map out the correlations which would make of the no doubt necessary point of arrival, of completion, of accomplishment of the sexual function in the genital function, something other than a process of maturation, than a locus of convergence, of synthesis, of everything that presented itself up to then in terms of partial tendencies and to recognise, not alone the necessity of this empty place in a functional point of desire, but to see that even if it is there that nature itself, that physiology is going to find its most favourable functional point, we thus find ourselves in a clearer position, at once liberated from this weight of paradox which is going to make us imagine so many mythical constructions around the supposed vaginal jouissance, and not at all of course that something cannot be indicated beyond - and it is, if you remember, those who attended our Amsterdam Congress, what they may remember I indicated at the beginning of the Congress, something which for want of an (4) apparatus, for want of this structural register whose articulations I am trying to give you here, could not even, in the course of a Congress at which many worthy things were said, be effectively articulated and mapped out as such, and nevertheless how precious it is for us to know, since moreover all the paradoxes concerning the place to be given to hysteria in what could be called the scale of neuroses, this ambiguity in particular which brings it about that because of these obvious analogies whose essential element, major element I am highlighting here with the hysterical mechanism, we are called to put it on a diachronic scale as the most advanced neurosis because it is the closest to genital completion, that it is necessary for us in the light of this diachronic conception to put at the end of infantile maturation, and that by the reversal that clinical experience shows us on the contrary, we must, in the neurotic scale, consider on the contrary as the most primary, the one upon which specifically, for example, the constructions of obsessional neurosis are constructed, that the relations in a word between hysteria and psychosis itself, with schizophrenia are obvious.

The only thing that can allow us also not to be eternally, as the need arises - and observers bring us the points of view that we have to tackle on hysteria - putting it either at the end, or at the beginning, of supposedly evolutionary phases, is first and

foremost to refer it to what predominates, namely the structure, the synchronic structure of desire (See schema, page 1). It is to isolate, in the constitutive structure of desire as such, which means that I designate this place, the place of the blank, the place of the void, as still playing an essential function; and the fact that this function should be highlighted in a major way, in the completed, terminal structure of the genital relationship, is at once the confirmation of the well-foundedness of our method and also the beginning of a clearer vision, cleared of , of what we have to map out concerning properly genital phenomena.

There is no doubt an obstacle, an objection to us seeing it directly because in order to reach it we must go by a rather complicated path. This roundabout path is anxiety and that is why we are dealing with it this year.

The point that we are at at this moment at which there comes to completion with the year a first phase of our discourse, consists (5) therefore in you assuring yourselves that there is a structure of anxiety; and the important point, the core of the fashion in which in these first talks I announced, put forward, tackled for you, is sufficiently in this image, I mean, in what it contributes in terms of a framework which is to be taken entirely in its specified character. I would even say up to a certain point that it still does not show adequately, in this tachygraphic form, in which - I have been repeating it for you on the blackboard since the beginning of my discourse - it is necessary to insist on the fact that this stroke is something that you see in cross-section and is a mirror. A mirror does not stretch out to infinity, a mirror has limits, and what reminds you of this is that, if you refer to the article from which this schema is taken, I take into account the limits of the mirror; one can see something in this mirror from a point situated, as one might say, somewhere in the space of the mirror, from which it is not perceptible by the subject.

In other words, I myself do not necessarily see my eye in the mirror, even if the mirror helps me to see something that I would not see otherwise. What I mean by that, is that the first thing to be advanced concerning the structure of anxiety, is something that you always forget in the observations where it reveals itself: fascinated by the content of the mirror, you forget its limits and the fact that anxiety is framed.

Those who heard my intervention at the Journées Provinciales on phantasy, the text of which intervention I am still waiting for after two months and a week, may recall that I used as a metaphor a painting which is placed in a window frame, an absurd technique no doubt, if it is a matter of better seeing what is on the painting, but as I also explained to you, it is not exactly this that is involved, it is, whatever may be the charm of what is painted on the canvas, not to see what can be seen through the window.

What the inaugural dream in the history of analysis shows us in the dream of the Wolfman, whose privilege, as happens

incidentally and in an unambiguous fashion, is that it is the apparition in the dream of a pure schematic form of the phantasy, it is because the repetitive dream of the Wolfman is the pure phantasy unveiled in its structure, that it takes on its importance, and that Freud chooses it to make, in this observation which only has this unexhausted, inexhaustible (6) character for us because it involves essentially, from beginning to end, the relationship of the phantasy to the real. What do we see in this dream? The sudden opening - and the two terms are indicated - of a window. The phantasy is seen beyond a pane and through a window which opens, the phantasy is framed; and you will recognise in what you see beyond - if you know of course how to perceive it - you will recognise in its most diverse forms the same structure that you see here in the mirror of my schema. There are always the two bars of a more or less developed support and of something which is supported, there are the wolves on the branches of the tree; there is on some drawing or other of a schizophrenic - I have only to open any collection to gather them up as I might say by the shovel-full - also on occasion some tree with at the end for example - to take my first example in the paper given by Bobo(?) at the last Antwerp Congress on the phenomenon of expression - with what at the end of its branches? That which for a schizophrenic fills the role that the wolves play in the case of the borderline that the Wolfman is. Here, a signifier, it is beyond the branches of the tree that the schizophrenic in question writes the formula of his secret: "Io sono sempre vista", namely something that she had never been able to say up to then "I am always seen". Here again I must pause in order to make you see that in Italian as in French, vista has an ambiguous meaning, it is not only a past participle, it is also sight with its two meanings subjective and objective, the function of sight and the fact of being seen, as one says the sight of a landscape, the one which is taken there as an object on a postcard. I will of course come back on all of that.

What I simply want to stress here today, is that the horrible, the suspicious, the uncanny, everything by which we translate, as best we can in French, this masterful unheimlich, presents itself through skylights, that it is as framed that there is situated for us the field of anxiety. Thus you rediscover that by which I introduced the discussion for you, namely the relationship between the stage and the world.

"Suddenly", "all of a sudden", you will always find this term, at the moment that the phenomenon of the unheimlich makes its entry! The stage which proposes itself in its own dimension, beyond no doubt we know that what ought to be referred to it is what cannot be said in the world. It is what we always expect when the curtain rises, it is this quickly extinguished brief moment of anxiety, but which is never lacking to the dimension which ensures that we are doing more than coming to settle our backsides into a more or less expensive seat, which is the moment of the three knocks, which is the moment the curtain opens. And without this, this quickly elided introductory moment of anxiety, nothing could even take on the value of what is going to be

determined as tragic or as comic, that which cannot be, here again, not every tongue provides you with the same resources, it is not a konnen that is involved. Of course many things can be said, from a material point of view. It is a matter of a being able, durfen, which badly translates what is permitted or not permitted, since durfen refers to a more original dimension. It is even because Man darf nicht, that it cannot be done, that Man kan, that after all one is going to be able, and that here there comes into play the forcing, the dimension of relaxation, that properly speaking constitutes the dramatic action.

We could not spend too much time on the nuances of this framing of anxiety. Are you going to say that I am appealing to it in the sense of bringing it back to expectation, to preparation, to a state of alert, to a response which is already one of defence to what is going to happen. That yes! It is the Erwartung, it is the constitution of the hostile as such, it is the first recourse beyond Hilflosigkeit♦

But anxiety is different. If, in effect, expectation can serve among other means to frame it, in a word, there is no need for this expectation: the frame is always there! Anxiety is different. Anxiety is when there appears in this frame something which is already there much closer to home: Heim, the guest (l'h5te), you will say, and in a certain sense, of course, this unknown guest who appears in an unexpected fashion has a good deal to do with what is met with in the Unheimlich, but it is not enough to designate him in this way. For, as the term indicates to you very well as it happens in French, this guest, in the ordinary sense of the word, is already someone who has been well worked over in terms of expectation.

This guest is already what had become hostile, had passed into the hostility by which I began this discourse about expectation. This guest, in the ordinary sense, is not the heimlich, it is not the person who lives in the house, it is someone hostile who has been softened, pacified, accepted. That which belongs to Heim, that which belongs to Geheimnis, has never passed through these detours when all is said and done, has never passed through these (8) networks, through these sieves, through these sieves of recognition: it has remained unheimlich, less uninhabitable than inhabitant (moins inhabituable qu'inhabitant), less inhabitual than uninhabited (moins inhabituel qu'inhabite).

It is this emergence of the heimlich in the frame that constitutes the phenomenon of anxiety. And this is why it is wrong to say that anxiety is without an object. Anxiety has a completely different sort of object to any apprehension that has been prepared, structured, structured by what? By the grill of the cut, of the furrow, of the unary trait, of the "that's it" which always in operating as one might say closes the lips - I am saying the lip or the lips - of this' cut which becomes the sealed letter on the subject in order, as I explained to you the last time, to send him off under a sealed cover to different traces.

The signifiers make of the world a network of traces, in which

the passage from one cycle to another is henceforth possible. What does that mean? What I told you the last time: the signifier generates a world, the world of the speaking subject whose essential characteristic is that it is possible to make a mistake about it.

Anxiety is this very cut, without which the presence of the signifier, its functioning, its entry, its furrow in the real is unthinkable. It is this cut which is opened up and which allows there to appear something that you will understand better when I say the unexpected, the visit, the piece of news, what is expressed so well by the term presentiment which is not simply to be understood as the presentiment of something, but also the "pre" of Reeling, that which is before the birth of a feeling.

All the switching points are possible starting from something which is anxiety, which is, when all is said and done what we expected and which is the true substance of anxiety, the "what does not deceive", what is beyond doubting, for do not allow yourself to be taken in by appearances: it is not because, of course, the link between anxiety and doubt and hesitation, and what is called the ambivalent game of the obsessional, may appear clinically obvious to you, that it is the same thing.

Anxiety is not doubt; anxiety is the cause of doubt. I am saying the cause of doubt, it is not the first time, and it will not be the last, that I will have to come back here on the fact that if there is maintained, after so many centuries of critical understanding, the function of causality, it is indeed because it (9) is elsewhere than where it is refuted, and that if there is a dimension in which we should seek the true function, the true weight, the meaning of the maintenance of the function of causality, it is in this direction of the beginning of anxiety. Doubt therefore as I told you, is only there to combat anxiety and precisely all the effort that doubt expends, is against lures. It is in the measure that what it is a matter of avoiding is the dimension of appalling certainty that is in anxiety.

I think that you will stop me here to tell me, or to remind me, of what I put forward more than once in aphoristic forms, that all human activity expands into certainty or again that it generates certainty or in a general fashion that the reference to certainty is essentially action. Well yes, of course, and it is precisely this that allows me to introduce now the essential relation between anxiety and action as such, it is precisely perhaps from anxiety that action borrows its certainty.

To act is to tear its certainty from anxiety. To act, is to operate a transfer of anxiety. And if I allow myself to advance here a little quickly this discourse at the end of the trimester, it is to fill in or to almost fill in the blanks that I left you with in the table of my first seminar. I think that you remember it the one which is organised as follows:

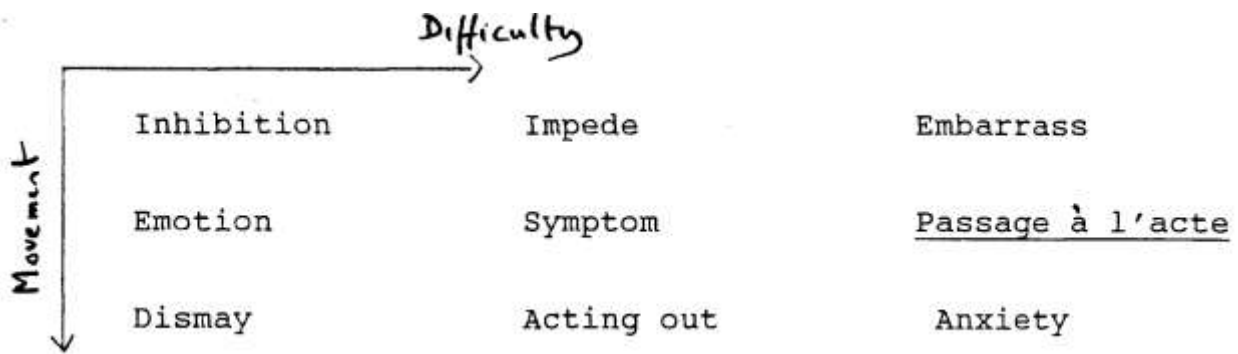

Inhibition, symptom, anxiety, impede, which I completed with embarrass, with emotion and here dismay. I said to you: what is here? Two things: the passage a l'acte and acting-out. I said almost to be complete, because I have not the time to tell you why, the passage a l'acte in this place and acting out at a different one, but I will all the same make you advance along the path by pointing out to you, in the closest relationship with our remarks this morning, the opposition that was already implied and even expressed in my first introduction of these terms, and whose position I am now going to underline, namely between the dimension of too much which is in embarrassment and the dimension of the too little in what I told you, by means of an etymological commentary which you remember I think - at least those who were (10) there - I underlined about the sense of dismay.

Dismay, as I told you, is essentially the evocation of a power which is lacking, esmayer, the experience of what you are lacking in need. It is in the reference to these two terms whose link is essential in our subject; for this link underlines the ambiguity: if there is too much, what we have to deal with then is not lacking to us; if it is lacking to us, why say that elsewhere it embarrasses us, let us be on our guard here not to yield to the most flattering of illusions.

In attacking anxiety here ourselves, what are we trying to do, what do all those who have spoken of it 'scientifically' want? Good Lord, it was that it was pure need, what was required of me to posit at the beginning as necessary for the constitution of a world, it is here that this reveals itself not to be useless, and that you have control of it. This is better seen precisely because it is anxiety that is involved. And what is seen is what? And to want to speak about it in a properly scientific way is to show that it is what? An immense deception. It is not realised that the whole domain which our discourse has conquered always ends up showing that it is an immense deception.

To master the phenomenon by thought, is always to show how one can remake it in a falsified way, it is to be able to reproduce it, namely to be able to make a signifier of it. A signifier of what? In reproducing it the subject can falsify the book of accounts, which should not astonish us if it is true, as I teach you, that the signifier is the trace of the subject in the world's course. Only, if we believe we are able to continue this game with anxiety, well then, we are sure of missing out, because

precisely I stated right at the beginning that anxiety is concerned with what escapes this game. Therefore this is what we must be on guard against at the moment of grasping what is meant by this relationship of embarrassment to too much signifier, of lack to too little signifier. I am going to illustrate this relationship if you have not done so already: if there were no analysis, of course, I could not speak about it; but analysis encountered it at the first corner. The phallus for example, little Hans, just as much of a logician as Aristotle, poses the equation: all animate beings have a phallus. I am presupposing of course that I am addressing myself to people who have followed my commentary on the analysis of little Hans, who will remember here in this connection, I think, what I was careful to (11) accentuate last year concerning what is called the universal affirmative proposition. I told you the meaning of what I wanted to produce for you by this, namely that the affirmation which is described as universal, positive universal, only has meaning from the definition of the real, starting from the impossible. It is impossible for an animate being not to have a phallus, something that, as you see, poses logic in this essentially precarious function of condemning the real, of eternally stumbling into the impossible. And we have no other means of apprehending it, we advance from stumble to stumble. Example: there are living beings, Mummy for example, who do not have a phallus, so there must be no living beings, hence anxiety.

And the following step is to be taken. It is certain that the easiest thing is to say that even those who do not have one, have one. This indeed is why it is the one that we hold onto in general. It is that the living beings which do not have a phallus have one despite and against everything. It is because they have a phallus that we psychologists will call unreal - this will simply be the signifying phallus - that they are living beings.

Thus, from one stumble to another, there progresses I do not dare to say knowledge, but undoubtedly understanding. I cannot resist the pleasure in passing of sharing with you the discovery that chance, a lucky chance, what is called chance but which is scarcely that at all, a lucky discovery that I made for you no later than last week-end, in a dictionary of slang. God knows, I have taken enough time to come to it, but the English tongue is really a lovely tongue. Is there anyone here then who knows that since the fifteenth century, English slang has found this marvel of replacing on occasions "I understand you perfectly", for example, by "I understumble", namely - I am writing it out, since the phonetising has allowed you perhaps to miss the nuance - what I have just explained to you, not what is meant by understand: I understand you, but something untranslatable into French since the whole value of this slang word is the famous stumble which means precisely what I am in the process of explaining to you: the trebuchement. I understand you, ' that reminds me that one way or another, is always to go further along the path of misunderstanding.

Moreover, if the stuff of experience was composed, as classical

psychology teaches us, of the real and the unreal - and why not - how can one not recall in this connection what this indicates to (12) us in terms of having to take advantage of what is properly the Freudian conquest, and which is specifically the following: it is that if man is tormented by the unreal in the real, it would be altogether vain to hope to rid oneself of it for the reason, which is what in the Freudian conquest is quite precisely disturbing, that in the unreal, it is the real which torments him. His concern, Sorge, the philosopher Martin Heidegger tells us. Of course! This is a great advance for us.

Is this the final term, that before busying oneself, before speaking, before getting down to work, concern is presupposed? What does that mean? And do we not see that here we are already at the level of an art of concern: man is obviously a great producer of something which in so far as it regards him is called concern. But in that case, I prefer to learn it in a holy book, which is at the same time the most profanatory book which exists, called Ecclesiastes. I think I will refer to it in the future. This Ecclesiastes which is as you know the Greek translation in the septuagint of the term goheleth, a unique term, employed on this occasion, which comes from qahal, congregation, goheleth, being at once the abstract and feminine form of it, being properly speaking the congregating virtue, the rallier, the ecclesia, if you wish, rather than Ecclesiastes.

And what does it teach us, this book which I described as a sacred and most profane book. Here the philosopher does not fail to stumble, in reading it, on some Epicurean echo or other, as I have read! To talk of Epicurean in connection with Ecclesiastes! I know that Epicurus has long ceased to calm us, as was, as you know his intention. But to say that Ecclesiastes had for a single moment a chance of producing the same effect on us, can only mean that one has never even opened it!

"God commands me to enjoy (de jouir)" - this is textually in the Bible - it is all the same the word of God. And even if it is not the word of God for you, I think that you have already noticed the total difference there is between the God of the Jews and the God of Plato. Even if Christian history thought itself obliged, in connection with the God of the Jews, to find with the God of Plato its little psychotic evasion, it is, all the same, time to remember the difference there is between the universal mover God of Aristotle, the sovereign good God, a delusional conception of Plato, and the God of the Jews, namely a God with whom one speaks, a God who demands something of you and who in (13) Ecclesiastes gives you the order "enjoy (jouis)". That is really something! Because to enjoy when ordered to do so, is all the same something in which everyone senses that if there is a source, an origin of anxiety, it ought all the same to be found somewhere there. To this order "Jouis!", I can only answer one thing, which is: "J'ouïs (I hear)". 'Of course, but naturally I do not enjoy so easily for all that.

Such is the relief, the originality, the dimension, the order of presence, in which there is activated for us the God who speaks,

the one who tells us expressly that he is what he is. In order to advance while it is there within my reach, into the field of his demands, and because you are going to see that it is very close to our subject, I would introduce - this is the moment - something which you may well imagine I did not notice today or yesterday, namely that, among these demands of God to his elected, privileged people, there are some quite precise ones regarding which it seems that this God did not need the prescience of my seminar to carefully specify the terms. There is one of them called circumcision.

He orders us to enjoy, and what is more he goes into how it should be done. He specifies the demand, he separates out the object. This is why, I think, for you as for me, there could not fail to appear for a long time, the extraordinary entanglements, the confusion of the analogical evocation that there is in the supposed reference of circumcision to castration. Of course this has a relationship with the object of anxiety.

But to say that circumcision is the cause of it, or in any fashion whatsoever, the representative, the analogue of what we call castration and its complex, is a flagrant error. It does not get you out of the symptom precisely, namely of that which in the case of some subject or other who has been circumcised, may establish itself, in terms of confusion concerning its brand with what is involved eventually in neurosis regarding the complex of castration.

Because after all, there is nothing less castrating than circumcision. When it is clear-cut, when it is well done, undoubtedly we cannot deny that the result is rather elegant. I assure you that alongside all these sexual organs, I mean the male ones, of greater Greece than the antique dealers, on the pretext that I am an analyst, bring me by the cartload and which my secretary puts into the already overcrowded courtyard, alongside all these sexual organs, in which I must say that by an accentuation which I do not dare to qualify as aesthetic the phimosis is always accentuated in a particularly disgusting (14) fashion; there is all the same in the practice of circumcision something healthy from the aesthetic point of view. And moreover those who continue to repeat on this point the confusions which are all over psychoanalytic writings, all the same most of them have long ago grasped that there was something from the functional point of view which is just as essential as reducing, at least in part in a signifying fashion, the ambiguity that is described as the bisexual type. "Je suis la plaie et le couteau", Baudelaire says somewhere. Well then, why consider it to be the normal function to be at once the dart and the sheath? There is obviously in this ritual attention of circumcision a reduction of bisexuality which cannot but obviously generate something healthy as regard the division of roles.

These remarks, as you can well sense, are not by the way, they open up precisely the question which situates beyond, something which already from this explanation can no longer appear as a sort of capricious ritual, but something which conforms to what

in the demand I teach you to consider as the circumscribing of the object, as the function of the cut - it must be said - of this delimited zone here: God demands an offering, and very precisely to separate out the object after having circumscribed it; that whether after that the sources as well as the experience of those who are grouped together, recognise one another by this traditional sign, that if their experience does not for all that lead to a lowering - perhaps far from it - of the relation to anxiety, it is starting from there that the question begins.

One of those who are evoked here - and it is really not designating anybody in my audience - called me one day in a private note the last of the cabalistic Christians. You can be reassured, if some investigation or other involving properly speaking the calculus of signifiers may be something on which I delay from time to time, it will never make me mistake as I may say my illusions for the lantern of knowledge; or indeed rather, if this lantern turns out to be a blind lantern, to recognise my illusion in it, but more directly than Freud because, coming after him, I question his God: "Che vuoi?", "What do you want of me?", in other words: "What is the relationship of desire to the law?" A question always elided by the philosophical tradition, but to which Freud answered - and you live on it, even if like (15) everybody else you have not realised it. The reply: it is the same thing as what I am teaching you, what I am teaching you leads you to, and which is already there in the text, masked under the myth of Oedipus, it is that desire and the law, which appear to be opposed in a relationship of antithesis, are only one and the same barrier to bar our access to the thing. Nolens, volens: desiring, I commit myself to the path of the law. That is why Freud relates the origin of the law to the opaque ungraspable desire of the father. But what this discovery and all analytic enquiry leads you to, is not to lose sight of the truth there is behind this lure.

Whether my objects are normatived or not, as long as I desire, I know nothing of what I desire. And then from time to time an object appears among all the others, which I really do not know why it is there. On the one hand, there is the one which I have learned covers my anxiety, the object of the phobia - and I do not deny that I had to have it explained to me; up to then I did not know what I was thinking about, except to say that you have one, you have or you have not one - on the other hand, there is the one, as regards which I cannot really justify why it should be the one I desire, and I, who do not detest girls, why should I love a little slipper still more. On the one hand there is the wolf, on the other the shepherdess. This is where I will leave you at the end of these first talks about anxiety, there is something else to be understood about the anxiety-provoking order of God, there is Diana's hunt which, at a time that I chose, that of Freud's centenary, was, I told you, the path of Freud's quest, there is something to which I invite 'you for the coming trimester regarding anxiety, there is the death of the wolf.

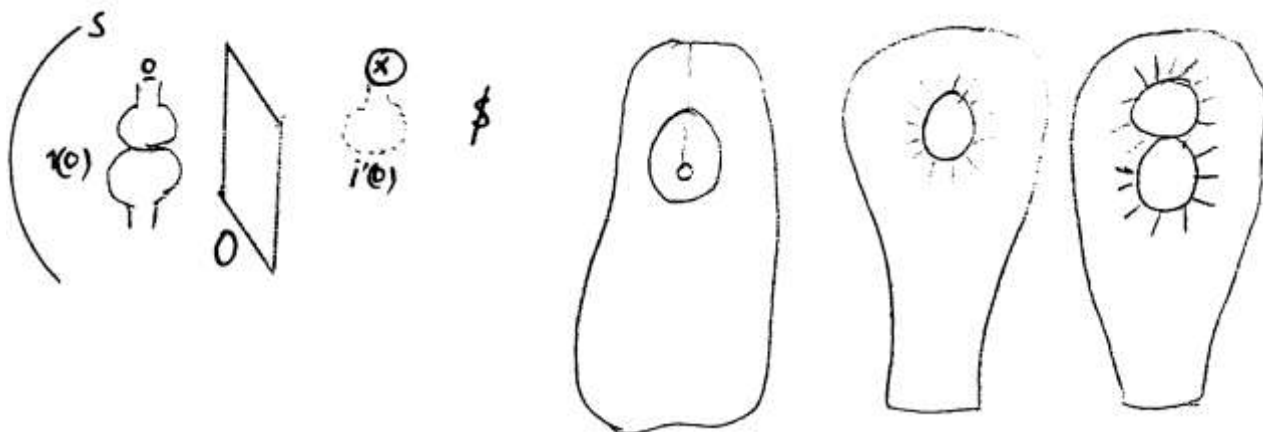
Seminar 7: Wednesday 9 January 1963

In the thirty-second introductory lecture to psychoanalysis, namely in the series of New Introductory Lectures on Psychoanalysis which has been translated into French, Freud specifies that it is a matter of introducing something which has not, he says, in any way a purely speculative character, but it has been translated for us in the unintelligible French which you can form your own opinion of: "Mais il ne peut vraiment être question que de conceptions. En effet, il s'agit de trouver les idées abstraites, justes qui appliquées a la matière brute de l'observation y apporteront ordre et clarté". There is no full stop in German where I have shown it, and there is no enigma in the sentence: "It is a matter", Freud tells us, "Sondern es handelt sich wirklich", not truly but really, "of conceptions" (comma), namely I mean by that Vorstellungen, correct abstract representations, it is a matter of einzufahren them, of bringing them, of bringing to light, these conceptions whose application to the rohe Stoff, the raw material of observation, Beobachtung, will permit us to make emerge from them, to give birth from them to order and transparency.

It is obviously always distressing to entrust something as precious as the translation of Freud to ladies-in-waiting.

This effort, this programme, the one that we have been trying our best at here for some years, and it is because of this that today we find that we have, in short, specified on our path about anxiety, the status of something which I would designate right away by the letter o which you see here enthroned above the outline, the outline of the vase which symbolizes for us the narcissistic container of the libido, in so far as through the mediation of this mirror of the Other it can be related to its

own image $i'(o)$ and that between the two there can operate this communicating oscillation that Freud designates as the reversibility between the libido of one's own body and that of the object.

From this economic oscillation, this reversible libido from $i(o)$ to $i'(o)$, there is something which we would not say escapes, but which intervenes in the form of an incidence whose style of disturbance is precisely the one that we are studying this year. The most striking manifestation, the signal of the intervention of this object o , is anxiety.

This does not mean that this object o is only the reverse of anxiety, that it only intervenes, that it only functions in correlation with anxiety. Anxiety, Freud taught us, plays the function of a signal with respect to something. I am saying: it is a signal related to what is happening about the relationship of a subject, of a subject who moreover cannot enter into this relationship except in the vacillation of a certain fading, the one which the notation of the subject by an $\$$ designates, the relationship of this subject, at this vacillating moment, with (3) this object in all its generality.

Anxiety is the signal of certain moments of this relationship. This is what we are going to strive to show you more about today. It is clear that this supposes a further step in the situation of specifying what we mean by this object o . I mean, we designate this object precisely by o . I point out that this algebraic notation has its function, it is like a thread designed to allow us to recognise its identity under the different incidences in which it appears to us. Its notation is algebraic, o , precisely to respond to this goal of pure mapping out of identity, it having already been posited by us that the mapping out by a word, by a signifier, is always and can only be a metaphor, namely leaving in a way, outside the signification induced by its introduction, the function of the signifier itself. The term good though it generates the signification of good, is not good by itself and far from it, for it generates evil at the same time.

In the same way to designate the little o by the term object is, as you see, a metaphorical usage, since it is borrowed precisely from this subject-object relationship from which the term object is constituted, which no doubt is suitable for designating the general function of objectivity; and this object, of which we have to speak under the term o , is precisely an object which is outside any possible definition of objectivity. I will not speak of what is happening to objectivity in the field of science, I am speaking about our science in general, you know that since Kant a number of misfortunes have befallen it, a number of misfortunes which all arise, in the heart of this object, from having wanted to give too great a share to certain, "obvious things", and especially those which belong to the field of transcendental aesthetics, like for example holding as obvious the independence, the separation between the dimensions of space and those of time was put to the test in the elaboration of the scientific object

or came into collision with this something that is expressed quite incorrectly as a crisis of scientific reason: in short this whole effort which had to be undertaken in order to see that (4) precisely these two registers of the spatial and temporal dimensions could not, at a certain level of physics, continue to be held as independent variables, a surprising fact, which seems to have posed to some minds indissoluble problems which do not seem nevertheless to be all that worthy of bringing us to a halt, and if we see that it is precisely to the status of the object that we should have recourse to give to the symbolic its exact place in the constitution, in the expression of experience, not to make risky extrapolations from the imaginary into the symbolic.

In truth, the time that is involved, at the level at which there may be posed the problems that come from derealising it in a fourth dimension, has nothing to do with the time which, in intuition, seems indeed to posit itself as a sort of unsurpassable shock of the real, namely something which appears to all of us, and that taking it as an obvious fact, as something which, in the symbolic, could be expressed by an independent variable is simply a categorical error at the beginning.

There is the same difficulty, as you know, at a certain limit of physics, with the body, and here I would say that we are on our own ground, because it is effectively on what has not been done, on what has not been done at the beginning as regards a correct status of the experience that we have here our word to say. We have our word to say since, our experience posits and establishes that no intuition, that no transparency, that no Durchsichtigkeit - since it is Freud's term - which is founded purely and simply on the intuition of consciousness, can be held to be original and therefore valid and therefore cannot constitute the starting point of any transcendental aesthetics, for the simple reason that the subject cannot be in any way situated in an exhaustive fashion in consciousness, since it is firstly and primarily unconscious.

To this must be added, that if it is firstly and primarily unconscious, it is because in the constitution of the subject, we must firstly and primarily hold to be prior to this constitution, a certain incidence which is that of the signifier. The problem is that of the entry of the signifier into the real and to see (5) how from this the subject is born. Does it mean that, if we find ourselves as it were before a sort of descent of the spirit, the apparition of winged signifiers would begin to make their holes in this real all by themselves, in the midst of which there would appear one of these holes which would be the subject. I think that, in the introduction of the real-imaginary-symbolic division, no one imputes such a plan to me. It is a matter today of knowing what is there at first, what it is precisely that allows this signifier to be incarnated. What allows it is of course what we have there to presentify ourselves to one another, our body. Only this body is not to be taken either, for its part, in the pure and simple categories of the transcendental aesthetics. This body is not in a word, constitutable in the way

that Descartes establishes in the field of extension. It is a matter of our seeing that the body in question is not given to us in a pure and simple fashion in our mirror, that even in this experience of the mirror, there can occur a moment where this image, this specular image that we think we have in our grasp, is modified: what we have face to face with us, our stature, our face, our pair of eyes, allows there to emerge the dimension of our own look and the value of the image then begins to change especially if there is a moment at which this look which appears in the mirror begins to look no longer at ourselves, initium, aura, the dawning of a feeling of strangeness which opens the door to anxiety.

The passage from the specular image to this double who escapes me, here is the point at which something happens whose generality, function, presence in the whole phenomenal field we can show, I believe, by the articulation that we are giving to this function of o, and we can show that the function goes well beyond what appears at this strange moment that I wished here simply to pinpoint because its character is well known and also most discreet in its intensity.

How does there occur this transformation of the object, which, from a situatable object, a locatable object, an exchangeable object constructs this sort of private, incommunicable and (6) nevertheless dominant object which is our correlative in the phantasy? Where exactly the moment of this moulting, of this transformation, of this revelation occurs, is, I believe something that, along certain paths, from certain angles which I already prepared for you in the course of the preceding years, can be more than designated, can be explained, and that, in the little schema that I have brought you today on the board something of these conceptions, Auffassungen, in other words of these richtig, correct representations can be given which makes the always more or less opaque, obscure, appeal to intuition, to experience, something durchsichtig, transparent. In other words, to reconstitute for ourselves the transcendental aesthetic which suits us, which suits our experience.

You can hold then as certain, through my discourse, that what is commonly transmitted, I think, about anxiety - not extracted from Freud's discourse but from a part of his discourse, that anxiety has no object - is properly what I am correcting: "it is not without an object, elle n'est pas sans objet", such is exactly the formula on which there ought to be suspended this relationship of anxiety to an object.

It is not properly speaking the object of anxiety, in this "not without (pas sans)", you recognise the formula that I already used in the past about the relationship of the subject to the phallus, "he is not without having it, il n'est pas sans l'avoir".

This relationship of "not being without having" does not mean that one knows what object is involved. When I say "he is not without resources, he is not without guile" that means precisely

that these resources are obscure - at least for me - and that his guile is not of the usual sort.

Moreover even the linguistic introduction of the term sans, sine, which is profoundly correlative to this apposition of haud, non haud sine, not without, is a certain type of conditional liaison, if you wish, which links being to having in a sort of alternation; he is not without having it; but besides, where it is, it is not seen.

Do we not have here precisely, the sociological function of the phallus, provided, of course, that we take it here at the level of the capital letter, at the level of the ^>, in which it incarnates the most alienating function of the subject in (7) exchange itself, in social exchange. The subject as he is involved in it, is reduced to being the bearer of the phallus. This is what makes castration necessary for a socialised society in which there are, as Claud Lévi-Strauss has pointed out to us, prohibitions of course, but also and above all preferences.

This is the true secret, it is the truth of what Claud Lévi-Strauss makes turn around the exchange of women in the structure. Beneath the exchange of women, the phalluses are going to fulfill them. It must not be seen that it is the phallus itself which is at stake. If one sees it, there is anxiety.

I could here branch off onto more than one track. It is clear that with this reference, we have arrived, all of a sudden, at the castration complex. Well then, by God, why not engage ourselves ourselves in it.

Castration, as I have frequently reminded you, the castration of the complex, is not a castration. That is something everyone knows, no-one has the slightest doubt about it, and, a curious thing, people do not dwell on it. It is all the same of interest, this image, this phantasy. Where is it to be situated? Between the imaginary and the symbolic, what is happening? Is it the gelding which is well known from the ferocious practices of war? It is undoubtedly closer to it than to the fabrication of eunuchs.

The mutilation of the penis, of course, is what is evoked by the phantastical threats emanating from the father or from the mother, depending on the epoch of psychoanalysis. "If you do that, it will be cut off you". Moreover it is necessary that this accent of cutting should be given all its importance for there to be sustained the practice of circumcision to which the last time, you heard me make what I might call prophylactic references, namely the remark that the psychic incidence of circumcision is far from being unequivocal, and that I am not the only one to have noted it.

One of the last works, a remarkable one no doubt, on the subject, that of Nunberg, on circumcision conceived in terms of its relations with bisexuality, is there to remind us of something which already a good number of other authors had introduced

before him, that circumcision has just as much the goal, the aim, (8) of reinforcing, by isolating it, the term of masculinity in the man as to provoke the effects, at least in their anxiety-provoking incidence, as to provoke the effects described as those of the castration complex.

Nevertheless, it is precisely this incidence, this relationship, this common denominator of the cut which allows us to bring into the field of castration, the operation of circumcision, of Beschneidung, of arel to say it in Hebrew.

Is there not also here a little something which might allow us to take a further step about the function of castration anxiety. Well then, it is the following, the term which we lack: "I am going to cut it off you", says the Mammy who is described as castrating. Fine, and afterwards, where will the Wiwimacher, as it is called in the observation of little Hans, be? Well then, if we admit that this threat, always presentified by our experience, is carried out, it will be there, in the operational field of the common object, of the exchangeable object, it will be there, in the hands of the mother who has cut it off. And it is indeed this that would be strange in the situation.

It often happens that our subjects have dreams where they have the object in their hands, either because it has been broken off by a gangrene, or because some partner, in the dream, has taken the trouble to carry out the cutting operation, or by some correlative accident or other that is diversely nuanced with uncanniness and anxiety, a particularly disturbing characteristic of the dream, well then, here, to situate for us the importance of this passage of the object, suddenly, to what one could call Zuhandenheit, as Heidegger would say, its handiness, in the field of common objects and the perplexity which results from it, and moreover, this whole passage to the side of the handy, of the utensil, is precisely that which here in the observation of little Hans, is designated for us also by a dream. He introduces the tap fitter, the one who is going to unscrew it, to rescrew it, change the whole discussion of Eingewurzelt, about what is or is not well rooted in the body, into the field, into the register of the interchangeable. And this moment, this phenomenological turning point, here connects up, and allows us to designate the opposition between these two types of object according to their (9) status. When I began to announce the function, the fundamental function in the general establishment of the field of the object, of the mirror stage, what path did I take? Along the plane of the primary identification, the original miscognition of the subject as a whole in his specular image, then the transitivist reference which is established in his relationship with the imaginary other, his fellow, which makes him always badly separated out from this identity with the other and introduces here mediation, a common object which is an object of rivalry, an object, then, whose status is going to begin from the notion of belonging or not: it belongs to you or it belongs to me. In this field, there are two sorts of objects, the ones that can be shared, and those which cannot be. Those which cannot be, when I see them involved all the same in this domain of sharing,

with the other objects, whose status rests entirely on rivalry, this ambiguous rivalry which is at the same time emulation but also agreement, they are priceable objects, they are objects of exchange. But there are some of them, and if I put the phallus in the forefront, it is of course because it is the most illustrious because of the fact of castration; but there are others, as you know, others which you know, the best-known equivalents of this phallus, those which precede it, the turd, the nipple, there are those perhaps which you know less well, even though they are perfectly visible in analytic literature, and we will try to designate these objects when they enter with recognisable freedom into this field where they have only to do, the field of sharing. When they appear, anxiety signals for us the particularity of their status. These objects prior to the constitution of the status of the common object, of the communicable object, of the socialised object, this is what is involved in the o.

We will name these objects, we will draw up a catalogue of them, which is not of course exhaustive, but perhaps also, let us hope so: already just now, I have named three, I would say that as a first approach to this catalogue, there are only two missing and that the totality corresponds to the five forms of loss, of perte, Verlust, that Freud designates in Inhibitions, symptoms (10) and anxiety, as being the major moments of the apparition of the signal.

I want, before going any further, to take up another branch of the switch-line which you saw me a little earlier in the process of choosing, to make a remark, whose asides, I believe, will have for you some illuminating aspects. Is it not strange, significant of something, that in analytic research, there is manifested a quite different lack to the one I already designated in saying that we have not taken a single step in the physiological question of feminine sexuality.

We could accuse ourselves of the same failure as regards male impotence. Because after all, in the process, clearly locatable in its normative phases, of the masculine side of copulation, we are still at the stage of referring ourselves to what can be found in any book of physiology about the process of erection first, then of orgasm.

The reference to the stimulus-response circuit is, when all is said and done, what we satisfy ourselves with, as if the homology between orgasmic discharge and the motor part of this circuit in any kind of action were acceptable. Of course, we are not at that stage, far from it. Even in Freud - and the problem was in fact raised by him - why in sexual pleasure is the circuit not as elsewhere the shortest circuit to return to the level of minimal excitation, why is there a Vorlust, a fore-pleasure, as it is translated, which consists precisely in raising as high as possible this minimal level?

And the intervention of orgasm, namely from what moment is this raising of the level linked as a norm to the preliminary

operation interrupted? Have we in any way given a schema of what intervenes, of the mechanism, if you wish, given a physiological representation of the spoken thing, of what Freud would call the Abfuhrinnervationen, the circuit of innervation which is the support of the bringing into play of the discharge? Have we distinguished it, isolated it, designated it, because it must be (11) considered as distinct from what functioned before, because what was functioning before, was precisely that this process should not go towards its discharge before reaching a certain level of the raising of the stimulus? It is then an exercise of the pleasure function tending to get close to its own limit, namely to the arousal of pain.

So where does this feedback come from? No one dreams of telling us. But I would point out to you, that not I, but the very people who, psychoanalytic doctrine tells us, should tell us normally that the Other must intervene here, because what constitutes a normal genital function is presented to us as linked to oblativity. Let us be told then how the function of giving as such intervenes hic et nunc when one is fucking!

This, in any case, has indeed its interest; for either it is valid, or it is not; and it is certain that in some way there must intervene the function of the Other.

In any case, since an important part of our speculations concern what is called the choice of the love object, and since it is in the disturbances of this love life that there lies an important part of analytic experience, since in this field the reference to the primordial object, to the mother, is held to be capital, a distinction is imposed as to where one should locate this frequent incidence of the fact that for some people the result is that they cannot function as regards orgasm except with prostitutes, and that for others it is only with other subjects chosen in a different register.

As we know from our analyses - the relationship to the prostitute is almost directly meshed into the reference to the mother. In other cases, the deteriorations, degradations of Liebesleben, of the love life, are linked to the opposition between the maternal body which evokes a certain type of relationship to the subject, and the woman of a certain different type in so far as she becomes the support, is equivalent to the phallic object.

How does all of this come about? This picture, this schema (pi), the one that I have once more reproduced here on the upper part of the board allows us to designate what I mean. Is the mechanism, the articulation produced at the level of the (12) attraction of the object, which becomes or not invested for us with this glamour, with this desirable brilliance, with this colour - this is how sexuality is designated in Chinese - which means that the object becomes stimulating precisely at the level of excitation?

This is why this preferential colour will be situated, I would say, at the same level of signal which can also be that of

anxiety, I am saying then at this level here i'(o). So then it will be a matter of knowing why, and I am indicating it immediately so that you can see where I want to get to: by the branching off of the original erogenous cathexis from what is here qua o present and hidden at the same time.

Or that which functions as a sorting element in the choice of love object is produced here at the level of the framing by an Einschränkung, by this narrowing directly referred by Freud to the mechanism of the ego, by this limitation of the field of interest which excludes a certain type of object precisely in function of its relationship with the mother.

The two mechanisms are, as you see, at the two ends of this chain, which begins at inhibition and which finishes with anxiety whose diagonal line I marked out in the table that I gave you at the beginning of this year. We have a right to distinguish two different mechanisms in inhibition and anxiety and precisely to conceive of how both one and the other can intervene from top to bottom of every sexual manifestation.

I add the following that, when I say from top to bottom, I am including in it what in our experience is called transference. Recently I heard an allusion being made to the fact that we in our Society are people who know a good deal about transference. To tell the truth, since a certain work on transference which was done before our Society was founded, I know only one other work which has been evoked, namely that of the year that I devoted to it with you here.

I said a lot of things, certainly in a form which was the most appropriate one, namely in a form that was partly veiled. It is certain that previously in the earlier work on transference to (13) which I have just alluded and which contributed a division as brilliant as that of the opposition between the need for repetition and the repetition of need (the work of Lagache), you see that having recourse to a play on words to designate things - which moreover are not without their interest - is not simply my privilege. But I think that the reference to transference, to limit it uniquely to the effects of repetition, to the effects of reproduction, is something that would altogether deserve to be extended, and that the synchronic dimension risks, through insisting on the historical element, on the element of the repetition of lived experience, risks in any case, risks leaving to one side a whole no less important dimension which is precisely what can appear, what is included, latent in the position of the analyst, through which there lies in the space that he determines, the function of this partial object.

This is what, in speaking to you about transference, if you remember, I designated by the metaphor, which is clear enough it seems to me, of the hand which stretches out towards the log and at the moment of reaching this log, this log bursts into flames, and in the flames another hand appears which stretches out towards the first one.

This is what I also designated, in studying Plato's Symposium, by the function named agalma in the discourse of Alcibiades.

I think that the inadequacy of the synchronic reference to the function of the partial object in the analytic relationship, in the transference relationship, establishes the basis for opening a dossier concerning a domain which I am and am not astonished, not surprised in any case, to see left in the shade, namely that a certain number of failures in the sexual function can be considered as distributed in a certain field of what we can call post-analytic results.

I believe that this analysis of the function of the analyst as the space of the field of the partial object, is precisely *that* before which, from the analytic point of view, Freud brought us to a halt in his article on "Analysis terminable and interminable", and if one starts from the idea that Freud's limit, was - one finds it right through all his observations - (14) the non-perception of what is properly to be analysed in the synchronic relationship between the analysand and the analyst concerning this function of the partial object, one will see there - and if you wish, I will come back to it - the very source of his failure - of the failure of his intervention with Dora, with the woman in the case of feminine homosexuality, one will see in it especially why Freud designates for us in castration anxiety what he calls the limit of analysis, precisely in the measure that he remained for his analysand the seat, the locus of this partial object.

If Freud tells us that analysis leaves man and woman unsatisfied, the one in the field of what is properly called in the case of the male the castration complex and the other about Penisneid, this is not an absolute limit, it is the limit where finite analysis ends with Freud, it is the limit which continues to follow this indefinitely approached parallelism which characterises the asymptote. The analysis which Freud calls indefinite, unlimited (and not infinite) analysis, occurs in the measure that something about which I can at least pose the question as to how it is analysable, had been not, I would say, unanalysed, but revealed only in a partial fashion where this limit is established.

You must not believe that I am saying here, that I am contributing here something again which ought to be considered as completely outside the limits of the blueprint already sketched out by our experience, because after all, to refer to recent and familiar works in the French domain of our work, it is around penis envy, that one analyst made his analysis of obsessionals in particular turn, through the years that made up the time of his writing. How often in the course of previous years have I commented on these observations for you in order to criticise them, to show in them, with what we had at that time to hand, what I considered as their stumbling point. I would formulate here, in a more precise fashion, at the point of explanation that we are getting to, what is involved, what I meant. What was involved - you see it from a detailed reading of these

(15) observations - what was involved if not the filling of this field which I designate as the interpretation to be made of the phallic function at the level of the big Other whose place is held by the analyst and the covering, I would say, of this place with the phantasy of fellatio, and especially concerning the analyst's penis.

A very clear indication. The problem had been seen and let me tell you that it is not by chance, I mean by chance with respect to what I am in the process of developing before you. Only my remark is that here there is only an angle, and an inadequate angle: for, in reality, this phantasy used for an analysis which could not here exhaust what was involved, only rejoins a phantasy symptomatic of the obsessional.

And to designate what I mean, I would go back here to a reference which, in the literature, is really exemplary, namely the well known nocturnal behavior of the Ratman when, having obtained by himself, his own erection in front of a mirror, he goes and opens the door to the landing, to his landing, to the imagined ghost of his dead father, to present, before the eyes of this spectre, the present state of his member.

To analyse what is involved then uniquely then at the level of this phantasy of the fellatio of the analyst so linked by the author in question to what he called the technique of rapprocher (getting closer) to the relationship of distance considered as essential, fundamental to the obsessional structure, specifically in its relationships with psychosis, is, I believe, simply to have allowed the subject, indeed even to have encouraged her to take on this phantastical reaction, which is that of the Ratman, to take on the role of this Other in the mode of presence which is precisely here constituted by death, of this other who looks, by pushing her even, I would say, a little further phantastically simply by the fellatio.

It is obvious that this final point, this final term is only addressed here to those whose practice allows them to put the import of these remarks in their proper place.

(16) I will end on the path on which we will advance further the next time, and to give their meaning to these two images which I have designated for you here in the right corner at the bottom of the board: the first represents a - this is not seen, in fact, at first sight - represents a vase, and its neck. I put the hole of this neck facing you to designate, to clearly stress for you that what is important for me is the edge.

The second is the transformation which can be carried out as regards this neck and this edge. Starting from there, there is going to appear to you the opportuneness of the long insistence that I placed last year on topological considerations concerning the function of identification - I specified it for you - at the level of desire, namely the third type designated by Freud, in his article on identification, the one whose major example



he finds in hysteria.

Here is the incidence and the import of these topological considerations. I told you that I kept you so long on the cross-cap to give you the possibility of intuitively conceiving what must be called the distinction between the object we are speaking about, o , and the object created, constructed starting from the specular relationship, the common object precisely concerning the specular image.

To go quickly, I am going, I think, to remind you of it, in terms which are simple but adequate given the amount of work accomplished previously.

What ensures that a specular image is distinct from that which it represents? It is that the right becomes the left and inversely.

In other words, if we trust this idea - we usually have our reward when we trust even the most aphoristic things in Freud - that the ego is a surface, it is in topological terms of pure surface that the problem ought to be posed: the specular image, with respect to what it duplicates, is exactly the passage from the right-hand glove to the left-hand glove, what one can obtain on a simple surface by turning the glove inside out.

Remember that it was not today or yesterday that I spoke to you about the glove or the hood. The whole dream quoted by Ella (17) Sharpe turns for the most part around this model.

Try the experiment now with what I taught you to know - I hope there are not many who do not know it yet - about the Moebius strip, namely - I recall it for those who have not yet heard tell of it - you obtain very easily in any way whatsoever, by taking this belt, and after having opened it, fasten it again having given it meanwhile a half turn, you obtain a Moebius strip, namely something on which an ant walking along passes from one of these apparent faces to the other face, without needing to pass across the edge, namely a surface with a single face.

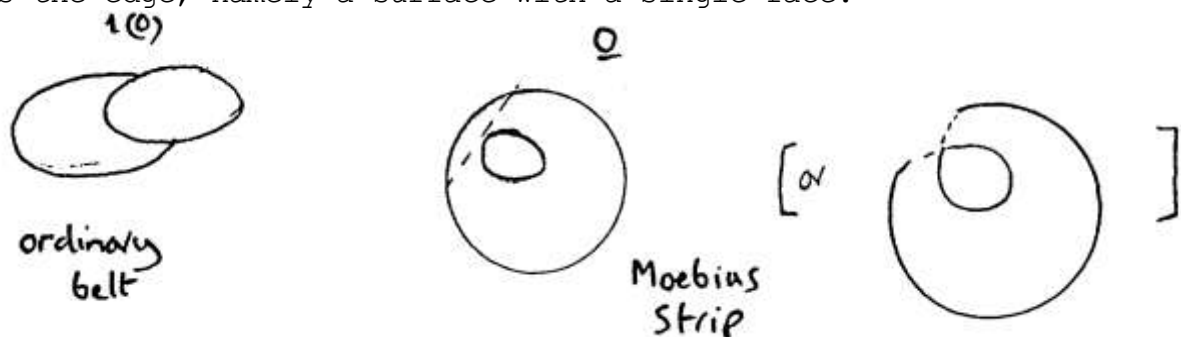

A surface with a single face cannot be turned inside out. For effectively you take a Moebius strip; you make it; you see that there are two ways to make it, depending on whether one turns, one makes the half turn that I spoke about above to the right or to the left and that they do not overlap. But if you turn one of them inside out it will always be identical to itself. This is what I call not having a specular image.

You know on the other hand that I told you that in the cross-cap, when, by means of a section, a cut, which has no other condition than that of rejoining itself, after having included in it the hole-point of the cross-cap, when, I am saying, you isolate a part of the cross-cap, it remains a Moebius strip.

Here is the residual part. I constructed it for you, I am passing it around. It has its interest because, let me tell you: this is o . I give it to you like a host, for you will make use of it subsequently. That is how o is made.

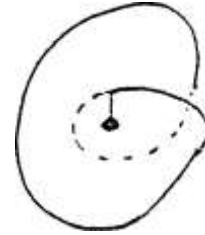

It is made like that when any cut whatsoever has occurred, whether it is that of the cord, that of circumcision, and some (18) others still which we will have to designate.

There remains, after this cut whatever it may be, something comparable to the Moebius strip, something which does not have a specular image. Now then consider carefully what I want to tell you.

The first phase, the vase which is here has its specular image, the ideal ego, constitutive of the world of the common object.

Add to it o in the form of a cross-cap, and separate out in this cross-cap the little object o that I have placed in your hands. There remains, united to $i'(o)$, the remainder, namely a Moebius strip, in other words - I am representing it for you here - it is the same thing as if you make there begin, from the opposite point of the edge of the vase, a surface which connects up with itself, as in the Moebius strip.

Because from that moment, the whole vase becomes a Moebius strip, because an ant walking along the outside enters the inside without any difficulty. The specular image becomes the strange and invasive image of the double, becomes that which happens little by little at the end of the life of Maupassant when he begins by no longer seeing himself in the mirror, or when he perceives in a room something which turns its back on him and regarding which he immediately knows that he is not without some relationship to this ghost, when the ghost turns back, he sees that it is himself.

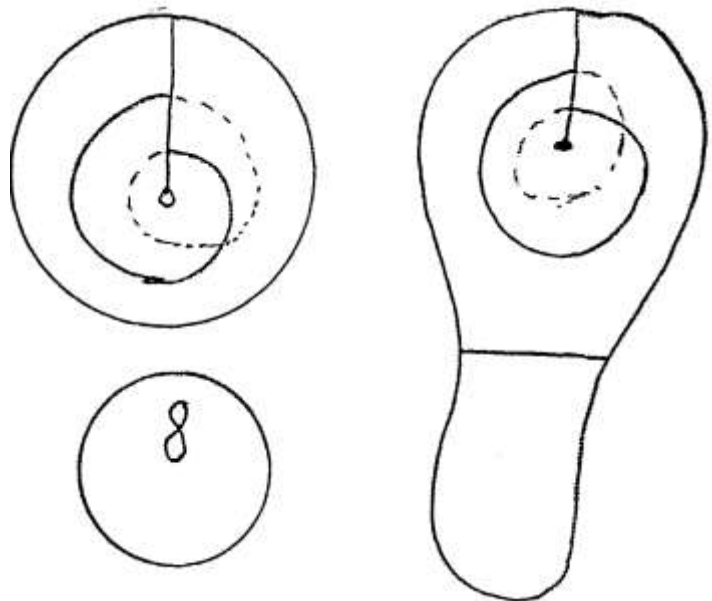

This is what is involved in the entry of o into the world of the real, which it is only returning to. And notice, to end, what is involved. It may seem strange, bizarre to you as a hypothesis,

that something resembles this. Notice however that if we put it outside the operation of the visual field, behave like a blind man, close your eyes for a moment, and feeling your way, follow the edge of this transformed vase. But it is a vase like the other, there is only one hole because there is only one edge. it appears to have two of them. And this ambiguity between the one and the two, I think that those who have simply read a little know that it is a common ambiguity concerning the apparition of the phallus in the field of dream appearance - and not only dreams - of the sexual organ where there apparently is no real phallus. Its ordinary mode of apparition is to appear in the form of two phalluses. There, that's enough for today!

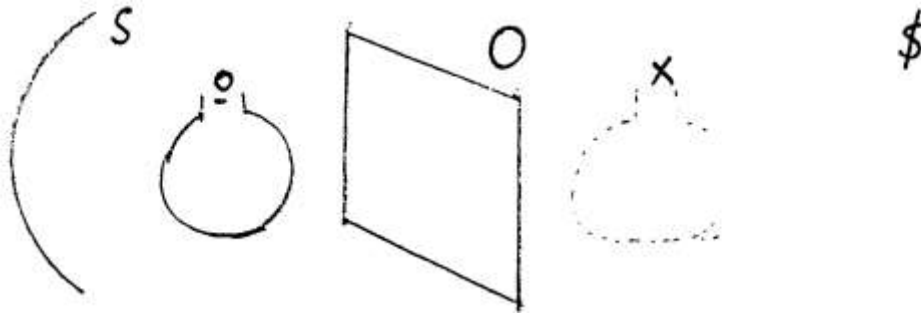

I would like to manage to tell you today a certain number of things about what I have taught you to designate as the object o, this object o towards which the aphorism that I put forward the last time about anxiety orients us, namely that it is not without an object. This is why the object o comes this year into the centre of our remarks. And if effectively it is inscribed in the frame of this anxiety that I took as a title, it is precisely for the reason that it is essentially from this angle that it is possible to speak about it, which means again that anxiety is its only subjective expression.

If the o which we are dealing with here was all the same introduced a long time ago and along the path which brings it to you, was therefore announced elsewhere, it was announced in the formula of the phantasy \$ « o, desire of o, this is the formula of the phantasy qua support for desire.

My first point will be then to recall, to articulate, to add one more specification certainly for those who have heard me, one not impossible for them to master by themselves, even though it does not seem superfluous to me to underline it today. As a first point - I hope to reach point four - and to specify this function of the object in so far as we define it analytically as object of desire, the mirage coming from a perspective that one could call subjectivist, I mean the one which in the constitution of our experience puts the whole accent on the structure of the subject, this line of elaboration that the modern philosophical tradition brought to its most extreme point, let us say, around Husserl, by separating out the function of intentionality, is one that makes us the captives of a misunderstanding, concerning what can be called the object of desire. The object of desire cannot be conceived of in a fashion which teaches us that there is no noeme, no thinking about something which is not turned towards something, the only point around which idealism can turn in its path towards the Real.

(2) Is this how things are as regards desire? For this level of our listening which exists in everyone and which has need of intuition, I would say: "Is the object of desire out in front? This is the mirage that is involved and which has sterilised everything that in analysis intended to advance in the direction described as object relations. It is in order to rectify it that I have already travelled along many paths. It is a new way of accentuating this rectification that I am going to put forward to you now.

I will not make it as developed as it no doubt should be, reserving, I hope, this formulation for a work which will reach you along a different path.

I think that for most of you listening it will be enough to hear the gross formulae with which I believe I can content myself to emphasise today this point which I have just introduced.

You know how, in the progress of epistemology, the isolation of the notion of cause has produced considerable difficulties. It is not without a series of reductions which end up by leading it to the most tenuous and the most equivocal function that the notion of cause was able to be maintained in the development of what in the largest sense we could call our physics.

It is clear on the other hand that whatever reduction one submits it to, what one might call the mental function of this notion cannot be eliminated, reduced to a sort of metaphysical shadow. We clearly sense that there is something, which it is too little to say that is a recourse to intuition, which makes it subsist, which remains around this function of cause, and I claim that it is starting from the re-examination that we can make of it, starting from analytic experience, that the whole Critique of pure reason, brought up to date with our science, could re-establish a correct status of cause.

I scarcely dare to say to introduce it - for after all what I am going to formulate is here only a discourse event and scarcely anchored in this dialectic - I would say then, to fix our aims, what I intend to make you understand. The object, the object o, this object which is not to be situated in anything whatsoever which is analogous to the intentionality of an noeme, which is not in the intentionality of desire, this object ought to be conceived by us as the cause of desire, and, to take up my (3) metaphor of a little while ago, the object is behind desire.

It is from this object o that there arises this dimension whose omission, whose elision, whose avoidance in the theory of the subject constituted the inadequacy up to the present of this whole coordination whose centre manifests itself as a theory of knowledge, gnoseology.

Moreover this function of the object, in the novel structural topology that it requires, is quite tangible in Freud's formulations, and specifically in those concerning the drive.

Let it suffice for me to - if you want to check it against a text, I would refer you to the XXXIInd lecture from the Introduction to psychoanalysis, which can be found in what is called the new series of Vorlesungen, the one I quoted the last time - it is clear that the distinction between Ziel, the goal of the drive and the Objekt is something quite different to what you first think, that this goal and this object should be at the same place. And the statements of Freud that you will find in this place, in the lecture that I am designating for you, employ very striking terms, the first of which is the term eingeschoben: the object slides in it, goes somewhere - it is the same word which is used for the Verschiebung which designates displacement - the object in its essential function as the something which slips away is here highlighted as such, at the level of understanding which is properly our own.

On the other hand, there is, at this level the explicit opposition between two terms äusseres, external, outside, and inneres, inside. It is specified that the object is no doubt to be situated äusseres, on the outside, and on the other hand that the satisfaction of the tendency is only found to be accomplished in so far as it connects up with something which is to be considered in the inneres, the inside of the body, it is there that it finds its Befriedigung, its satisfaction. This also tells you that what I introduced for you as a topological function allows us to formulate in a clear fashion that what has to be introduced here to resolve this impasse, this riddle, is the notion of an outside before a certain interiorisation, of the outside which is situated here, o, before the subject at the locus of the Other, grasps himself in x in this specular form which introduces for him the distinction between the me and the (4) not-me.

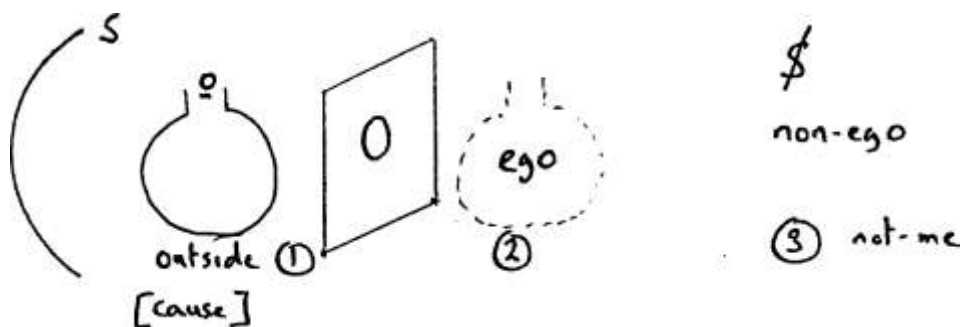

It is to this outside, to this locus of the object before any interiorisation, that there belongs - if you try to take up again the notion of cause - that this notion of cause, I am saying, belongs.

I am going to illustrate it immediately in the simplest fashion to make you hear what I am saying; because moreover I will abstain today from doing any metaphysics.

In order to image it, it is not by chance that I will make use of the fetish as such, where there is unveiled this dimension of the object as cause of desire. Because it is not the slipper, or the

breast, nor whatever it may be in which you incarnate the fetish that is desired; but the fetish as cause of desire which hooks onto whatever it can, onto someone who is not absolutely necessarily the one who is wearing the slipper; the slipper can be in her surroundings; it is not even necessary that she should have the breast: the breast can be in the head. But what everyone knows, is that, for the fetishist, it is necessary that the fetish should be there, that it is the condition upon which desire sustains itself.

And I would indicate here, in passing, this term, little used I believe in German and that the vague translations that we have in French, allow to escape completely; it is, when anxiety is involved, the relationship that Freud indicates with Libidoaushalt. We are dealing here with a term which is between Aushaltung which would indicate something of the order of interruption, of breaking and Inhalt which is the content. It is neither one thing nor the other: it is the support of the libido. In a word, this relationship to the object that I am speaking about to you today, is here directed, indicated in a fashion which allows a synthesis to be made between the signal function of anxiety and its relationship all the same to something that we can call an interruption in the support of the libido.

We are going to come back to it because this is one of the points that I intend to advance before you today. Assuming that I have made myself adequately understood by this reference to the fetish, about the maximal difference that there is between two possible perspectives concerning the object as object of desire, two specifications of what is involved, when I put o first in an essential precession, I will illustrate it a little further. Everything that follows in our discourse will not stop (5) illustrating it further, but already I want you to understand properly what is involved, where our research will lead us: the fact is that it is at the very locus where your mental habits indicate that you should seek for the subject, this something which despite you is outlined as such as subject at the place where for example Freud indicates the source of the tendency, indeed there where there is something which, in discourse, you articulate as being you, there where you say: "I", it is there properly speaking that at the level of the unconscious there is situated o.

At this level, you are o, the object, and everyone knows that this is what is intolerable and not only to discourse itself, which after all betrays it. I am going to illustrate it right away by a remark destined to introduce some displacement, some disturbance even, as regards the ruts in which you are used to leaving the functions described as sadism and masochism as if all that was involved there was the register of a sort of immanent aggression and its reversibility.

It is precisely in the measure that one has to enter into their subjective structure that traits of difference are going to appear, the essential being the one that I am going to designate

now. If sadism can be imaged, in a form which is only an abbreviated schema of the same distinctions that the graph organises, in a formula with four vertices of the kind that I am designating here, we have here the side of O, of the Other, and here that of let us say, of the subject S, of this still

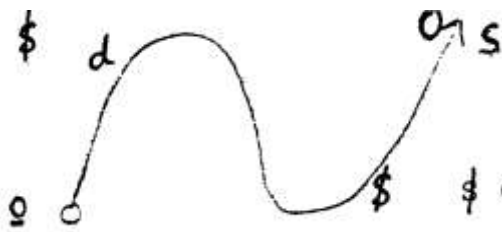

unconstituted I of this subject precisely to be questioned, to be revised within our experience, of which we only know that it cannot, in any case, coincide with the traditional formula of the subject, namely the degree of exhaustion there can be in every relationship with the object.

[0 = 3εα0]

If there is something there called sadistic desire, with all the enigma it involves, it is only articulatable, it is only formulatable in so far as this schize, this dissociation, that it aims essentially at introducing in the other, by imposing on him, up to a certain limit, that which cannot be tolerated, at the exactly adequate limit where there manifests itself, where there appears in the other this division, this gap there is between his (6) existence as subject and what he undergoes, what he can suffer in his body.

And to such a degree is it this distinction, this division, this gap as essential that is involved and a matter of questioning, that in fact it is not so much the suffering of the other that is sought in the sadistic intention, as his anxiety - precisely here I articulate, I designate, I note this little sign, **f 8**, which in the first formulae that I believe in my second lecture of this year, I introduced concerning anxiety, I taught you to read by the term not 0, 1 told you, but zero - the anxiety of the other, his essential existence as subject with respect to this anxiety, this is what the sadistic desire wants to make vibrate.

And it is for this reason that, in one of my past seminars, I did not hesitate to relate its structure as properly homologous to what Kant articulated as a condition for the exercise of pure practical reason, of a moral will properly speaking, and, in a word, to situate there the only point where there can be manifested a relationship with a pure moral good.

I apologise for the briefness of this reminder. Those who were present at this rapprochement will remember it; those who were not able to attend will see, I think, appearing in the not too distant future what I took up of it again in a preface to Philosophy in the boudoir which was precisely the text around which I had organised this comparison.

What is important today and the only thing I want to add another touch to, is that what characterises the sadistic desire is properly that he does not know that in the accomplishment of his act, of his ritual - because it involves properly speaking this type of human action in which we find all the structures of ritual - what he does not know, is what he is looking for, and what he is looking for, is properly speaking to realise himself,

to make himself appear, to whom - since, in any case, this revelation can only remain obscure to himself - to make himself appear as pure object, black fetish. This is how there can be resumed, in its final term, the manifestation of sadistic desire, in so far as the one who is its agent goes towards such a realisation.

(7) Moreover, if you evoke what is involved in the figure of Sade, you will see then that it is not by chance if, what can be extracted from it, what remains of it, through a sort of transubstantiation through the ages, with the imaginary elaboration of his figure throughout the generations, is a form - Man Ray could do no better when he tried to construct his imaginary portrait - precisely a petrified form. Quite different is, as you know, the position of the masochist for whom this incarnation of himself as object is the declared goal, whether he turns himself into a dog under the table or a piece of merchandise, an item that is treated in a contract by giving it over, by selling it as one among other objects that are on the market, in short, his identification with this other object which I called the common object, the object of exchange, this is the route, this is the path on which he seeks precisely what is impossible, which is to grasp himself for what he is, in so far as like all of us he is an o. .

To know why he is so interested by this recognition, which all the same remains impossible, is of course what many particular conditions of his analysis could reveal. But before even being able to understand these particular conditions, there are certain conjunctions which must be properly established here and which are the most structural ones. This is what we are going to try-to do now.

You should clearly understand that I have not said, without elaboration, that the masochist attains his identification with the object. As for the sadist this identification only appears on the stage. Only, even on this stage, the sadist does not see himself, he only sees the remainder. There is also something that the masochist does not see - we will see what perhaps a little later - but this allows me to introduce right away some formulae the first of which is the following: that to recognise oneself as the object of one's desire, in the sense that I am articulating it today, is always masochistic. This formula has the interest of making the difficulty tangible for you, because it is all too convenient to use our little Punch and to say that if there is masochism, it is because the super-ego is very wicked, for example. We know of course that within masochism we make all the necessary distinctions: erogenous masochism, feminine masochism, moral masochism. But as the simple enunciation of this classification has pretty much the same effect as what I would say if I were to say: "There is this glass, there is the Christian faith, and there is the collapse of (8) Wall Street". This should all the same leave us a little dissatisfied. If the term masochism can have a meaning, it would be well to find a more unitary formula for it and if we were to

say that the super-ego is the cause of masochism, we would not be abandoning too much this satisfying intuition, except for the fact that, since we have said before that the object is the cause of desire, we would see that the super-ego shares, at least that it shares the function of this object qua cause, as I have introduced it today in order to make you sense how true it is. I could include it in the catalogue, in the series of these objects as we will have to deploy them before you, by illustrating this place with all the contents, if you wish, that it can have and which are numerable. If I did not do it at the beginning, it was so that you would not lose your heads, by seeing them as contents, and think that they are the same thing that you always discover about analysis. For it is not true. If you think you know the function of the maternal breast, or that of the turd, you know well how much obscurity remains in your minds about the phallus, and when it is the object which comes immediately after that is concerned. I will give it to you all the same, as a way of giving your curiosity something to feed on, namely the eye as such, about it you know nothing at all. This is why it should only be approached with prudence, and for the best of reasons. This is the object involved since, when all is said and done, it is the object without which there is no anxiety, it is because it is a dangerous object. Let us be prudent therefore since I lack, that is to say in the immediate, the opportunity of making appear in what sense I said it - this caught the ear of one of my listeners - I said, two lectures ago, that if desire and the law were the same thing, it is in so far and in this sense that desire and the law have a common object.

It is not enough then in this case to give oneself the consolation that they are, with respect to one another, like the two sides of the wall, or like the front and the back. This is to cheapen the difficulty and, to go straight to the point which makes you sense it, I would say that it is not for any other reason than to make you sense it, that there is value in the (9) central myth which allowed psychoanalysis to take off, namely the Oedipus myth.

The Oedipus myth means nothing else, if not that, at the origin, desire, the desire of the father and the law are one and the same thing, and that the relationship between the law and desire is so close that nothing but the function of the law traces the path of desire, that desire, qua desire of the mother, for the mother, is identical to the function of the law. It is in so far as the law prohibits her that it imposes desiring her: for after all the mother is not in herself the most desirable object. If everything is organised around this desire for the mother, if it is starting from there that it is posed that the woman one should prefer - for this is what is in question - should be other than the mother, what does that mean, if not that a commandment is imposed, is introduced into the very structure of desire; that in a word one desires according to the commandment. What does the whole myth of Oedipus mean, if not that the desire of the father is what has made the law.

From this perspective masochism takes on the value and function of appearing and clearly appearing - it is its only value for the masochist - when desire and the law are found together; for what the masochist tries to make appear - and I add, on his little stage, for one must never forget this dimension - is something where the desire of the Other lays down the law.

We see immediately one of its effects: it is that the masochist himself appears in this function that I would call lopsided (dejet) with respect to this object of ours, the o of which we speak under the appearance of waste (dejetete), of what is thrown to the dogs, on the rubbish heap, in the dustbin, to the rejection of the common object, for want of being able to put it elsewhere.

It is one of the aspects in which there can appear the o as it shows itself in perversion. And this does not exhaust in any way what we can only circumscribe by going around it, namely the function of o. But since I have taken this perspective of masochism, since I have introduced it, we must give ourselves other points of reference to situate this function of o. You see one of them at the level of masochism. I remind you that one must first take for its function of gross correlation, that the central effect of this identity which conjoins the desire of the (10) father and the law, is the castration complex in so far as when the law is born by this moulting, this mysterious mutation of the desire of the father after he had been killed, the consequence is, just as much in the history of analytic thought as in everything that we can conceive of as the most certain liaison, is in any case the castration complex.

This is why you have already seen appearing in my schemas the notation (-<J>) at the place where o is missing.

Therefore, a first point today: I spoke to you about the object as cause of desire. Second point, I told you: to recognise oneself as the object of one's desire, is always masochistic; I pointed out to you in this connection what was taking shape for us as a presentation - in a certain incidence of the super-ego, I indicated to you a particularity that is in some way depreciated - of what is happening at the place of this object o in the form of (-\$>).

We come to our third point, the one which concerns precisely this possibility of the manifestations of the object o as lack. It is structural to it. And it is in order to make it conceivable that this schema, this image designed to make it familiar to you has been presentified and recalled to you for some time past.

The object o at the level of our analytic subject, of the source of what subsists as body which in part, for us hides from us as I might say its own will, this object o is this rock of which Freud speaks, this final irreducible reserve of libido whose contours it is so pathetic to see him literally punctuating in these texts every time that he encounters it. I will not end my lecture

today without telling you where you should go to renew this conviction. This little o, at the place where it is, at the level where it could be recognised if it were possible - because of course a little earlier I told you that to recognise oneself as object of one's desire is always masochistic - if it were possible, the masochist only does it on the stage. And you are going to see what happens when he can no longer remain there, on the stage. We are not always on the stage, even though the stage stretches very far, and even into the domain of our dreams. And qua not on the stage and remaining on this side of it, and trying (11) to read in the Other what he returns from, we find nothing but the lack here at X (schema).

It is this liaison, coordination between the object and its necessary lack there where the subject is constituted at the locus of the Other, namely as far as possible, beyond even what can appear in the return of the repressed and constituting the Urverdrangung, the irreducible of the incognito, because moreover we cannot say absolutely unknowable because we are talking about it, it is here that there is structured, that there is situated what, in our analysis of the transference, I produced before you by the term agalma.

It is in so far as this empty place is aimed at as such that there is established the always more or less neglected - and for good reasons - dimension of transference. That this place as such can be circumscribed by something which is materialised in this image, a certain edge, a certain opening, a certain gap where the constitution of the specular image shows its limits, this is the elective locus of anxiety.



This phenomenon of edge, in what opens like this window on privileged occasions, marks the illusory limit of this world of recognition, of the one that I call the stage. That it should be linked to this edge, to this framing, to this gap which is illustrated in this schema at least twice, in this edge here of the mirror and moreover in this little sign, ^, that this is the locus of anxiety, is what you ought always to retain as the signal of what is to be sought for in the middle.

The text of Freud to which I would ask you to refer, for it is a text that is always more stupefying to read because of this double aspect of weaknesses, of inadequacies which always present themselves to novices at the beginning as the first things to be picked out in the text of Freud and of the depth with which everything that he comes up against - reveals the degree to which Freud was here around this very field that we are trying to designate, of course, it is necessary first of all for you to be familiar with the text of Dora - can, for those who heard my discourse on the Symposium, recall this dimension always eluded when transference is involved, and of the other dimension in parenthesis, namely that transference is not simply something that reproduces a situation, an action, an attitude, an old (12) trauma, and repeats it; the fact is that there is always another coordinate, the one on which I put the accent in

connection with the analytic intervention of Socrates, namely specifically in the case where I evoke a love present in the real, and that we can understand nothing about transference if we do not know that it is also the consequence of that love, that it is in connection with this present love - and analysts should remember it during analyses - of a love which is present in different ways, but that at least they should remember it, when it is there visible, that it is in function of what we could call this real love that there is established what is the central question of transference, namely the one the subject poses concerning the agalma, namely what he is lacking. For it is with this lack that he loves. It is not for nothing that for years I have been repeating to you that love is to give what one does not have. This is even the principle of the castration complex: in order to have the phallus, in order to be able to make use of it, it is necessary precisely not to be it.

When one returns to the conditions where it appears that one is it - for one is it just as much for a man, there is no doubt about it, and for a woman we will say again through what incidence she is led to become it - well then it is always very dangerous.

Let it suffice for me to ask you before leaving you to reread attentively this text entirely devoted to the relationships between Freud and his patient, this girl - I remind you - of whom he says that analysis makes there appear that it is essentially around an enigmatic disappointment concerning the birth in her family, the apparition in her household of a little child that she has been oriented towards homosexuality.

With an absolutely admirable touch of the science of analogy, Freud perceives what is involved in this demonstrative love of the young girl for a woman who has undoubtedly a suspect reputation, with regard to whom she behaves herself, Freud tells us, in an essentially virile fashion. And if one limits oneself to reading simply what is there, God knows, virility, we are so used to speaking about it without knowing that we do not see that what he intends to emphasise there, is what I tried to presentify before you in all sorts of ways in stressing that it is the function of what is called courtly love: she behaves like the (13) knight who suffers for his lady, is content with the most impoverished, the least substantial favours, who prefers even to only have those and who finally, the more the object of his love goes in the opposite direction to what one could call reward, the more he overestimates and raises this object to an eminent dignity.

When manifestly the whole public clamour cannot fail to impress on her that effectively the behaviour of her well-beloved is extremely doubtful, this dimension of exaltation only sees there being added to it the supplementary and reinforced aim of saving her. All of this is admirably underlined by Freud and you know how the girl in question had been brought to his consultation room: it is in the measure that one day, this liaison carried out

what is more really in defiance of the whole city, in a style whose relationship of provocation with respect to her family Freud perceived right away - and it appears very quickly and very certainly that it is her father - this liaison comes to an end because of an encounter. The young girl in the company of her beloved, we are told, passes, on the way to the office of the father in question, this father who throws an irritated glance at her; the scene then happens very quickly. The person for whom, no doubt, this adventure is only a rather obscure distraction and who is beginning obviously to have enough of it and who, no doubt, does not want to expose herself to great difficulties, tells the young girl that this has lasted long enough and that that is it for the future, that she should stop sending her, as she does everyday, countless flowers, following her everywhere she goes. And at this the girl immediately throws herself over a place as regards which you will remember at one time I explored minutely the maps of Vienna to allow its full meaning to be given to the case of little Hans, I would not go so far today as to tell you the place where something very probably can be found something comparable to what you still see over by Boulevard Pereire, namely a little ditch at the bottom of which there are the rails of a little railway which is not working anymore, this is where the girl throws herself, niederkommt, falls down.

There are many things to say about this niederkommen. If I am introducing it here, it is because it is an act of which it is not sufficient to mention, to recall, the analogy with the meaning of niederkommen in the event of giving to birth, to exhaust its (14) meaning. This neiderkommen is essential for every sudden relating of the subject with what he is as o.

It is not for nothing that the melancholic subject has such a propensity and one always accomplished with a blinding, disconcerting, rapidity for throwing himself through the window.

The window, in so far as it reminds us of this limit between the stage and the world, indicates to us what is meant by this act by which, in a way, the subject returns to this fundamental exclusion he feels himself to be in at the very moment that there is conjoined in the absolute of a subject, which we analysts alone can have an idea of, this conjunction between desire and the law.

This is properly what happens at the moment of the encounter between the couple, the knight of Lesbos and her Kareninian object, if I can express myself in this way, with the father. For it is not enough to say that the father threw an irritated glance to understand how there could have been produced this passage a l'acte. There is something which belongs there to the very basis of the relationship, to the structure; because what is involved? Let us say it briefly in terms that I believe sufficiently prepared for you to understand them: the girl for whom the attachment to the father and the disappointment because of the birth, of a young brother, if I remember rightly, this disappointment was the turning point of her life, is going then

to do what? Make of her castration as a woman what the knight does with respect to his lady, to whom precisely he offers the sacrifice of his virile prerogatives to make of her the support of what is linked in the relationship by an inversion to this sacrifice itself, namely the putting in place of the lack, precisely what is lacking to the field of the other, namely the supreme guarantee, the fact that the law is well and truly the desire of the father, that one is sure of it, that there is a law of the father, an absolute phallus,^ .

No doubt resentment and vengeance are decisive in the relationship between this girl and her father. That is what resentment and vengeance are: this law, this supreme phallus, here is where I put it. She is my lady, and since I cannot be your submissive woman, and I your object, I am the one who sustains, who creates, the idealised relationship to what is inadequate in myself, what was repulsed. Let us not forget that the girl had given up on, had let go the culture of her (15) narcissism, her toilet, her coquetry-/ her beauty, to become the servant knight of the lady.

It is in the measure that all of this is contained in this simple encounter and at the level of the father's look, for whom, nevertheless on this whole scene which had completely gained the assent of the subject, that this scene falls under the look of the father, that there is produced what we could call in referring ourselves to the first table that I gave you about the coordinates of anxiety this supreme embarrassment, that emotion - consult this table, you will see its exact coordinates - emotion is added to it by the sudden impossibility of facing up to the scene her friend had put before her; two essential conditions of what is properly speaking called passage a l'acte, (and here I am addressing myself to someone who asked me to anticipate a little on what I can say about this distinction from acting out, we^will have to come back to it), the two conditions of the passage a l'acte as such are realised. What comes at this moment to the subject, is her absolute identification to this o, to which she is reduced. Confrontation with this desire of the father upon which all her behaviour is constructed, with this law which is presentified in the look of the father, it is through this that she feels herself identified and at the same moment, rejected, ejected off the stage.

Only the "letting fall", the "letting oneself fall" can realise it. I do not have the time today to indicate to you the direction that this takes, namely that the celebrated notation by Freud of the identification to the object in mourning, as being something on which there is brought to bear something which he expresses as the revenge of the one who is experiencing the mourning, is not enough. We carry on mourning and we experience the devaluating effects of mourning in so far as the object that we are mourning for was, without us knowing it, the one which had become, that we had made the support for our castration.

Castration returns to us; and we see ourselves for what we are,

in so far as we would be essentially returned to this position of castration. You see that I am running out of time and that here I can only give an indication; but what well designates the degree to which this is what is involved there are two things: it is the way in which Freud senses that however spectacular the advances made by the patient in her analysis, it runs off her (16) like water off a duck's back, and if he designates specifically this place which is that of o in the mirror of the Other by all possible coordinates, without of course having the elements of my topology, but one could not say it more clearly, for he says there: "Here, what I come to a halt before, what I run into, (says Freud), is something like what happens in hypnosis". Now what is it that happens in hypnosis? It is that the subject is capable of reading in the mirror of the Other everything that is there at the level of this little vase in dots: one goes for everything that is specularisable. It is not for nothing that the mirror, the stopper of the carafe, indeed the look of the hypnotiser, are the instruments of hypnosis. The only thing that one does not see in hypnosis, is precisely the stopper of the carafe itself, nor the look of the hypnotiser which is the cause of hypnosis.

The cause of hypnosis is not seen in the consequences of hypnosis. The other reference: the doubt of the obsessional. And on what is brought to bear the radical doubt which ensures also that the analyses of obsessionals are pursued for a long time and very nicely? The treatment of an obsession is always a real honeymoon between the analyst and the analysand, in so far as this centre where Freud designates very well the sort of discourse spoken by the obsessional, namely: "He is really a very nice man; he tells me the most beautiful things in the world, the trouble is that I do not quite believe them". If it is central, it is because it is there, in x, in the case of the young homosexual, what is involved, is precisely what ought to illuminate us, namely a certain promotion of the phallus as such, to the place of o and it is here - I feel scrupulous about saying it, because moreover it is a marvellously illuminating text that I do not need to give you the other properties of, but I would beseech you not to take as one of these meaningless repetitions that we have become used to, since that on which, the man in question, who was discovering things at that time, ends his text, namely the distinction between constitutional elements and historical elements - it does not matter which ones - in the determination of homosexuality, and the isolation, this being as such the proper field of analysis, of the object, the object choice (Objektwahl) distinguishing it as such, as including the (17) mechanisms which are original, everything turns effectively around this relationship between the subject and o.

The paradox is the one which is close to what I indicated to you the second time as the point where Freud bequeathed us the question of how to operate at the level of the castration complex, and designated by something which is inscribed in the observation which I am astonished is not a more common object of astonishment among analysts, that this analysis ends with Freud

dropping her.

For with Dora - I will come back to it - we can better articulate now what happened; not everything is awkwardly done, far from it, and one can say that if Dora was not completely analysed, Freud sees clearly to the very end. But here, where the function of small o, of the object, is in a way so prevalent in the observation of the homosexual that it even got to the stage of passing into the real in this passage a l'acte whose symbolic revelation he nevertheless understands so well, Freud gives up: "I will not be able to do anything", he says to himself and he passes her on to a female colleague. It is he who takes the initiative of letting her fall.

I will leave you on this term to give you an opportunity of reflecting on it, because you will clearly see that this concern leads us to aim at an essential reference in the analytic handling of the transference.

Seminar 9 : Wednesday 23 January 1963

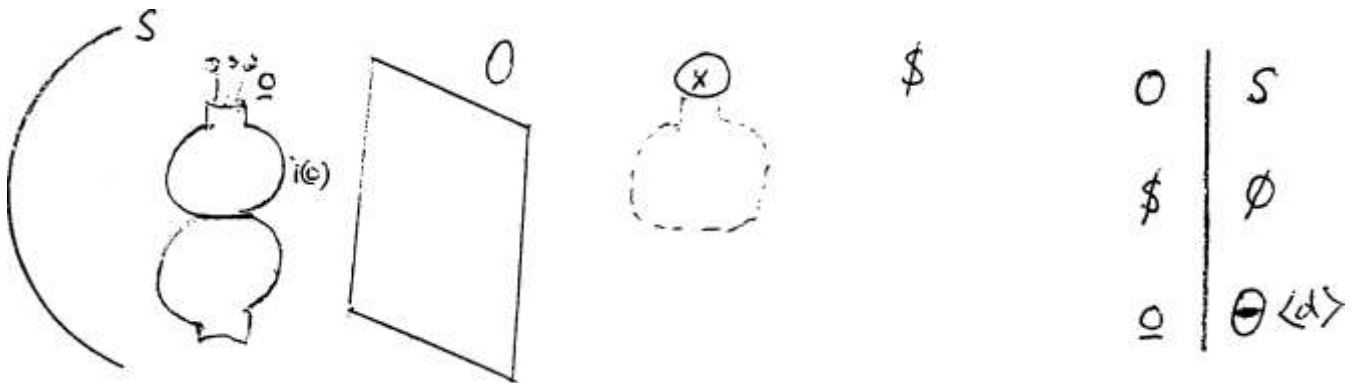

Today we are going to continue speaking about what I am designating for you as the small o.

To maintain our axis, in other words, in order not to allow you the opportunity of drifting off because of my very explanations, I will begin by recalling its relationship to the subject. Nevertheless, what we have to say, to emphasis today, is its relationship to the big Other, the other connoted by an O, because, as we shall see, it is essential to understand that it is to thic. Other that it owes its isolation, that it is constituted as a remainder in the relationship of the subject to the Other. That is why I have reproduced this schema, the homologue of the apparatus of division. The subject on the top right in so far as by our dialectic it takes its origin from the function of the signifier, the hypothetical subject S at the origin of this dialectic constitutes itself at the locus of the Other as marked by the signifier, the only subject our experience has access to, inversely suspending the whole existence of the Other on a guarantee which is lacking, the barred Other: \bar{O} .

But from this operation, there is a remainder: it is the o. The last time, I initiated, I put before you as an example, not a unique example - for behind this example, that of the case of female homosexuality, there was profiled that of Dora - I put before you as a structural characteristic of this relationship of the subject to o, the essential possibility, what could be called (2) the universal relationship concerning the o, for at every level you will always find it, and I would say that this is the most characteristic connotation, since precisely it is linked to this function of the remainder. This is what I called, borrowed from the vocabulary and the reading of Freud in connection with the passage a l'acte which brought him his case of female

homosexuality, the letting drop, the niederkommen lassen. And you no doubt remember that I ended with this remark that, strangely, this is what in connection with the case marked the response of Freud himself to a difficulty that is quite exemplary, for in everything that Freud testified to us by his action, by his behaviour, by his experience, this letting drop is unique at the same time as it is almost so manifest, so provokative in his text, that for some people reading it it becomes quasi-invisible.

This letting drop is the essential correlate that I indicated to you the last time of the passage a l'acte. Again from what side is this letting drop seen, in the passage a l'acte? From the side of the subject, precisely. The passage a l'acte is, if you wish, on the side of the subject in the phantasy in so far as she appears effaced by the bar to the maximum extent. It is at the moment of greatest embarrassment that, with the behavioural addition of emotion as disorder of movement, the subject, as one might say, precipitates herself from where she is, from the locus of the stage where it is only as a fundamentally historicised subject that she can maintain herself in her status of subject, that essentially she topples off the stage, this is the very structure as such of the passage a l'acte.

The woman in the observation on female homosexuality jumps over the little barrier which separates her from the culvert where there runs the little semi-underground tramway in Vienna, Dora at the moment of embarrassment into which - I pointed it out to you (3) a long time ago - the trick sentence, the clumsy trap of Mr K puts her: "My wife means nothing to me", goes into action (passee a l'acte).

The slap, the slap which here can only express nothing but the most complete ambiguity: is it Mr K or Mrs K that she loves? It is certainly not the slap which will tell us. But such a slap is one of the signs, of these crucial moments in destiny which we can see reverberating from generation to generation with its value as a switching point in a particular destiny.

This direction of escaping from the stage, is what allows us to recognise and, you will see, to distinguish the passage a. l'acte with its proper value, from this something quite different which is acting-out.

Will I tell you of another very obvious example? Who would dream of contesting this label for what is called a fugue? And what is a fugue in a subject, always put in a more or less infantile position, who throws himself into it, if not this sort of exit from the stage, this vagabond departure into the pure world, where the subject sets off to search for, to encounter something everywhere refused: he froths with rage (il se fait mousse), as they say; of course, he comes back, he returns, this can be the opportunity to become enraged; and this departure, is indeed this passage from the stage to the world for which moreover it was so useful that, in the first phases of this discourse on anxiety, I

posed for you this essential distinction between two registers of the world, the place where the real hurries onto this stage of the Other where man as subject has to constitute himself, to take his place as the one who carries the word, but who can only carry it in a structure which however truly it is established is a structure of fiction.

I will come, in order to tell you at first how this remainder as such asserts itself in the most characteristic way, to speak to (4) you today first of all - I mean before going any further in the function of anxiety - about acting-out.

It may no doubt seem to you, if not astonishing, at least another detour - a further detour, is it not a detour too many? - to hear me in a discourse about anxiety on something which at first sight seems rather to be an avoidance of it. Observe, nevertheless, that you are only rediscovering here what an interrogation which was essential at the beginning, has already punctuated in my discourse, namely whether anxiety is not so absolute a mode of communication between the subject and the Other that to tell the truth one could ask oneself whether anxiety is not properly speaking what is common to the subject and to the Other.

I put here, in order to find it again later, a little mark, a white stone, namely one of the traits which gives us most difficulty and which we must preserve, namely that no discourse about anxiety can fail to recognise that we have to deal with the phenomenon of anxiety in certain animals. And after all, what is there here at first, if not a question, namely how can we be so sure of a feeling in an animal, and perhaps only of this one. For it is the only one that we can have no doubts about when we encounter it in an animal, rediscovering here in an exterior form this character which I already noted anxiety involves, of being this something which does not deceive.

Having posited therefore the outline of what I hope to cover today, I recall first of all as regards this o towards which we advance through its relationship to the Other, to the O , some remarks by way of reminder, and starting from the following, which was already indicated in what I told you up to now, that (5) anxiety - you see it emerging in this schema which here reflects tachygraphically and I apologise if it appears at the same time a little approximate - anxiety, we see, emerging in conformity with the last thinking of Freud, anxiety is a signal in the ego; if it is a signal in the ego, it ought to be there somewhere, at the locus of the ideal ego in the schema; and if it is somewhere, I think I have already sufficiently shown you to begin with that it must be here at x , and it is a phenomenon of the edge in the imaginary field of the ego, this term of edge being legitimated since it is based on the affirmation of Freud himself, that the ego is a surface, and even, he adds, a projection of a surface; I recalled that at one stage. Let us say therefore that it is a colour, as I might say.

I will justify later, when I have the opportunity, the

metaphorical use of this term colour, which appears at the edge of the specular surface itself, itself an inversion, qua specular, of the real surface. Here, let us not forget, it is a real image that we call $i(o)$, the ideal ego.

The ideal ego, this function through which the ego is constituted by the series of identifications to what? To certain objects, those in connection with which Freud proposes to us in Das Ich und das Es, essentially the ambiguity between identification and love.

You know he underlines that the problem of this ambiguity leaves him, Freud, perplexed. We will therefore not be astonished that this ambiguity is something we ourselves can only approach with the help of formulae putting to the test the very status of our own subjectivity in discourse - by that I mean in learned or teaching discourse - an ambiguity designated by the relationship of what for a long time I emphasised before you in the proper place, as the relationship between being and having.

(6) The object of identification, o , to underline by a reference point, in the salient points even of Freud's work, is the identification which is essentially at the source of mourning, for example. This o , object of identification, is also o as love object only in so far as it, this o , is what makes of the lover, to use a medieval and traditional term, what tears away this lover metaphorically, to make of him, in proposing himself as lovable, eromenon, by making of him eron the subject of a lack, therefore that through which he constitutes himself properly in love, what gives him, as I might say, the instrument of love, namely - we find it again - that one loves, that one is a lover with what one does not have.

o is called o in our discourse, not simply as the function of an algebraic identity that we specified the other day, but, if I can put it humorously, because it is what one no longer has (n'a plus) .

This is why one can rediscover along the regressive path, namely in the form of identification to being, this o , what one no longer has. It is exactly what makes Freud put the term regression exactly at the point where he specifies the relationships between identification and love. But in this regression where o remains what it is, the instrument, it is with what one is that one can, as I might say, have or not have.

It is with this real image constituted here, when it emerges, as $i(o)$, that one catches or not what remains in the neck of this image, the multiplicity of the o -objects represented in my schema by the real flowers caught up or not in the constitution, thanks to the concave mirror at the back, of the symbol of something, let us say, which ought to be rediscovered in the structure of the cortex the foundation for a certain relationship between man and the image of his body and different objects which can be
(7) constituted from this body are or not caught, grasped at the

moment when i(o) has the opportunity of constituting itself.

This is why we ought to grasp that before the mirror stage what will be i(o) is there in the disorder of small o's which there is no question yet of having or not. And it is to this that there corresponds the true meaning, the most profound meaning to be given to the term autoerotism is that one lacks self (on manque de soi), as I might say, entirely. It is not the external world that one lacks, as it is incorrectly put, it is oneself.

Here is the possibility of this phantasy of the fragmented body which some of you have recognised, have encountered, in schizophrenics. This does not for all that allow us to decide on the determinants of this phantasy of the fragmented body which those of whom I am speaking have seen being outlined in the schizophrenic. And this is why I also highlighted the merit of a recent research concerning the coordinates of these determinants of schizophrenics, a research which did not claim at all to exhaust these determinants, but which connoted one of their traits by remarking strictly and nothing more in the articulation of the mother of the schizophrenic what her child was when he was in her belly: nothing more than a diversely convenient or embarrassing body, namely the subjectification of o as pure real.

Let us observe once again this moment, this state before the emergence of i(o), before the distinction between all the small o's and this real image with respect to which they are going to be this remainder that one has or does not have.

Yes, let us make this remark: if Freud tells us that anxiety is this phenomenon on the edge, this signal at the limit of the ego, (8) against this other thing, x, which here must not appear in so far as o, the remainder, is abhorred by the Other. How did it happen that this movement of reflection, the guides, the rails of experience led the analysts, Rank first of all and Freud following him on this point, to find the origin of anxiety at this pre-specular, pre-autoerotic level, at this level of birth where who could dream - nobody dreamt of it - in the analytic concert of speaking about the constitution of an ego. There is here something which proves in effect, that if it is possible to define anxiety as a signal, an edge phenomenon in the ego when the ego is constituted, it is surely not exhaustive. This we rediscover quite clearly in one of the phenomena best known to accompany anxiety, those which one designates, in understanding them analytically in an undoubtedly ambiguous fashion to judge from the divergences - for we will have to come back to them - they are the phenomena precisely most contrary to the structure of the ego as such, the phenomena of depersonalisation. This gives rise to the question, that we cannot avoid, of situating depersonalisation authentically.

You know the place that this phenomenon took on in certain reference points proper to one, or several, authors of the French School to whom I already had to refer. I think it will be easy to recognise the relationship between these reference points and

what I am developing here, I mean to assume that these reference points are not foreign to the sketches that I was previously able to give of it. The notion of distance, here almost tangible, in the necessity that I have always marked, precisely of the relation between this distance and the existence of the mirror, which gives to the subject this distancing from himself that the dimension of the Other is designed to offer to him, but this does (9) not enable us to conclude either that any bringing closer can give us the solution to any of the difficulties that are generated by the necessity of this distance.

In other words, it is not because the objects are invasive, as I might put it, in psychosis, which constitutes their danger for the ego. It is the very structure of these objects which makes them unsuitable for ego-ising (a la moisation). This is what I tried to make you grasp with the help of topological references, metaphors if you wish - but I believe that is going too far - which I made use of in so far as they introduce the possibility of a non-specularisable shape into the structure of certain of these objects. Let us say that phenomenologically, depersonalisation begins - let us end our sentence with something which seems to be obvious - with the non-recognition of the specular image. Everyone knows how tangible this is in clinical practice, how frequently it is from not being able to find himself in the mirror or in something else that is analogous, that the subject begins to be seized by depersonalising vacillation. But let us articulate more precisely that this formula given by the event is insufficient, namely that it is because what is seen in the mirror is anxiety-provoking that this cannot be proposed to the recognition of the Other, and to refer to a moment that I marked as characteristic of this mirror experience, as paradigmatic of the constitution of the ideal ego in the space of Other, that a relationship to the specular image is established such that the infant is not able to turn his head, in accordance with this movement which I described to you as familiar, towards this Other, this witness, this adult who is there behind him, to communicate his smile to her, the manifestations of his jubilation about something which makes him (10) communicate with the specular image, that another relationship is established of which he is too captive for this movement to be possible; here the purely dual relationship dispossesses - this feeling of the relationship of dispossession marked by clinicians in psychosis - dispossesses the subject of this relationship to the big Other.

The specularisation is strange, and, as the English say, "odd", unsymmetrical, it is the Horla of Maupassant, the outside of space, in so far as space is the dimension of what can be superimposed. But here at the point that we are at, to stop at what is signified by this separation, this cut linked to the anxiety of birth, in so far as something imprecise exists there from which there are generated all' sorts of confusions. To be honest I do not have the time and I can only indicate it. I will come back to it. You should be aware however that at this place it would be well nevertheless to have great reservations about

the structuring of the phenomenon of anxiety. Therefore it will be enough for you to refer to the text of Freud. Freud - as you will see - sees its convenience in the fact that at the level of the anxiety of birth there is constituted a whole constellation of movements, principally vasomotor, respiratory, which he says is "a real constellation", and it is this that will be carried over into its function of signal in the way, he tells us, an hysterical attack is constructed, being itself the reproduction of inherited movements for the expression of certain emotional moments.

Undoubtedly this is altogether inconceivable because precisely of the fact that it is impossible at the beginning to situate this complexity in a relationship with the ego which would allow it subsequently to serve as a signal of the ego, except through the mediation of what we have to seek in terms of structure in the relationship between i(o) and this o.

(11) But in that case the characteristic separation at the beginning, the one which allows us to approach, to conceive of the relationship, is not the separation from the mother.

The cut involved is not that between the child and the mother. The fashion in which the child originally dwells in the mother, poses the whole problem of the character of the relationships of the egg with the body of the mother in mammals, which you know has a whole aspect which makes it with respect to the body of the mother a foreign body, a parasite, a body encrusted by the hairy roots of its chorion in this organ that is specialised to receive it, the uterus, with the mucus of which it has a certain involvement.

The cut which interests us, the one which makes its mark on a certain number of clinically recognisable phenomena and for which then we cannot avoid it, is a cut which, thank God for our conception, is much more satisfying than the cut of the child who is born, when he drops into the world with what? With his envelopes. I have only to refer you to any book of embryology whatsoever which is less than a hundred years old for you to be able to grasp in it that, in order to have a complete notion of this pre-specular totality which is o, you have to consider these envelopes as elements of the body. It is starting from the egg that these envelopes are differentiated, and you will see there very curiously that they are so in such a fashion that they illustrate - I have confidence enough in you after our work of last year around the cross-cap - that you may find very simply the degree to which on the schemas illustrating these chapters of embryology on the envelope, you can see being manifested all the varieties of this inside to outside, of this outside in which the (12) foetus floats, itself enveloped in its amnion, the amniotic cavity itself being enveloped in an ectodermic lamina and presenting its face towards the outside in continuity with the endoblast.

In short the analogy between what is detached with the cut

between the embryo and its envelopes, and this separation on the cross-cap of a certain enigmatic o on which I insisted, is tangible here. And if we have to rediscover it subsequently, I think that I have today sufficiently indicated it for that. There remains for us to do today then what I announced to you, concerning what is indicated by acting-out about this essential relationship between o and 0.

In opposition to the passage a l'acte, all acting-out presents itself with certain characteristics which are going to allow us to isolate it. The profound, necessary relationship between acting-out and this o is where I want to lead you, in a way by the hand, in order not to let you drop. Observe moreover in your clinical surveys the degree to which being held by the hand in order not to be let drop is altogether essential in a certain type of relationship of the subject to something which when you encounter it you can absolutely designate as being for him an o. This gives rise to unions of a very widespread type which are not for all that any easier to manage, because moreover the o that is involved can be for the subject the most inconvenient super-ego.

The type of mother that we call, not inappropriately, but without knowing absolutely what we mean, a phallic woman - I would advise you to be careful before applying this label. But if you are dealing with someone who tells you that in the very measure itself that an object is most precious to her, inexplicably she (13) will be appallingly tempted not to hold on to this object if it falls, expecting something or other miraculous from this sort of catastrophe and that the most beloved child is precisely the one that one day she inexplicably lets drop; and you know that in Greek tragedy - this has not escaped the perspicacity of Giraudoux - this is the most profound complaint of Electra about Clytemnestra; it is that one day she had left her fall from her arms.

Here then, you can identify what it is appropriate on this occasion to call a phallic mother. There are no doubt other modes; we are saying that this one appears the least deceptive. And now let us go into acting-out in the case of female homosexuality. If the suicide attempt is a passage a l'acte, I would say that the whole adventure with the woman of doubtful reputation, who is raised to the function of ^supreme object, is an acting-out. If Dora's slap is a passage a l'acte, I would say that all the paradoxical behaviour, that Freud discovers immediately with such perspicacity, of Dora in the K's household is an acting-out.

Acting-out, is essentially something in the behaviour of the subject that shows itself. The demonstrative accent, the orientation towards the Other of every acting-out is something that ought to be highlighted.

In the case of female homosexuality - Freud insists on it - it is before the eyes/bf all, it is in the very measure and all the more when this publicity becomes scandalous, that the behaviour of the

young homosexual is accentuated. And what shows itself, when one advances step by step, shows itself essentially as other, other than it is, what it is nobody knows; but nobody doubts that it is other.

(14) What that is in the case of the young homosexual, Freud says all the same; "She wanted a child from her father", he tells us. But if you were satisfied with that, you are not very hard to please, because this child has nothing to do with a maternal need. That indeed is why, a little earlier, I wanted at least to indicate the problematic of the relationship of the child to the mother. Contrary to a whole slippage in the whole of analytic thought, it is necessary to put the elucidation of unconscious desire in what I might call a sort of lateral relationship with respect to the principal current that has been elaborated.

There is in this normal relationship of the mother to the child, in any case in what we can grasp of it through its economic incidence, something full, something rounded out, something closed, something precisely so complete during the gestatory phase that one can say that we need very special care to make it enter, to see how its incidence is applied to this relationship of cutting between i(o) and o. And after all we only need our analytic experience of the transference and to know at what moment of our analyses our analysands become pregnant and the use this is to them, to know clearly that it is always the rampart of a return to the most profound narcissism.

But let us leave that. It is indeed as something else that the young homosexual wants to have this child. And moreover this thing did not escape, thank God, from Freud: she wanted this child as a phallus, namely, as the doctrine announces it in Freud in the most developed form, as a substitute, Ersatz, for something which falls fully then into our dialectic of the cut and of the lack, of the o as dropped, of the o as lacking. This (15) is what allows her, having failed in the realisation of her desire, to realise it at once differently and in the same way, as eron. She makes herself a lover; in other words, she establishes herself on what she does not have, the phallus, and to show clearly that she has it, she gives it. It is in effect a completely demonstrative way. She behaves, Freud tells us, vis-a-vis the Lady with a capital L, like a servant knight, like a man, as one who can sacrifice for her what he has, his phallus.

Let us combine then these two terms, of showing, of demonstrating, and of desire, no doubt a desire whose essence, whose presence, as you see, is to be, to show oneself, as I told you, as other, and while showing herself as other to still designate herself in this way. In the acting-out, we will say then that desire, in a way, to affirm itself as truth, engages itself along a path on which, no doubt, it only manages to do so in a singular fashion. And we know already by our work here that in a certain way one can say that truth of its nature is not in desire. If we recall the formula that essentially it is not articulatable even though it is articulated, we will be less

astonished by the phenomenon before which we find ourselves. And I gave you a further link: it is articulated objectively since this object that I am designating here, is what I called the last time the object as its cause.

Acting-out essentially is the demonstration, the no doubt veiled showing, but which is only veiled for us as subject, in so far as it speaks, in so far as it could be true, not veiled in itself, on the contrary visible to the maximum degree, and because of that, for that very reason invisible in a certain register. Showing its cause, it is this remainder, it is its collapse, it is what falls into the affair that is the essential of what is shown.

division

0	S	Between the subject here, which is I might say
\$	∅	"othered" (<u>autrifié</u>) in its fictional structure, and the
o		non-authentifiable Other, never completely, what
		emerges is this remainder o, it is the pound of flesh,
		(\$ in 0), which means, I think - you know who I am
		quoting - one can make all the borrowings one wishes to
		plug the holes of desire and of melancholy; there is

here the Jew who, for his part, knows something about balancing accounts and who demands at the end: the pound of flesh.

This is the feature that you always find in acting-out. Remember a point of what I wrote about in my report, "The Direction of the Treatment", where I spoke about the observation of Ernest Kris in connection with the case of plagiarism.

Ernest Kris, because he was on a certain path which we will perhaps have to name, wants to reduce it by means of the truth; he shows him in the most irrefutable fashion that he is not a plagiarist; he has read his book; his book is well and truly original, on the contrary it is the others who have copied him.

The subject cannot contest it. Only he does not give a damn about it. And on leaving, what is he going to do? As you know - I think that there are all the same some people, a majority, who read from time to time what I write - he goes and eats fresh brains.

I am not in the process of recalling the mechanism of the case. I am teaching you to recognise an acting-out and what that means, what I am designating as the small o or the pound of flesh.

With the fresh brains, the patient simply indicates to Ernest Kris; "Everything you tell me is true, simply that does not touch the question; there remain the fresh brains. In order to show (17) you, I am going to eat some when I leave in order to tell you about it the next time".

I am insisting. One cannot, in these matters, go too slowly. You will say to me; what is original in that? You will say to me, after all I am making the demands and giving the answers - I would say, I hope not, but since you could all the same say to me

if I have not sufficiently emphasised it; "What is original in this, this acting-out and this demonstration of this unknown desire? The symptom is the same. Acting-out is a symptom which shows itself as other, and so does it. The proof is that it has to be interpreted". All right then let us dot the i's carefully. You know that the symptom cannot be interpreted directly; that transference is necessary, namely the introduction of the Other. You do not grasp it properly yet perhaps. Then you are going to say to me, "Well yes, this is what you are in the process of telling us about acting-out."

No, what is involved here, is to tell you that it is not essentially in the nature of the symptom to have to be interpreted; it does not call for interpretation like acting-out, contrary to what you might think. Moreover it has to be said; acting-out calls for an interpretation and the question that I am in the process of posing, is that of knowing whether it is possible. I will show you that it is. But it is in the balance in analytic theory and practice.

In the other case, it is clear that it is possible, but on certain conditions which are added to the symptom, namely that transference of its nature should be established; the symptom is not, like acting-out, calling for an interpretation. For - it is too often forgotten - what we discover in the symptom, in its (18) essence, is not, I say, a call to the Other, is not that which shows to the Other, that the symptom in its nature is jouissance - do not forget it - a backhanded jouissance, no doubt, unterbliebende Befriedigung; the symptom does not need you as acting-out does, it is sufficient of itself; it is of the order of what I have taught you to distinguish from desire as being jouissance, namely that it goes, for its part, towards the Thing, having passed the barrier of the good (a reference to my seminar on Ethics), namely of the pleasure principle, and this is why this jouissance can express itself by an Unlust.

I am not the only one who is either inventing or articulating all of this, it is said in these very terms in Freud; Unlust, unpleasure, for those who have not yet heard this term, in German.

So then let us return to acting-out, as opposed to the symptom, acting-out for its part is the beginning of transference. It is wild transference. There is no need for analysis - as you no doubt know - for there to be transference. But transference without analysis is acting-out, acting-out in analysis is transference. The result is that one of the questions to be posed, is, concerning the organisation of transference - I mean the organisation, the Handlung of transference - that one of the ways of posing the question is to ask how one can domesticate the wild transference, how one gets the wild elephant into the enclosure or how one can get the horse into the ring, where one makes him turn round, in the circus.

It is one of the ways of posing the problem of transference which

it would be quite useful to pose from this angle, because it is the only way of knowing how to deal with acting-out.

(19) For people who may have to interest themselves in the near future in acting-out, I note the existence, in the Psychoanalytic Quarterly, of the article by Phyllis Greenacre; "General Problems of Acting-Out". It is in Number IV of Volume 19 of 1950, so it is not impossible to find. It is a very interesting article in many ways, and evokes a memory for me: it was at the time about ten years ago when we had already received a visit from some investigators. Phyllis Greenacre, who was one of them, gave me the opportunity to observe a lovely acting-out, namely the frenetic masturbation, which she carried out before my eyes, of a little Japanese mussel fisherman, which I owned and which still carries the traces of it, I mean this object does. I have to say that this furnished the opportunity for a very agreeable conversation, much better than the one punctuated by different passages a l'acte, for example her jumps almost to the ceiling, which I had with the lady.

Therefore this article on "General problems of acting-out", in which there are very pertinent remarks, even though as those of you who read it will see, they gain by being illuminated by the original lines that I am trying to sketch before you.

The question then is to know how to deal with acting-out. There are three of them, she says. There is interpreting it, there is prohibiting it, there is reinforcing the ego.

You should not have any great illusions about interpreting it. Phyllis Greenacre is a very very able woman. Interpreting it, after what I have just told you, promises to have very little effect, as I might say, if only because this is why the acting-out is done. When you look at things closely, most of the time (20) you see that the subject knows very well that what he is doing, is done to offer himself to your interpretation by acting-out. Only you see, it is not the meaning of what you interpret that counts, whatever it may be; it is the remainder. So that this time at least, without something more, it is an impasse. It is very interesting to spend some time scanning the hypotheses.

To prohibit it, naturally that even makes the author herself smile when she says: all the same, one can do many things, but to say to a subject, "No acting-out", is something which is all the same difficult. Besides nobody dreams of doing it. All the same, in this connection, one observes the amount of prejudicial prohibition there is in analysis. Many things obviously are done to avoid acting-out in the session. Then one tells them not to take **decisions** that are essential for their existence during the analysis. Why does one do all of this? Indeed it is a fact that wherever one has a hold, has a certain relationship with what one can call danger either for the subject, or for the analyst.

In fact one prohibits much more than one believes. If I say - which I would be quite willing to illustrate - what I have just said, it is because essentially, and because we are doctors, and because we are good, as someone or other has said, one does not want the patient who has come to entrust himself to us to hurt himself. And the funny thing is that one manages it.

Acting-out is the sign all the same that one is preventing a lot of things. Is this what is involved, when Mrs Greenacre speaks about allowing a more solid transference to be established? What I would like to remark on here, is that a certain aspect of analysis that is not seen is its accident-insurance, sickness-insurance aspect; because it is very funny all the same how much (21) at least from the moment that an analyst has taken on that experience that is called, namely all that he most often ignores in his own attitude, the degree to which short-term illnesses are rare during analyses, the degree to which, in an analysis which lasts for a certain time, colds, flues, all of that is effaced, and even long-term illnesses; indeed, if there were more analyses in society, I think that social insurance, as well as life insurance, would have to take the proportion of analyses in the population into account in order to modify their rates.

Inversely, when an accident happens - an accident, I am not speaking dimply about acting-out - it is very regularly attributed by the patient and by his entourage to the analysis, it is in a way naturally attributed to the analysis. They are right; it is an acting-out, therefore it is addressed to the Other. And if one is an analyst, it is therefore addressed to the analyst. If he has taken up this place, so much the worse for him. He has all the same the responsibility which belongs to this place which he has agreed to occupy.

These questions are designed perhaps to clarify for you what I mean when I speak about the desire of the analyst and when I question it. Without dwelling for a moment on the question which changes the question of the way in which we domesticate the transference - for you see that I am in the process of saying that it is not simple without stopping for a moment to say what it is I am always opposed to, namely that what is involved here is reinforcing the ego - because on the admission even of those who are engaged along this path for more than a decade and more exactly for so many decades that people are beginning to speak less about it nowadays, this can only mean, as we see in the (22) literature, leading the subject to the identification, not at all with this image as a reflection of the ideal ego in the Other, but to the ego of the analyst with the result that Balint describes for us, the really manic terminal crisis that he describes for us as being that of the end of an analysis characterised in this way, and which represents the insurrection of the o which has remained absolutely untouched.

Let us return then to Freud and to the observation of the case of female homosexuality, in connection with which we have all sorts of quite admirable notations, because at the same time as he

tells us that he is quite clear that there is no hint here of something called transference being produced, he says at the same time, and at this time and in this case which designates some blind spot or other in his position, he says all the same that there is no question of stopping for an instant at the hypothesis that there is no transference.

This is to fail to recognise what is involved in the transference relationship. We find it expressly formulated in this discourse of Freud about his case of female homosexuality. It nonetheless remains that Freud, the day he had a patient who - the thing is articulated as such - who lied to him in a dream, for this is how Freud characterises the case, the agalma, what is precious in this discourse on female homosexuality, is that Freud stops for a moment, flabbergasted, before the following - he also makes demands and gives the answers - he says, "What is happening here, the unconscious can lie?", for the dreams, as you know, of this patient, mark every day greater and greater progress towards the sex to which she is destined. Freud does not believe it for a single moment - and with good reason! - for the patient who brings him her dreams tells him at the same time: "But, yes of course, this will allow me to marry, and allow me at the same (14) time to occupy myself all the more with women". Therefore, she herself is telling him that she is lying. And moreover Freud has no doubt about it. It is precisely the absence of any appearance of the transference relationship. But what does he pause at then, this unconscious that we are used to considering as being the most profound, the truly true? It then can deceive us. And it is around this that the whole debate turns, it is around this Zutrauen, of this trust we should have: can we still preserve it, he says.

He affirms it in a sentence which is very characteristic because it is so elliptical and concentrated, that is has this character almost of stumbling over words; what is really involved - I will read the sentence again for you, I did not bring it with me, I will bring it the next time, it is really very lovely - it is still a question of a squabble.

This unconscious still deserves trust. The discourse of the dream, he tells us, is not the same thing as the unconscious; it is constructed by a desire coming from the unconscious, but he admits at the same time that it is this desire that is expressed, to the point of formulating it: it must be then that the desire comes from something, and coming from the unconscious, and it is this desire which is expressed through lies.

She tells him herself that her dreams are lying. What Freud pauses at, is the problem of any symptomatic lie. You see what a lie is for a child is what the subject means by lying. The strange thing, is that Freud lets things drop in the face of this seizing up of the whole machine; he does not interest himself precisely in what makes it seize up, namely the waste scraps, the little remainder, what has brought everything to a halt and what is here that comes into question.

Without seeing what he is embarrassed by, he is undoubtedly moved, as he shows, by this threat to the fidelity of the unconscious, he goes into action (passee a.l 'acte) . It is the point at which Freud refuses to see the structure of fiction at the origin of the truth, which is his passion.

This is where he has not sufficiently meditated on what, speaking about the phantasy, I emphasised before you in a recent discourse on the paradox of Epimenides, on the "I am lying" and its complete acceptability, in so far as what lies is desire in the moment that affirming itself as desire it delivers the subject to this logical cancelling-out on which the philosopher pauses, when he sees the contradiction of "I am lying".

But after all what Freud is missing, as we know, is what he is missing in his discourse. It is what has always remained as a question for him as a question: "What does a woman want?". The stumbling of Freud's thinking upon something that we can call provisionally - do not make me say that woman as such is a liar, but that femininity conceals itself and that there is something of that angle there.

To employ the terms of liquid, it is that flowing sweetness, something before which Freud almost died of suffocation because of a nocturnal stroll taken by his fiancée, the very day that they exchanged the two final vows, with a vague cousin, I no longer remember very well, I did not look up the biography, I call him a vague cousin, it is some indifferent person, it is one of these young gallants who have as they say an assured future, which means that they do not have any - with whom he had discovered a little later that she had taken a little stroll, and this is where the blind spot is: Freud wants her to tell him everything. The woman did indeed do her talking cure, and as regards chimney sweeping she was well swept!

(25) For some time, people have not been stubborn about it; the important thing is to be together in the same chimney. The question, when you emerge - as you know, it was recalled at the end of one of my articles, borrowed from the Talmud - when you emerge together from a chimney, which of the two is going to wash his face? Yes, I advise you to re-read this article, and not alone that one, but also the one that I wrote on "The Freudian thing". The Freudian thing - you can see designated there, with a certain amount of emphasis I might say - is this Diana that I designate as showing the continuation of this hunt which continues. The Freudian thing, is what Freud let drop, but it is still what leads, in the shape of all of us, the whole hunt after his death. We will continue this pursuit the next time.

Seminar 10: Wednesday 30 January 1963

Anxiety, we have always been taught, is a fear without an object. A chant in which, we could say here, another discourse already announces itself, a chant which however scientific it may be is close to that of the child who reassures himself. For the truth that I am enunciating for you, I formulate in the following way: "It is not without an object". Which is not to say that this object is accessible along the same path as all the others. At the time I said it, I underlined that it would be another way of ridding oneself of anxiety to say that a homologous discourse, similar to every other part of scientific discourse, could symbolise this object, put us in that relationship of symbol with it to which, in this connection, we are going to return.

Anxiety sustains this relationship of not being without an object subject to the reservation that this is not to say nor to be able to say, as we could for something different, what object is involved.

In other words, anxiety introduces us with the accent of maximal communicability to the function of lack, in so far as it is radical for our field. This relationship to lack is so fundamental for the constitution of any logic and in such a way that one can say that the history of logic is that of its success in masking it, which means that it appears to be akin to a sort of vast parapraxis, if we give to this term its positive sense.

This indeed is why you see me, along one path, always coming back to these paradoxes of logic which are designed to suggest to you the paths, the ways in, by which there is regulated, there is imposed on us the certain style by which we are able for our part (2) to succeed with this parapraxis: not to miss the lack (ne pas manquer au manque).

That is why I thought once more of introducing my discourse today by something which of course is only an apologue, and on which you cannot base yourself on any analogy properly speaking in order to find in it what might be the support for situating this lack, but which nevertheless is useful in order to reopen in a way this dimension which in a way every discourse, every discourse of analytic literature itself, gives you, in the intervals, I would say, of the one in which here from week to week, I catch up with you, necessarily to rediscover the hinge of something which might close in our experience, and, by whatever

gap it intends to designate this lack, would find in it something that this discourse could fill.

The little apologue then, the first one that came to me. There could be others, and after all, all I want to do here is to go quickly. I told you in short at one time that there is no lack in the real; the lack is only graspable through the mediation of the symbolic. It is at the level of the library, one might say: here such a volume is not in its place (manque a sa place), this place which is a place designated already by the introduction, into the real, of the symbolic. And here, this lack here that I am speaking about, this lack which the symbol in a way easily fills, designates the place, designates the absence, presentifies what is not there. But notice that the volume in question carries on the first page - a volume which I acquired this week, and this is what inspired this little apologue - carries on the first page the notation: "the four engravings from such and such to such and such are missing". Does this mean, in accordance with the function of the double negation, that because the volume is not in its place, the lack of these four engravings is (3) removed, that the engravings come back to it. Clearly, there is no question of it.

This may appear a bit stupid to you, but I would point out to you that here we have the whole question of logic, of logic transposed into these intuitive terms of the Eulerian schema, of the included lack. What is the position of the family in the genus, of the individual in the species, what constitutes a hole within a plane circle?

If I made you do so much topology last year, it was indeed to suggest to you that the function of the hole is not univocal. And this indeed is how you must understand that there is always introduced along this path of thinking that we describe in different forms as metaphorical in different forms, but always indeed being referred to something, this planification, this implication of the very simple plane as constituting fundamentally the intuitive support of the surface. Now this relationship to the surface is infinitely more complex; and of course by simply introducing to you the ring, the torus, you are able to see that it is enough to elaborate what is in appearance the most simple surface to imagine, to see there being diversified, on condition that we consider it indeed as it is, as a surface, to see there being diversified strangely there the function of the hole.



I point out to you once again how it is to be understood; because everything that is in effect to be known, how a hole can be filled, can be completed, we will see that no circle whatsoever drawn on this surface of the hole is able - for this is the problem - to constrict itself to the stage of being nothing but this vanishing limit, the point, and of disappearing.

(4) For of course there are holes which can, on which we can

operate in this way, and it is enough for us to draw our circle in the following way - if I draw it, it is in order not to express myself otherwise - or in that way to see that they cannot reduce themselves to zero. There are structures which do not involve the filling of the hole

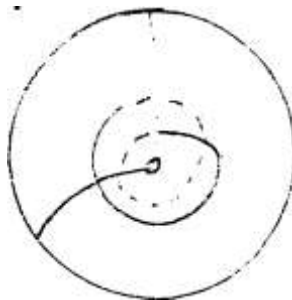

The essence of the cross-cap, as I showed it to you last year is the following: it is that apparently whatever cut you draw on the surface - I will not spend any more time on it, I would ask you to test it out for yourselves - we will not have apparently this diversity; if we draw this cut in this way, which is homologous at the level of the cross-cap to the cut which on the torus is repeated as follows, namely which partakes of two other types of circle, which reunites them in itself, the two first that I have just drawn, if you draw them here on the cross-cap in this way, if you draw this cut, passing in this way through this privileged point to which I drew your attention last year, you will always have something which in appearance will be always able to be reduced to the minimal surface, but not without - as I pointed out to you - there remaining at the end - I repeat - whatever the sort of cut, there remaining at the end only something which is symbolised not like a concentric reduction, but irreducibly in this shape or in that one which is the same, and that one cannot as such not differentiate from I what I earlier called concentric (5) punctualisation.

It is in this that the cross-cap was for us another contributing path in what concerns the possibility of an irreducible type of lack. The lack is radical. It is radical for the very constitution of subjectivity, as it appears to us on the path of analytical experience. Which, if you wish, I would like to enunciate in this formula: "Once it is known, once something of the Real comes to be known, there is something lost; and the surest way to approach this something lost, is to conceive of it as a fragment of the body".

Here is the truth which in this opaque, gross form is the one that analytic experience gives us, and which it introduces with its irreducible character into any reflection henceforth possible on any conceivable form of our condition. This point, it must be clearly said, involves enough of the intolerable for us to ceaselessly try to distort it, which has no doubt two aspects, namely that in this very effort we are doing more than sketching out its outlines and that we are always tempted, in the very measure that we approach this outline, to forget it in function of the very structure that this lack represents.

Whence it results, another truth, that we could say that every turn of our experience rests on the fact that the relationship to the Other, in so far as it is that in which there is situated every possibility of symbolisation and the locus of discourse, is connected with a structural flaw, and that we are obliged - this is the further step - to conceive that we are touching here on what makes possible this relationship to the Other, namely this point from which it emerges that there is signifier (du signifiant), is the one which in a way cannot be signified. This (6) is what is meant by what I call the "lack of signifier" point.

And recently, I heard someone who does not understand me too badly at all, responding to me, questioning me, whether this does not mean that we refer ourselves to that which in any signifier is in a way the imaginary material, the shape of the word or that of the Chinese character, if you wish, what is irreducible in the fact that it is necessary that every signifier should have an intuitive support like the others, like all the rest.

Well, precisely not. For of course, this is the temptation that arises in this connection. This is not what is involved as regards this lack. And in order to make you sense it, I will refer to definitions which I have already given you and which ought to be enough. I told you: "There is no lack which is not of the symbolic order. But privation, for its part, is something real." What we are speaking about is something real; what my discourse turns around, when I try to represent for you this decisive point, which nevertheless we always forget, not only in our theory, but in our practice of analytic experience, is a privation which manifests itself as much in the theory as in the practice, it is a real privation and which as such can be reduced. Is it enough to designate it in order to remove it? If we manage to circumscribe it scientifically - which is perfectly conceivable - it is enough to work over the analytic literature, an example of which I will give you in a little while, namely a sample, to begin with - there is no other way of doing this - I took the first volume of the International Journal which came to hand and I will show you that almost everywhere we find the problem involved: whether one speaks about anxiety, about acting-out or about - since it is the title of the article to (7) which I will allude later - about R - I am not the only one who makes use of letters - the total response. The total response of the analyst in the analytic situation, by someone whom it happens we rediscover, of whom I spoke in the second year of my seminar, Margaret Little by name, we will find this problem very well centred and we can define it: where is the privation situated, where obviously does she slip up in the measure that she attempts to get closer and closer to the problem that a certain type of patient poses for her? It is not this, the reduction, the privation, the symbolisation, its articulation here which will remove the lack. This is what we have to keep clearly in mind from the start, and if it is only to understand what is signified from one point of view by a mode of appearance of this lack: as I told you, privation is something real. It is

clear that a woman does not have a penis. But if you do not symbolise the penis as the essential element to have or not to have, she will know nothing of this privation. Lack for its part is symbolic.

Castration appears in the course of analysis, in so far as this relationship with the Other, which moreover did not wait for analysis to be constituted, is fundamental. Castration, as I told you, is symbolic, namely it refers to a certain phenomenon of lack, and at the level of this symbolisation, namely, in the relationship to the Other, in so far as the subject has to constitute himself in the analytic discourse. One of the possible forms of the appearance of the lack is here the (-⊙), the original support which is only one of the possible ^ expressions of the original lack, of the structural flaw inscribed in the being in the world of the subject with whom we (8) have to deal. And in these conditions it is conceivable, normal to ask oneself why, by bringing analytic experience to a certain point - and not beyond - this term of castration complex, that Freud gives us as final in the man, he tells us, and of Penisneid in the woman, can be put in question. It is not necessary that it should be final.

This indeed is why it is an essential approach in our experience to conceive of this function of lack in its original structure. And it is necessary to come back to it many times in order not to miss it.

Another fable: the insect who moves along the surface of the Moebius strip - I have now I think spoken enough about it for you to know immediately what I mean - this insect can believe that at every moment, if this insect has the representation of what a surface is, there is a face, the one always on the reverse side of the one on which he is moving, that he has not explored. He can believe in this reverse side. Now as you know there is not one. He, without knowing it, explores what is not the two faces, explores the single face that is there: and nevertheless at every instant, there is indeed a reverse. What he lacks in order to perceive that he has gone to the reverse side, is the little missing piece, the one outlined for you in this way of cutting the cross-cap and that one day I materialised, to put it in your hands, constructed, this missing little piece. It is a way of turning here in a short circuit around the point which brings it back by the shortest path to the reverse side of the point where he was the instant before.

This little missing piece, the o as it happens, does this mean, because we are describing it there in a paradigmatic form, that the affair is resolved for all that? Absolutely not, since it is (9) the fact that this piece is missing, that gives all its reality to the world around which the little insect is moving.

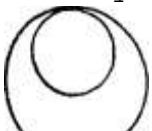
The little interior eight is well and truly irreducible: it is a lack for which the symbol does not supply. It is not then in the first place, an absence which the symbol can make up for.

Nor is it a cancellation or a *dénégation*; for cancellation and *dénégation*, forms constituted from the relationship that the symbol allows to be introduced into the real, namely the definition of absence, cancellation and *dénégation* is an attempt to undo that which in the signifier separates us from the origin and from this structural flaw. It is an attempt to rejoin its sign function; it is what the obsessional, for all that, strives and exhausts himself for. Cancellation and *dénégation* aim then at this point of lack, but do not rejoin it for all that; because as Freud explains, all they do is to duplicate the function of the signifier in applying it to themselves, and the more I say it is not that, the more it is that.

The spot of blood, intellectual or not, whether it is the one that Lady Macbeth exhausts herself with or what Lautréamont designates under the term "intellectual", is impossible to efface because it is the nature of the signifier precisely to strive to efface a trace. And the more one tries to efface it, to rediscover the trace, the more the trace insists as signifier.

Whence it results that we have to deal, as regards the relationship to the fact that the little o manifests itself as cause of desire, with an always ambiguous problematic. In effect



when it is inscribed in our schema, which is always to be renewed, there are two ways in which the relationship of the Other to the small o can appear.

(10) If we can rejoin them, it is precisely by the function

of anxiety, in so far as anxiety, wherever it is produced, is the signal of it and there is no other way of being able to interpret what is said to us in analytic literature about anxiety.

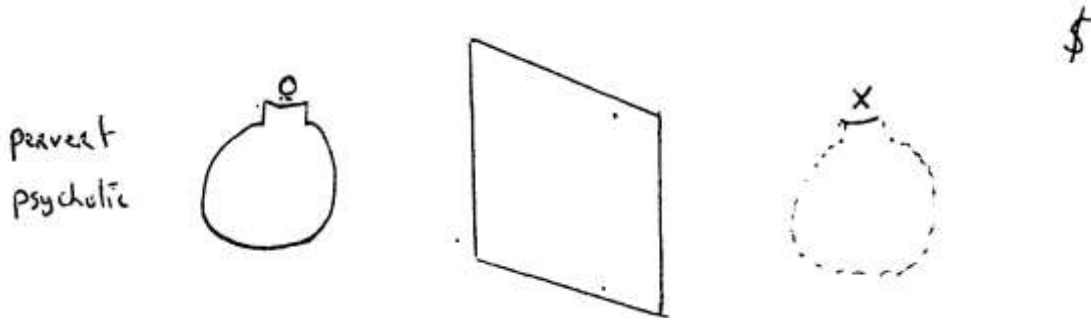

Because after all notice how strange it is to bring together these two aspects of analytic discourse: on the one hand that anxiety is the greatest, most radical defence and that it is necessary here for the discourse about it to be divided into two references: 1) one to the real in so far as anxiety is the response to the most original danger, to the unsurmountable *Hilflosigkeit*, to the absolute distress of entering into the world and that 2) on the other hand, it is going to be able to be subsequently taken up by the ego as a signal of infinitely slighter dangers, of dangers, as we are told somewhere by Jones,

who on this point shows a tact and a measure which is often greatly lacking in the bombast of analytic discourse, about what he calls the threats of the Id, of the *fa*, of the *Es*, which Jones simply calls a "buried desire", un desir enterre. As he remarks, is this return of a buried desire so dangerous after all, and does this merit the mobilisation of such a major signal as this ultimate, final signal which anxiety is supposed to be, if in order to explain it we are obliged to have recourse to the most absolute vital danger.

(11) And this paradox is found again a little further on. For there is no analytic discourse which, after having made of anxiety the final element of every defence, does not speak to us about defence against anxiety. So that this instrument which is so useful for warning us about danger, is the very one that we have to defend ourselves against; and it is in this way that one explains all sorts of reactions, of constructions, of formations, in the field of psychopathology. Is there not some paradox here which requires things to be formulated differently, namely that the defence is not against anxiety, but against that of which anxiety is the signal and that what is involved is not defence against anxiety, but against a certain lack, except for the fact that we know that there are different structures, definable as such, of this lack, that the lack of the single edge, which is that of the relationship with the narcissistic image, is not the same as that of the double edge which I am speaking to you about, and which is referred to the least extreme cut and to the one which concerns the *o* as such, in so far as it appears, as it manifests itself, that it is with it, that we have, that we can, that we ought to be dealing, at a certain level of the handling of the transference.

Here there will appear, it seems to me, better than elsewhere that the lack of handling is not the handling of the lack and that what needs to be picked out is what you always find every time a discourse is pushed far enough about the relationship that we have as Other to the one that we have in analysis, that the question is posed as to what our relationship with this *o* ought to be.

There is an obvious gap between the permanent, profound putting in question which the analytic experience in itself is supposed to be, always referring the subject on to something different

(12) to what he manifests to us whatever its nature may be. Transference is only, as one of my women patients said to me not long ago: "If I was sure that it was only transference". The function of the "only (ne que): "it is only transference" the reverse side of "He has only to do it in this way", this form of the verb which is conjugated, but not, as you believe, the one which makes one say: "II n'a qu'avait", that one sees flowering spontaneously in a spontaneous discourse.

It is the other aspect of what is explained to us as being, it seems, the charge, the burden of the hero analyst of having to interiorise this *o*, to take it into himself, as a good or bad

object, but as an internal object and that it is from there that there is supposed to emerge all the creativity through which he ought to restore the subject's access to the world.

Both things are true, even though they are not connected: it is precisely for this reason that they are confused and that by confusing them, nothing clear is said about what concerns the handling of this transferential relationship, the one which turns around the o. But it is this that is sufficiently explained by the remark that I made to you, that what distinguishes the position of the subject with respect to o, and the very constitution as such of his desire, is, to say things in a summary fashion, that whether we are dealing with a pervert or a psychotic, the relationship of the phantasy \$O o is established in this way (Schema p 6), and it is here that in order to handle the transferential relationship we have in effect to take into ourselves like a foreign body, an incorporation of which we are the patient, the o in question, namely the object which is absolutely foreign to the subject who is speaking to us, in so far as it is the cause of his lack.

In the case of neurosis, the position is different in so far as - as I told you - something appears here which distinguishes the function of the phantasy in the neurotic. Here there appears (13) at X something of his phantasy which is an o, and which only appears so (le parait). And which only appears so because this little o is not specularisable and cannot appear here, as



I might

say, in person, but only as a substitute. And it is only there that there is applied the profound questioning of any authenticity in the classical analysis of transference.

But this is not to say that we have here the cause of transference, and we have to deal with this little o which, for its part, is not on the stage, but which only asks at every instant to be allowed to mount it to introduce its discourse there, even if this were to sow, in the one who continues to *ho!* the stage, to sow confusion, disorder, to say: "Stop the tragedy", just as much as "Stop the comedy", even though this is a little better. There is no drama. Why does Ajax get himself into such a stew, as they say, when after all if all he did was to exterminate the sheep that is so much the better? It is all the same less serious than if he had exterminated all the Greeks since he did not exterminate all the Greeks, he is all the less dishonoured; and if he indulges in this ridiculous manifestation everyone knows it is because Minerva cast a spell on him.

Comedy is less easy to exorcise. As everyone knows, it is more gay, and even if one exorcises it, what happens on the stage can very easily continue; one begins again at the song of the billygoat's foot, at the true history of what is involved from the beginning, at the origin of desire. And this is the reason why moreover tragedy bears in itself, in its term, in its name, its designation, this reference to the billygoat and the satyr, (14) whose place moreover was always reserved at the end of a

trilogy.

The billygoat who jumps onto the stage, is what acting-out is. And the acting-out I am speaking about, namely the inverse movement of what modern theatre aspires to, namely that the actors go down among the audience: it is the spectators who mount the stage and say there what they have to say.

And this is why someone like Margaret Little, chosen from among others - and as I told you - really in the way that one blindfolds oneself and lays out pages to make a divination by spinning a knife.

Margaret Little, in her article on "The analyst's total response to his patient's needs", of May-August 1957, Parts III-IV of Volume 38 of the International Journal of Psychoanalysis, pursues the discourse that I already dwelt on at a point in my seminar when this article had not yet appeared. Those who were there will remember the remarks that I made, about a certain anxiety-ridden discourse on her part and her attempts to master it in connection with counter-transference. They no doubt remember that I did not stop at the first appearance of the problem, namely the effects of an inexact interpretation, namely that one day an analyst says to one of his patients who comes back from having made a broadcast, a broadcast on a subject which interests the analyst himself - we see more or less the milieu in which this could have happened: "You spoke very well yesterday, but I see you are very depressed today; it is surely because of the fear you have of having hurt me by invading an area that I am interested in". Two years have to pass before the subject perceives, in connection with the return of an anniversary, that what had caused him to be so sad was linked to the feeling he (15) had, having made this broadcast, of having revived in himself the feeling of mourning that he had about the recent death of his mother who, he says, could therefore not see success represented for her son at being in this way momentarily promoted to the position of a star.

Margaret Little is struck, because it is a patient that she had taken on from this analyst, by the fact that effectively the analyst in making his interpretation had done no more than interpret what was passing through his own unconscious, namely that effectively he was very sorry at the success of his patient.

What is involved nevertheless is something quite different, namely that it is not enough to talk about mourning and even to see the repetition of the mourning that the subject was suffering at that time, the one that two years later he was having for his analyst, but to see what is involved in the function of mourning itself and here at the same time to take a little further what Freud tells us about mourning as identification with the lost object. It is not an adequate definition of mourning. We are only in mourning about someone of whom we can say "I was his lack (j'etais son manque)". We mourn people that we have either well or badly treated and vis-a-vis whom we do not know whether we

fulfill this function of being at the place of their lack.

What we give in love, is essentially what we do not have and, when what we do not have returns to us, there is undoubtedly a regression and at the same time a revelation of the way in which we have failed the person (manque a la personne) in representing his lack.

But here, because of the irreducible character of the miscognition concerning the lack, this miscognition simply is reversed, namely that this function that we had of being his lack, we now believe we are able to express in the fact that we (16) have been lacking to him, even though it was precisely for this reason that we were precious and indispensable to him.

Here is what I would ask you: if it is possible, pick out this and a certain number of other reference points, if you are willing to work at it, in Margaret Little's article. It is a further phase of reflection which is considerably deeper, if not better. Because it is not better. The very problematic definition of counter-transference is absolutely not advanced and I would say up to a certain point that we can be grateful to her; because if she had advanced into it, it would have been mathematically, into error. All she wants - as you will see - to consider from then on is the total response of the analyst, namely just as much the fact that he is there as analyst as the things which, for him the analyst, as this present example shows, can escape from his own unconscious, as the fact that like every other living being she experiences feelings in the course of analysis, and that after all she does not say it like that, but this is what is involved: being the Other, she is in the position that I told you about the last time, namely from the beginning one of entire responsibility.

It is therefore with this class, this "immense total", as she says, of her position as analyst, that she intends to respond before us and respond honestly about what she conceives to be the response of the analyst. The result is that she goes as far as to take the most contrary positions - that does not mean that they are false - to the classical formulations, namely that far from remaining outside the game, the analyst must suppose in principle that he is involved up to the hilt, consider himself on occasion effectively as responsible and in any case, never (17) refuse to testify, if concerning what happens in the analysis she is for example summoned, by her subject, to answer before a court of law.

I am not saying here that this attitude can be sustained, I am saying that to evoke it, to place within this perspective the function of the analyst is something which undoubtedly will appear to you of an originality which gives rise to problems, that the feelings - I mean all the feelings of the analyst - can be in some cases summoned, as I might say, to justify themselves, not only at the tribunal of the analyst himself - which everyone will admit - but even with respect to the subject, and that the

weight of all the feelings that the analyst may experience with regard to one or other subject who is engaged with him in the analytic enterprise, can be not alone invoked, but be promoted into something which will be not an interpretation, but an avowal, entering in this way on a path whose first introduction into analysis by Ferenczi was the object on the part of classical analysts of the most extreme reservations.

Undoubtedly, our author divides the patients with whom she is dealing into three parts. Since she seems to admit a very large range of cases under her charge, we have on the one hand the psychoses, for whom it is necessary that she should admit that, if only for the hospitalisation that is sometimes necessary, it is necessary for her to discharge a part of her responsibilities onto other supports; the neuroses, of which she tells us that the greatest share of responsibility of which we discharge ourselves also in neuroses, is put on the subject's shoulders - giving proof of remarkable lucidity -; but, between the two, the subjects she defines as the third class, character neuroses or reactional personalities, whatever you like, what Alexander defines again as "neurotic characters", in short this whole area around which there are developed such problematic indications or classifications, while in reality it is not a kind of subject that is involved, but a zone of relationship, the one that I am defining here as acting-out. And it is indeed in effect what is involved, in the case that she is going to develop for us, which is the case of a subject who has come to her because she performs acts which are classed within the frame of kleptomania, who for a year moreover does not make the slightest allusion to these thefts, and who goes through a whole long time of analysis, under the total and vigorous fire on the part of our analyst, of the most repeated here-and-now transference interpretations in the sense taken nowadays, along the path generally adopted, as that which ought to be from a certain moment staunched, sponged up ceaselessly right through the analysis.

None of these interpretations, however subtle and varied she makes them, touch for an instant the defence of her subject. If someone - I am going to end with this - would be willing to do me the service, at a date that we are going to fix, of entering into the detailed exposition of this case, of doing this thing that I cannot do before you because it is too long and because I have other things to tell you, you will see, in all its details, there being manifested the relevance of remarks that I am in the process of making to you now.

The analysis only begins to move, she tells us, at the moment that one day her patient came with her face swollen with weeping, and the tears that she is weeping about the loss, the death, in a country that she had left a long time before with her parents, namely the Germany of that time, Nazi Germany, of a person who was not distinguished among those who had looked after her during her childhood, except that she was a friend of her parents and no (19) doubt a friend with whom she had very different relationships than her relationships with her parents; for it is

a fact that she never showed such mourning for anyone else (247).

Before this passionate, surprising reaction, what is the reaction of our analyst? Undoubtedly one of interpreting as one always does. She varies them again, as a way of seeing which one will work. The classic interpretation, namely that this mourning is a need for retortion against the object, that this mourning is perhaps addressed to her, the analyst, that it is a way, using the person that she is mourning for as a screen, of bringing to her, the analyst all the reproaches that she has against her. Nothing works.

Something begins to be freed up when the analyst - literally - as you will see, it is very visible in the text - admits before the subject that she is completely confused and that to see her like that was painful to the analyst herself. And immediately our analyst deduces that it is the positive, the real, the living element of a feeling which gave its movement to the analysis. The whole text bears sufficient witness to it, the subject chosen, the style as well as the order of its development, for us to be able to say what is involved and what undoubtedly touches the subject, what makes it possible for her, which allows her to transfer properly speaking in her relationship to the analyst the reaction involved in this mourning, namely the appearance of the following, that there was a person for whom she was able to be a lack: the fact is that the intervention of the analyst makes there appear to her - in the analyst - this thing which is called anxiety. It is in function of where we are at the limit of something which designates in the analysis the place of the lack that this insertion, that this graft, as I might say, this (20) layering which allows a subject whose whole relationship with her parents is defined - you will see in the observation that in no relationship was this female subject able to grasp herself as a lack - to find here a way to open up.

It is not qua positive feeling that the interpretation - if one can call it that, because it is well described for us in the observation: the subject drops her arms and gives up - at this place, that this "interpretation", if one can describe it as such, reached, it is as an introduction in an involuntary way of something that is in question and that always ought to come into question at whatever point it may be, even if it is at the end, in the analysis, namely the function of the cut. And what is going to allow you to locate it, to designate it, is that the turning points - the decisive ones of the analysis - are two moments: the moment that the analyst taking courage in the name of the ideology of life, of the real, of anything you wish, makes all the same the most unusual intervention, to be situated as decisive with respect to this perspective that I would call sentimental; one fine day when the subject was going over again all her stories about money quarrels - if I remember correctly, with her mother, she ceaselessly comes back to it - the analyst says to her in the clearest terms: "Listen! Stop that, because literally I can no longer listen to it! You are sending me to sleep". (248)

The second time - I am not giving you this as a model of technique, I am asking you to follow the problems which are posed for an analyst who is obviously as experienced as she is burning with authenticity - the second time, it involved slight modifications which had been carried out in the analyst's house, what she calls the redecoration of her office - if we are to go (21) on the average redecoration carried out by our colleagues, it must have been lovely - already our Margaret Little had been pestered all day by the remarks of her patients: "It's nice, it's not nice, the brown is disgusting, that green is lovely...": and now here is our patient who starts again towards the end of the day, she tells us, and puts that in terms that are, let us say, a little bit more aggressive than the others, and she says to her textually: "I really don't care what you think about it". (248)

The patient, I have to say, like the first time, is profoundly shocked, astounded. After which she emerges from her silence with enthusiastic cries: "Everything you have done there is marvellous". I will spare you the details of the progress of this analysis. What I would simply like to designate here, is that in connection with this case which is favourable and, if you wish, chosen in a part of the field particularly favourable to this problematic, what is decisive in this factor of progress which consists essentially in introducing the function of the cut, is in so far as she tells her in her first interpretation the following: "You're leaving me out of it completely: you are sending me to sleep", and in the other case she literally puts her in her place: "You can think what you want about my decoration, of my office. I don't care about it in the slightest!", that something decisive was mobilised in the transference relationship that is in question here.

This allows us to designate what is involved for the subject. The problem for her, one of her problems is that she had never been able to produce the slightest feeling of mourning for a father whom she admired. But the stories - as you will see - which are reported to us, show us that, if there is something over-emphasised in her relationships with her father, it was well and (22) truly that in any case there was no question in his regard of representing in any way something which could be, from whatever angle it was taken, being lacking to her father.

There was a little stroll with him and a very significant scene about with a little stick quite symbolic of the penis, because the patient herself underlines it and it seems in a rather innocent way - the father throws this little stick into the water without making any comment on it. This story is not the same as the dimanches de Ville d'Avray.

And as regards the mother, the one who is involved in the closest fashion in determining the thefts, this because undoubtedly she has never been able to make of this child anything other than a sort of prolongation of herself, a piece of furniture, an instrument of menace and blackmail on occasion, but in no case something which with respect to her own desire, the desire of the

subject, could have been a causal relationship.

It is to designate the following, namely that her desire - she does not know which one of course - could be taken into consideration, that each time the mother approaches, enters into the field of induction where she can have some effect, the subject very regularly steals something, a theft which like all the thefts of the kleptomaniac has only a signification of particular interest which means simply: "I am showing you an object that I stole by force or by cleverness and which means that there is somewhere another object, my one, the o, the one which deserves to be considered, to be allowed to isolate itself for a moment". This function of isolation, of being alone (etre-seul) has the closest relationship, is in a way the correlative (23) pole of this function of anxiety as you will see in what follows. "Life", we are told somewhere by someone who is not an analyst, Etienne Gilson, "existence is an uninterrupted power of active separations".

I think that you will not confuse, after today's discourse, this remark with the one which is usually made about frustrations. Something else is involved. What is involved is the frontier, the limit where the place of the lack is established.

A continuous, I mean varied reflection about the different, metonymical forms in which there appear in clinical practice the focal points of this lack, will constitute the continuation of our discourse. But we cannot but treat it ceaselessly along with the putting into question of what one can call the goals of analysis. The positions taken up in this respect are so instructive, educative that I would like at the point that we are at, that besides this article to which it would be appropriate to return, to follow it in detail, you should read another article by someone called Szasz on the goals of analytic treatment, "On the theory of psychoanalytic treatment", in which you will see that there is advanced the following: it is that the aims of analysis are given by its rule. And that its rule, and at the same time its aims can only be defined as promoting as a final goal of analysis, of every analysis whether it is didactic or not, the initiation of the patient into a scientific point of view - that is how the author expresses himself - concerning his own movements.

Is that a definition? I am not saying that we can accept it or reject it, it is one of the extreme positions, it is undoubtedly a very singular and specialised position. I am not saying: is it a definition that we could accept? I am saying: what can that definition teach us? You have heard enough here to know that (24) undoubtedly, that if there is something that I have often put in question it is precisely the relationship of the scientific point of view, in so far as its aim is always to consider the lack as being able to be filled in every case, with the problematic of an experience including in itself, of taking the lack as such into account.

It nevertheless remains that such a point of view is useful to pinpoint, especially if one relates it, if one links it to an article by another analyst, an older article by Barbara Low, concerning what she calls the Entschädigung, the compensations of the position of the analyst. You will see produced there a completely opposite reference, which is not to that of the scholar, but to that of the artist, and that moreover what is involved in analysis is something quite comparable, she tells us - it is certainly not any less remarkable as an analysis as regard the firmness of its conceptions - quite comparable, she tells us, to the sublimation which presides over artistic creation. Could we not with these three texts - the third of which is in the International Zeitschrift of year 20, I mean the 20th year of the International Zeitschrift für Psychoanalyse in German: despite its rarity I will make it available to whoever is willing to take responsibility for it - could we not decide that on the 20th February, which is the day that my return - since I am going to absent myself now - is possible, but not certain, could we not decide that two or three persons, two persons who are here and whom I questioned earlier, by dividing up the roles among themselves as they see fit, one to present, the other to criticise or comment, or on the contrary alternating like a choir the two parts that these two opposing presentations would constitute, could these two persons, linking up if necessary with a third for the third article - it is not unthinkable - commit themselves to not leaving this rostrum empty for too long and to take my place if I am not there, with me in the audience if I return, this problem, namely to occupy themselves exactly with the three articles that I have just spoken about.

I think I have obtained from two of them - I mean Granoff and Perrier - their consent earlier; I invite you here then to listen to them on the 20th February, namely in exactly three weeks time.

Seminar 12: Wednesday 27 February 1963

Good! Well here I am back from winter sports. The greater part of my reflections there were of course as usual concerned with being of service to you. Not exclusively however. That is why the winter sports this year, apart from the fact that I enjoyed them, which is not always the case, struck me by something or other which appeared to me and which brought me back to a problem of which they seem to be an obvious incarnation, a living materialisation, it is the contemporary one of the function of the concentration camp for the wealthy old, which as everyone knows will become more and more of a problem with the advance of our civilisation given the advance of the average age over time: that reminded me that obviously this problem of the concentration camp and of its function at this epoch of our history has really been completely missed up to now, completely masked by the era of cretinous moralising which immediately followed the end of the war, and the absurd idea that we were going to be able to finish just as quickly with them, I am still talking about concentration camps. Indeed I will not go on any longer about the different commercial travellers who made a specialty of stifling the affair, in the first rank of whom there was, as you know, one who received the Nobel Prize. We saw the degree to which he was up to his heroism of the absurd when he had to make up his mind about a serious contemporary question.

All of that to remind us - because moreover in parallel with these reflections I was rereading, I say it again as I did earlier, in order to be of service to you, my seminar on Ethics of a few years ago and this to renew the well founded nature of what I believe I articulated there as being the most essential according to our master Freud, what I think I emphasised there in a fashion worthy of the truth that was involved, that all morality is to be sought in its origin, in its source, on the side of the Real. Again you have to know of course what is meant by that. I think that for those who understood this seminar more precisely morality is to be sought on the side of the real and more especially in politics. This is not to encourage you to go looking for it in the Common Market!

So now I am going not only to invite to speak but also give the presiding role, as they say, or more exactly the position of chairman to the one who occupied it the last time, Granoff, who is going to come up here, because he is going to have to reply -

(2) since he gave a general introduction - to the three parts, and is going to have say at least a few words in reply to Madame Aulagnier who is going to complete today the loop of what was begun the last time.

Granoff here then, and Aulagnier here. Aulagnier is going to tell us what she extracted from her work on the article by Margaret Little.

Madame Aulagnier on Margaret Little's article, pp 3 - 13.

Lacan: Would you like to say the few concluding words that I suggested, that you were going to give, according to what I read - I will tell you later how I learned what was said the last time - but anyway I know enough about it to know that you announced that you should bring things to a close.

Granoff concludes, pp 13-17.

(17) It was not at all a bad idea of mine to ask Granoff to conclude, not simply because he has freed me from a part of my task of criticism, but because I believe he has completed in a satisfactory fashion and at the same time clarified what I believe I picked up from a rapid reading of the introductory talk that he gave the last time, and which - perhaps not rightly, but after all, I say in a rapid reading - left me a little unsatisfied.

I must say that with respect to the task that had been reserved to him, specifically as regards the article by Barbara Low, I found him a little bit short of the truth, in a word, not to have exhausted everything that can be drawn from this article which is certainly by far the most extraordinary and the most remarkable of the three.

I saw a little bit the sign of an evasion in the fact that he sent us back, referred us to the most modern form of intervention on the subject in the shape of this article by Lucia Tower; on the other hand I am on the whole grateful to him because this article has now been introduced, and I would not have done it for many reasons myself this year, but now we can no longer avoid it.

We will have to find a way of making this article of Lucia Tower, which he was not able to summarise, available; at least bring it to the knowledge of a certain number of people to whom it would be of the greatest interest.

This to orient things in the way I want to tackle them now for the half-hour or the thirty-five minutes that remain to us. I am not going to say much more to you about what I know each one of you contributed, even though I am very grateful to Perrier for having sent me yesterday a little summary of what he for his part contributed, a summary that was made necessary by the fact which I do not need to labour too much, that I was not able to have in time even a typed account of what was said the last time.

Whether it is the effect of chance or of bad organisation, it is certainly not because of me that things have happened in this way; because during the whole of the intervening time I tried to (18) take every possible precaution that such an accident would not happen.

Therefore I am leaving myself time. And perhaps even to be better informed, to make an allusion to the points of detail that I would like to pick up. The authors of these interventions will therefore lose nothing by waiting for a little while. I think that in general you know enough about what I wanted to contribute by referring to these articles which at first appear to be and are effectively all centred on counter-transference, which is precisely a subject which I do not claim to see in any way being even specified for you in the way it deserves, and therefore to have done this from the perspective of what I have to say to you about anxiety, more exactly about the function that this reference to anxiety ought to fulfill in the general sequence of my teaching.

The fact is that effectively these remarks about anxiety can no longer be kept at a distance from a more precise approach to what has been present in an always more insistent fashion for some time in my discourse, namely the problem of the desire of the analyst.

For when all is said and done, this at least cannot fail to escape the hardest-hearing ears: the fact is that in the difficulty of the approach of these authors to counter-transference, it is the problem of the desire of the analyst which creates the obstacle, which creates the obstacle because in short taken generally, namely not elaborated as we have done it here, every intervention of this order, however surprising this may appear after sixty years of analytic development, seems to share a fundamental imprudence.

The people involved, whether we are dealing with Szasz, or with Barbara Low herself, whether we are dealing still more with Margaret Little - and I will say later how things have been advanced in this respect in the extraordinary confidences in which Lucia Tower, the most recent author, has spoken about very profoundly on this subject, more specifically has made a very profound avowal of her experience - none of these authors can avoid putting things on the plane of desire. The term counter-transference, as it is envisaged, namely, in general, broadly speaking the participation of the analyst, but let us not forget that more essential than the engagement of the analyst, in connection with which you see there being produced in the texts the most extreme vacillations from their hundred-percent responsibility to staying completely out of it

(19) I believe that in this respect the final article, the one which you unfortunately know only under an indicative form, the one by Lucia Tower, highlights well, not for the first time, but for the first time in an articulated manner something that is

much more suggestive in this order, namely that which in the analytic relationship can occur on the side of the analyst in terms of what she calls a small change for him, the analyst - this reciprocity of action is here something which I am not saying at all is the essential term, let us say that the simple evocation of it is well designed to reestablish the question at the level at which it should be posed. It is not a matter in effect of definition, even of an exact definition of counter-transference, which could be given very simply, which is simply nothing other than the following which has only one drawback as a definition, which is that it abandons completely the question which is posed about its import, namely that counter-transference is everything that the psychoanalyst represses of what he receives as signifier in the analysis. It is nothing else and this is why this question of counter-transference is really not the question. It is from the state of confusion that it is brought to us in that it takes on its signification. This signification alone is the one from which no author can escape precisely in the measure that he tackles it and in the measure that this is what interests him, it is the desire of the analyst.

If this question is not simply not resolved, but finally has not even begun to be resolved, it is simply because there is not in analytic theory up to the present, I mean up to this seminar precisely, any exact positioning of what desire is.

It is no doubt because to do it is not a small undertaking. Moreover you can see that I never claimed to do it in one step. For example: the fashion in which I introduced it of distinguishing, of teaching you to situate desire as distinct compared to demand. And specifically at the beginning of this year I introduced something new, suggesting it to you first to see your response or your reactions, at they say, which were not lacking, namely the identity, as I put it, of desire and the law.

It is rather curious that something so obvious - because it is an obvious fact inscribed in the first steps of analytic doctrine itself - that something so evident can only be introduced or (20) reintroduced if you wish with such precautions.

This is why I come back today to this plane to show certain aspects, indeed implications of it. Desire then is the law. It is not only the fact that in analytic doctrine, with the Oedipus complex as its central corpus, it is clear that what constitutes the substance of the law is the desire for the mother, that inversely what normatives desire itself, what situates it as desire, is what is called the law of the prohibition of incest.

Let us take things from the angle, through the way in, defined by this word which has a presentified meaning in the very times in which we live, erotism.

We know, that its Sadean if not its sadistic manifestation, is the most exemplary one. Desire presents itself as a will to

jouissance from whatever angle it appears - I spoke about the Sadean angle, I did not say the sadistic one, it is just as true for what is called masochism.

It is quite clear that if something is revealed by analytic experience, it is that even in perversion where desire in sum appears by presenting itself as what lays down the law, namely as a subversion of the law, it is in fact well and truly the support of a law. If there is something that we now know about the pervert, it is that what appears from the outside as satisfaction without restraint is defence, is well and truly the bringing into play, into action of a law in so far as it restrains, it suspends, it stops, precisely on the path of this jouissance.

The will to jouissance in the pervert as in everyone else, is a will which fails, which encounters its own limit, its own restraint, in the very exercise as such of the perverse desire. In a word, the pervert does not know, as was very well emphasised by one of the people who spoke today at my request, he does not know at the service of what jouissance his activity is exercised. It is not in any case at the service of his own.

It is this which allows there to be situated what is involved at the level of the neurotic. The neurotic is characterised by the following - and this is why he was the place of passage, the path to lead us to this discovery, which is a decisive path in morality - that the true nature of desire in so far as this decisive path is not taken except from the moment that here (21) attention has been focussed on what I am expressly in the process of articulating before you just now, the neurotic was this exemplary path in the sense that he shows us, for his part, that it is by way of the search for, the establishment of the law itself that he needs to pass to give its status to his desire, to sustain his desire. The neurotic more than anybody else highlights this exemplary fact that he can only desire in accordance with the law. He cannot for his part sustain, give its status to his desire except as unsatisfied for himself or as impossible. It remains that I am giving myself the easier task in speaking to you only of the hysteric or the obsessional, because this is to leave completely outside the field of the neurosis ;;hat we are still embarrassed by along the whole path we have taken, namely anxiety neurosis about which I hope this year, as regards what we have engaged on here, to make you take the necessary step. Let us not forget that it is from this that Freud began and that, if death, his death, deprived us of something, if is not to have allowed him fully the time to come back to it. We are therefore placed, however paradoxical this may appear to you as regards the subject of anxiety, we are placed, we are brought back to this crucial plane, to this crucial point that I will call the myth of the moral law, namely that any healthy position of the moral law is supposed to be sought in the sense of an autonomy' of the subject.

The very accent of this research, the always greater emphasising in the course of the history of these ethical theories, of this

notion of autonomy sufficiently shows what is involved, namely a defence, that what it is a matter of swallowing, is this first and obvious truth that the moral law is heteronomous; this is why I insist on the fact that it proceeds from what I am calling the real in so far as it intervenes, as it intervenes when it intervenes essentially, as Freud tells us, by eliding the subject, by determining by its very intervention what is called repression and which only takes on its full meaning if we start from this synchronic function, in so far as I articulated it before you by pointing out to you, in a first approximation, what effacing traces means. This is obviously only a first approximation because everyone knows precisely that the traces are not effaced and that this is what constitutes the aporia of this affair, the aporia which is not one for you, since it is very precisely for this reason that there is elaborated before (22) you the notion of signifier, and that what is involved is, not the effacing of traces, but the return of the signifier to the state of trace, the abolition of this passage from the trace to the signifier which is constituted by what I tried to get you to sense, to describe for you by putting in the parenthesis of the trace, an underlining, a dam, a mark of the trace. This is what is demolished with the intervention of the real. The real referring the subject back to the trace, abolishes the subject also at the same time: for there is no subject except through the signifier, through this passage to the signifier: a signifier is that which represents the subject for another signifier.

To grasp the source of what is involved here, not in the always too facile perspective of history and of memory, because forgetting appears to be a too material, too natural thing for it to be believed that it does not happen all by itself, even though it is the most mysterious thing in the world from the moment that memory is posited as existing. That is why I am trying to introduce you into a dimension which is transversal, not yet as synchronic as the other.

Let us take the masochist. The maso, as they say, it appears, somewhere, namely the most enigmatic to be put in suspense from the point of view of perversion. He, you are going to tell me., for his part knows well that it is the Other who enjoys. This would be then the pervert who has brought his truth to light. He would be the exception to everything that I said earlier about the pervert not knowing how to enjoy: of course, it is always the Other, and the maso is supposed to know it. Well then I will no doubt come back to it. As of now I want to emphasise that what escapes the masochist and what puts him in the same position as all the perverts, is that he believes of course that what he is looking for, is the jouissance of the Other; but precisely, since he believes it, that is not what he is looking for. What escapes him, even though it is a tangible truth, really lying about everywhere and within everybody's reach, but for all that never seen at its true level of functioning, is that he seeks the anxiety of the Other.

Which does not mean that he is trying to annoy him. Because for

want of understanding what is meant by seeking the anxiety of the Other - naturally it is at its gross, even stupid level that things are brought to by a sort of common sense - for want of (23) being able to see the truth there is behind that, of course one abandons this shell in which something more profound is contained, which is formulated in the way that I have just told you.

This is why it is necessary for us to return to the theory of anxiety, of anxiety as signal, and for us to see the difference, or more exactly to the new thing that is contributed by the dimension introduced by the teaching of Lacan about anxiety in so far as not opposing Freud, but placed for the moment in two columns. We will say that Freud at the end of his elaboration, speaks about anxiety as signal being produced in the ego about what? An internal danger. It is a sign representing something for someone: the internal danger for the ego. The transition, the essential passage which allows this structure itself to be used by giving it its full meaning and this notion of internal, of internal danger to be suppressed: there is no internal danger because - as paradoxically to the eyes of distracted ears, I say, as paradoxically when I returned to it when I gave you my seminar on Ethics, namely to the topology of the Entwurf - there is no internal danger because this envelope of the neurological apparatus, in so far as it is a theory of this apparatus which is given, this envelope has no interior because it has only a single surface, that the Psi-system as Aufbau, as structure, as that which interposes itself between perception and consciousness, is situated in another dimension as other qua locus of the signifier; that henceforward anxiety is introduced at first, as I did it before the seminar of this year, last year, as a specific manifestation at this level of the desire of the Other as such.

What does the desire of the Other represent qua coming from this angle? It is here that the signal takes on its value, the signal that, if it is produced in a place that one can call the ego topologically, clearly concerns someone else. The ego is the locus of the signal. But it is not for the ego that the signal is given. It is quite obvious that if this lights up at the level of the ego, it is in order that the subject - one cannot call it anything else - should be warned about something.

He is warned about this something which is a desire, namely a demand which does not concern any need, which does not concern anything other than my very being, namely which puts me in question - let us say that it cancels it out: in principle it is (24) not addressed to me as present - which is addressed to me, if you wish, as expected, which is addressed to me much more again as lost and which, in order that the Other should be able to locate himself (s'y retrouve) requests my loss.

That is what anxiety is. The desire of the Other does not recognise me, as Hegel believes, which renders the question quite easy. For if he recognises me, since he will never recognise me

sufficiently, all that is left to me is to use violence. Therefore he neither recognises me nor miscognises me. Because that would be too easy: I can always escape from it by struggle and violence. He puts me in question, interrogates me at the very root of my own desire as o, as cause of this desire and not as object, and it is because he is aiming at this in a relationship of antecedence, in a temporal relationship, that I can do nothing to break this grip except by engaging myself in it. It is this temporal dimension which is anxiety, and it is this temporal dimension which is that of analysis. It is because the desire of the analyst stimulates in me this dimension of expectation that I am caught in this something which is the efficacy of the analysis. I would really like him to see me as such and such, for him to make of me an object. The relationship to the other, the Hegelian one here, is very convenient, because then in effect I have all sorts of resistances against that, and against this other dimension let us say a good part of the resistance slips. Only for that it is necessary to know what desire is and to see its function, not at all simply on the plane of the struggle, but there where Hegel - and for good reason - did not want to go looking for it, on the plane of love.

Now, if you go - and perhaps you will go with me, because after all the more I think about it and the more I speak about it and the more I find indispensable to illustrate the things I am speaking about - if you read the article by Lucia Tower, you will see this story: two gentlemen (bonshommes) - to speak as one spoke after the war, when one spoke about ladies (des bonnes femmes) in a certain milieu - you will see two gentlemen with whom, what she recounts, what she recounts is particularly illustrative and efficacious, they are two love stories.

Why did the thing succeed? In one case when she was touched herself, it is not she who touched the other, it is the other who put her on to the plane of love; and in the other case the other did not get to it and that is not interpretation, because it is written down and she says why.

(23) And this is designed to induce in us some reflections on the fact that, if there are some people who have said something sensible about counter-transference, it is uniquely women.

You will say to me: Michael Balint? Only it is rather striking that he wrote his article with Alice. Ella Sharpe, Margaret Little, Barbara Low, Lucia Tower. Why is it that it is women who, let us already simply say, have dared to speak about the thing in an overwhelming majority and that they should have said interesting things? It is a question that will be completely clarified if we take it from the angle I am talking about, namely the function of desire, the function of desire in love in connection with which, I think, you are mature enough to hear the following - which moreover is a truth which has always been well known, but to which its place has never been given, it is that in so far as desire intervenes in love and has as I might say an essential stake in it, desire does not concern the beloved

object.

As long as this primary truth around which alone can turn a valid dialectic of love is put for you in the ranks of an Erniedrigung an accident of love life, of an Oedipus complex which grows paws, well then, you will understand absolutely nothing about what is involved, about the way the question should be posed as regards what the desire of the analyst may be. It is because it is necessary to start from the experience of love, as I did in the year of my seminar on transference, to situate the topology in which this transference can be inscribed, it is because it is necessary to start from there that today I am bringing you back to it.

But no doubt my discourse will take on, from the fact that I am going to terminate it here, an interrupted appearance. What I produced there at the final term as a formula, can be taken as a pause, a chapter heading or conclusion as you wish. After all it is permissible for you to take it as a stumbling block or if you wish as a banality. But it is here that I intend that we should take up the next time the rest of our discourse to situate in it exactly the indicative function of anxiety and what it will allow us subsequently to gain access to.

Seminar 13: Wednesday 6 March 1963

We are going then to continue our journey of approach to anxiety, which I would like you to understand is indeed of the order of an approach. Of course, you are already sufficiently advised by what I am producing here, that I want to teach you that anxiety is not what shallow people think. Nevertheless you will see, in rereading afterwards the texts on this major point, that what you have learned is far from being absent from them; simply it is masked and veiled at the same time, it is masked by formulae which are styles perhaps that are too cautious under their coating, as one might say, their carapace. The best authors allow there to appear what I already put the accent on for you, that it is not objektlos, that it is not without an object.

The sentence which in Hemmung, Symptom und Angst precedes, in Appendix B "Ergänzung zur Angst", "Supplementary remarks on anxiety", the very sentence which precedes the reference that Freud makes, following in this the tradition of indétermination, to the Objektlosigkeit of anxiety - and after all I would only need to remind you of the bulk of the article itself to say that this characteristic of being without an object cannot be retained - but the sentence just before, Freud says anxiety is "Die Angst ist Angst vor etwas", it is essentially anxiety about something.

Can we be satisfied with this formula? Of course not. I think that we ought to go much further, say more about this structure, this structure which already, as you see, opposes it by contrast, if it is a fact that anxiety, being the relationship with this object that I approached which is the cause of desire, is opposed by contrast with this vor, how has this thing which I placed for you promoting desire behind desire, gone in front of it, this is perhaps one of the sources of the problem.

In any case, let us underline clearly that we find ourselves in the tradition before what is called an almost literary theme, a commonplace, the one between fear and anxiety which all the authors, referring to the semantic position, oppose at least at the beginning, even if subsequently they tend to bring them together or to reduce them to one another - which is not the case among the best of them. At the beginning undoubtedly one tends to emphasise this opposition between fear and anxiety by, let us say, differentiating their position with respect to the object.

And it is really tangible, paradoxical, significant of the error (2) thus committed that one is led to stress that fear, for its part, has one, has an object.

Breaking through a certain characteristic, there is here an objective danger, Gefahr, dangeite, Gef "áhrdung, a danger situation, the entry of the subject into danger, which would after all deserve a pause: what is a danger? We are going to be told that fear is by its nature, adequate to, in correspondence with, entsprechend to the object from which the danger comes.

The article of Goldstein on the problem of anxiety on which we will pause, is in this regard very significant of this sort of slipping, of seduction, of capture, as one might say, of the pen of an author - who in this matter was able to gather together, as you will see, the essential and very precious characteristics of our subject - the seduction of the pen by a thesis, insisting in a fashion which one can say is in no way required by its subject in this respect - because it is anxiety that is involved - insisting, as one might say on the oriented character of fear, as if fear were already made up completely of the locating of the object, of the organisation of the response, of the opposition, of the Entgegendstehen between what is Umwelt and everything which in the subject has to face up to it.

It is not enough to evoke the first reference summoned to my memory by such propositions: I remembered what I believe I had already underlined for you in a little, one cannot call that a short story, notation, impression of Chekov which was translated using the term "frights (frayeurs)". I tried it in vain to inform myself of the title of this short story in Russian; because, inexplicably, none of my Russian-speaking listeners were able to find for me this notation, which is perfectly well located with its year in the French translation, even with the help of this date, in the editions of Chekov which are nevertheless in general produced chronologically. It is peculiar, it is upsetting and I cannot say that I am not disappointed about it - in this notation under the term of "Frights", the frights that Chekov himself experienced - I already pointed out to you once, I believe, what was involved - one day, with a young boy who was driving his sledge - his droschka, I believe it is called, something like that - he is going along a plane, and, in the distance, at sunset, the sun already setting on the horizon, he sees in a church tower which appears, at a range that he could reasonably see its details, he sees flickering through a skylight on a very (3) high storey of the tower to which he knows, because he knows the place, one cannot gain entry in any way, a mysterious inexplicable flame which nothing allows him to attribute to any effect of reflection; there is here obviously the mapping out of something: he makes a short reckoning of what can or cannot account for the existence of this phenomenon and, having really excluded every kind of known cause," he is all of a sudden gripped by something which I believe in reading this text can in no way be called anxiety, he is gripped by what he himself calls moreover, for want obviously of being able to have at present the

Russian term, which was translated by frights - I believe this is what corresponds best to the text - it is of the order not of anxiety, but of fear (peur); and what he is afraid of, is not anything that threatens him, it is something which has precisely this character of referring to the unknown in what is manifesting itself to him. The examples that he gives subsequently under this same heading, namely the fact that one day, he sees passing along the horizon, on the railway, a type of wagon which gives him the impression, to hear his description, of a phantom wagon, because nothing is pulling it, nothing explains its movement: a wagon passes at full speed along the curve of the railway which is there at that moment before him. Where has it come from? Where is it going? This sort of apparition torn away in appearance from any determinism that can be located, here again is something that throws him for a moment into disorder, a veritable panic, which is well and truly of the order of fear: there is no menace there either and the characteristic of anxiety is undoubtedly lacking in this sense that the subject is neither seized, nor involved in this innermost part of himself which is the aspect by which anxiety is characterised, on which I am insisting.

The third example, is the example of a thoroughbred dog which nothing allows him, given the fact that he has completely mapped out everything that surrounds him, whose presence nothing allows him to explain at this time, in this place; he begins to foment the mystery of Faust's dog, thinks he can see the form under which the devil is approaching him; it is well and truly from the side of the unknown that fear develops here, and it is not of an object, it is not of the dog who is there that he is afraid, it is of something else, it is behind the dog.

On the other hand, it is clear that what is insisted on, that the effects of fear have in a way a character of adequation, in (4) principle, namely of unleashing a flight reaction, is sufficiently compromised by what one must indeed put the accent on, that in many cases paralysing fear manifests itself in an inhibiting, even fully disorganising action, indeed can throw the subject into a disarray which is least adapted to the response, least adapted to the finality, which might be supposed to be the adequate subjective form.

It is elsewhere, therefore, that there must be sought the distinction, the reference by which anxiety is to be distinguished from it. And you can well imagine that it is not simply a paradox, a desire to play with an inversion, if I put forward here before you that anxiety is not without object, a formula whose form undoubtedly designates this subjective relationship which is that of a halting-place, a starting-place from which I want to advance further today; because of course the term object has been long prepared here by me with an accent which is distinguished from what the authors have up to now defined as object when they speak about the object of fear.

It is easy to give immediately its support to this vor Etwas of

Freud, of course, because Freud articulates it in the article and in all sorts of ways: it is what he calls the internal danger, Gefahr or Gefährdung, the one which comes from within. As I told you: it is a matter of not contenting yourself with this notion of danger, Gefahr or Gefährdung. Because, if I already signalled earlier its problematic character when an external danger is involved - in other words, what warns the subject that it is a danger if not the fear itself, if not the anxiety - but the sense that the term internal danger can have is too linked to the function of a whole structure that must be preserved, of a whole order of what we call defence, for us not to see that in the very term defence the function of danger is itself implied, but is not for all that clarified.

Let us try therefore to follow the structure in a more step by step way and to designate clearly where we intend to fix, to locate this trait of signal on which indeed Freud dwelt as being the one which is the most proper to indicate to us, to us analysts, the usage that we can make of the function of anxiety. This is what I aim at reaching along the path that I am trying to lead you.

Only the notion of the real, in the opaque function which is the one from which you know I begin in order to oppose to it that of the signifier, allows us to orientate ourselves and to say already that this Etwas before which anxiety operates as a (5) signal, is something which is let us say for man "necessary"- in quotation marks - an irreducible aspect of this real. It is in this sense that I risked giving you the formula that among all the signals, anxiety is the one which does not deceive.

Anxiety then is the signal of the real and - as I told you - of an irreducible mode under which this real presents itself in experience, this is just now, at the point that we are at, the guide, the guiding thread that I would ask you to hold onto to see where it leads us.

This real and its place, is exactly what with the support of the sign, of the bar there can be inscribed the operation which, arithmetically, is called division. I already taught you to situate the process of subjectification in so far as it is at the locus of the Other, under the primary species of the signifier, that the subject has to be constituted; at the locus of the Other and upon the given of this treasury of the signifier already constituted in the Other and just as essential for any advent of human life as everything that we can conceive of in the natural Umwelt. It is with respect to the treasury of the signifier which already awaits him, constitutes the deviation where he has to situate himself, that the subject, the subject at this mythical level which does not yet exist, which only exists starting from the signifier, which is prior to it, which is constitutive with respect to it, that the subject carries out this first interrogative operation: in

0, if
you wish, how many times S?

0	S	X
0	∅	Anxiety
\$	⊕	desire

And the operation being posited here in a certain fashion which is here in the 0 marked by this interrogation appears here, the difference between this response 0 and the given 0, something that is the remainder, the irreducible of the subject, it is o. o is what remains irreducible in this total operation of the advent of the subject to the locus of the Other, and it is from this that it is going to take on its function.

The relationship of this o to the S, the o in so far as it is precisely that which represents the S in a real and irreducible fashion, this o over S, o/S , this is what completes the operation of division, that which in effect since 0, as one might say, is something which has no common denominator, is outside the common denominator between the o and the S. If we wish conventionally to complete the operation all the same, we put as numerator the remainder, o, as denominator the divisor, the S. $\$$ is equivalent to o over S, o/S .

(6) This remainder, therefore, in so far as it is the end (chute), as one might say, of the subjective operation, this remainder, we recognise in it here structurally, in an analogy from calculation, the lost object; this is what we have to deal with, on the one hand in desire, on the other hand in anxiety. We have to deal with it in anxiety, logically, as one might say, before the moment that we have to deal with it in desire.

And if you wish, to connote the three stages of this operation, we will say that here there is an X which we can only name retroactively, and which is properly speaking the approach of the Other, the essential line of sight where the subject has to pose himself and whose name I will give you afterwards. We have here the level of anxiety in so far as it is constitutive of the apparition of the function o and it is at the third term that there appears the ^ as subject of desire.

To illustrate now, to bring alive this no doubt extreme abstraction that I have just articulated, I am going to lead you to the obviousness of the image and this of course all the more legitimately in that it is an image that is involved, that this irreducible of o is of the order of the image.

He who possessed the object of desire and of the law, he who had enjoyed his mother, Oedipus to give him his name, takes this further step, he sees what he has done. You know what happens then. How choose the word, how can one say what is of the order of the unsayable and whose image nevertheless I want to make emerge for you? The fact that he sees what he has done has as a consequence that he sees - this is the word before which I stumble - the moment afterwards his own eyes swollen with their vitreous humours on the ground, a confused pile of filth since - how can we put it? - because since he had torn his eyes from their sockets he had quite obviously lost his sight. And nevertheless it is not that he does not see them, see them as such, as cause-object finally unveiled of the final, the ultimate, no longer guilty, but beyond the limits, concupiscence,

that of having wanted to know.

The tradition even says that it is starting from that moment that he really becomes a seer. At Colonus he sees as far as it is possible to see and so far ahead that he sees the future destiny of Athens.

What is the moment of anxiety? Is it what makes possible this gesture through which Oedipus can tear out his eyes, make this sacrifice of them, this offering, this ransom of blindness in which his destiny is accomplished? Is that what anxiety is, the possibility, let us say, that man has of mutilating himself? No. (7) It is properly that which through this image, I am striving to designate for you: it is that an impossible sight threatens you of your own eyes on the ground.

Here I believe is the surest key that you can always rediscover under whatever style of approach the phenomenon of anxiety presents itself for you.

And then, however expressive, however provocative may be, as one might say, the narrowness of the locality that I designate for you as being that which is circumscribed by anxiety, you should notice that this image is found there as beyond the limits, not because of some preciousness in my choice, it is not an eccentric choice; it is, once I have designated it for you, well and truly frequent to encounter it. Go to the first exhibition currently open to the public, at the Musee des Arts Decoratifs and you will see two Zurbarans, one from Montpellier, the other from somewhere else which represent for you I believe, Lucy and Agatha each one with their eyes on a plate, the match of their breasts. Martyrs, let us say, which means witnesses of what is seen here moreover, that it is not, as a I told you, what is possible, namely the fact that these eyes being denucleated, these breasts being torn off, which is anxiety. Because in truth, something which also deserves to be noticed, these Christian images are not especially badly tolerated, despite the fact that some people for reasons which are not always the best are a bit fastidious about them. Stendhal, speaking about San Stefano il Rotondo in Rome finds that these images which are on the walls are disgusting. Undoubtedly in the place he names they are rather lacking in art so that one is introduced, I must say, in a more lively fashion to their signification.

But these charming persons that Zurbaran presents to us, by presenting these objects on a plate, present us with nothing other than something that could be on occasion - and we do not deprive ourselves of it - the object of our desire: in no way do these images introduce us, I think, for the majority of us, to the order of anxiety.

For this, it would be necessary for him to be more personally concerned, for him to be a sadist or a masochist, for example. Once a true masochist, a true sadist is involved, which does not mean someone who can have phantasies that we pinpoint as sadistic

or masochistic, provided they reproduce the fundamental position (8) of the sadist or the masochist, the true sadist, in so far as we can locate, coordinate, construct his essential condition, the true masochist, in so far as we find ourselves, by successive mapping out, elimination, required to push further the plan of his position than what is given to us by others as Erlebnis, an Erlebnis itself more homogeneous, the Erlebnis of the neurotic, but an Erlebnis which is only a reference, a dependence, the image of something beyond, which constitutes the specificity of the perverse position and with regard to which the neurotic takes in a way his reference and his support for ends to which we will return.

Let us try therefore to say what we can presume about what this sadistic or masochistic position is, what the images of Lucy and Agatha may really interest: the key to it is anxiety. But it is necessary to seek out, know why. The masochist - I told you the other day, the last time - what is his position? What masks his phantasy from him? To be the object of a jouissance of the Other which is his own will to jouissance; for after all, the masochist does not necessarily, as a humorous apologue already quoted here reminds you, meet his partner. What does this position of object mask, if it is not to rejoin himself, to posit himself in the function of human rag, of this poor scrap separated from the body which is presented to us here. And this is why I tell you that the aim of the jouissance of the Other is a phantastical aim. What is sought, is in the Other, the response to this essential collapse of the subject into his final misery which is anxiety. Where is this Other that is involved? Here indeed is the reason why there was produced in this circle the third term always present in perverse jouissance: the profound ambiguity in which there is situated an apparently dual relationship is rediscovered here. Because moreover I have to make you sense where I intend to indicate this anxiety to you. We could say - and the thing is sufficiently highlighted by all sorts of features of history - that this anxiety which is the blind aim of the masochist - for his phantasy masks it from him - is nonetheless really what we could call the anxiety of God.

Do I need to appeal to the most fundamental Christian myth to give substance to everything that I am advancing here, namely that if the whole Christian adventure is not engaged in this central, inaugural, attempt, incarnated by a man whose every word is to be reheard again as those of someone who pushed things to their final term of an anxiety which only finds its veritable cycle at the level of him for whom the sacrifice is set up, namely at the level of the father.

God has no soul. That is quite obvious. No theologian has ever dreamt of attributing one to him. Nevertheless the total, radical change of perspective of the relationship to God began with a drama, a passion in which someone made himself the soul of God. Since it is because the place of the soul is also situated at this level of the residue of the fallen object that is involved, that is essentially involved, that there is no living

conception of the soul, with the whole dramatic cortege in which this notion appears and functions in our cultural domain, unless it is accompanied precisely in the most essential fashion by this image of the fall.

Everything that Kierkegaard articulates is only a reference to these great structural reference points. Now then observe that I began with the masochist. It was the more difficult; but as a matter of fact it was the one which avoided confusions. Because one can understand better what a sadist is; and the snare involved here in making of it only the reversal, the other side, the inverted position of the masochist, unless one proceeds - which is what is usually done - in the opposite sense.

In the sadist, anxiety is less hidden. It is even so little so that it comes to the fore in the phantasy, which, if one analyses it makes of the anxiety of the victim an altogether required condition. Only this is the very thing which ought to make us suspicious. What the sadist seeks in the Other - because it is quite clear that for him the Other exists and it is not because he takes him as object that we ought to say that there is some relationship or other that we could call immature or again, as it is put, pregenital, the Other is absolutely essential and this indeed is what I wanted to articulate when I gave you my seminar on Ethics by bringing together Sade and Kant, the essential putting into question of the Other which goes so far as to simulate, and not by chance, the requirements of the moral law, which are indeed there to show us that the reference to the Other as such forms part of his aim - what is he searching for there?

It is here that the texts, the texts that we can hold onto, I (10) mean those which give some hold on an adequate critique, take on their value, of course, a value signaled by the strangeness of some moments, of some detours which in a way detach themselves, explode with respect to the line that is being followed. I will leave you to search in Juliette, even in the One hundred and twenty days, these few passages where the characters, completely occupied in slaking on these chosen victims their greed for torments, enter into this bizarre, singular and curious trance, indicated, I repeat, on several occasions in the text of Sade, which is expressed in these strange words, in effect that it is necessary for me to articulate here: "I had," cries the tormentor, "I had the skin of the cunt".

This is not a feature which is obvious along the track of the imaginable, and the privileged character, the moment of enthusiasm, the character of supreme trophy brandished at the high point of the chapter is something which, I believe, is sufficiently indicative of the following: it is that something is sought which is in a way the reverse (l'envers) of the subject, which takes on here its signification from this feature of the glove turned inside-out which underlines the feminine essence of the victim. It is the passage to the outside of what is most hidden that is involved; but let us observe at the same time that

this moment is in a way indicated in the text itself as being totally impenetrated by the subject, allowing there precisely to be masked here the trait of his own anxiety.

In a word, if there is something for that matter which evokes how little light we can throw on the truly sadistic relationship, that the form of explanatory texts turn aside from the phantasy, if there is something that they suggest to us, it is in a way the instrumental character to which the function of the agent is reduced. That which in a way is hidden, except in a flash, the aim of his action, is the work aspect of his operation. He also has a relationship with God, this is what is exposed everywhere in Sade's text. He cannot take a step forward without this reference to the supremely wicked being and it is just as clear for him as for the one who is speaking that it is God that is involved.

For his part he goes to all sorts of exhausting trouble, even to the extent of missing his goal, to realise - which, thank God, it has to be said, Sade spares us having to reconstruct, for he articulates it as such - to realise the jouissance of God.

I think I have shown you here the game of occultation through which anxiety and object, in the one and in the other, are (11) brought to the forefront, one at the expense of the other term, but how also in the structures there is designated, there is declared the radical link between anxiety and this object in so far as it falls. In that very way its essential function is approached, its decisive function as remainder of the subject, the subject as a real. Undoubtedly this invites us to look again, to place a greater accent on the reality of these objects. And in moving on to this following chapter, I cannot fail to remark the degree to which this real status of objects, already nevertheless located for us, has been left to one side, been badly defined by people who would nevertheless like to consider themselves as the biologising reference points and bearings of psychoanalysis for you.

Is it not the occasion to notice a certain number of outstanding features which I would wish, as best I can and pushing my plough in front of me, to introduce you to. Because the breasts, since we have them there for example on Saint Agatha's plate, is it not an opportunity to reflect, since - it has been said already a long time ago - anxiety appears in separation; but then - we see it clearly - if they are separable objects, they are not separable by chance like the leg of a grasshopper, they are separable because they already have, as I might say, very sufficiently, anatomically a certain stuck on character, they are hung there. This very particular character of certain anatomical parts completely specifies a sector of the animal scale, the one that one calls precisely, not without reason, it is even rather curious that this quite essential, properly speaking signifying character of this trait has been noticed; because after all it seems that there are more structural things than the mammary to designate a certain animal grouping which has many other traits

of homogeneity through which it could be designated.

This trait was no doubt chosen, and it was not a mistake. But it is indeed one of the cases where one sees the fact that the objectifying spirit is itself not uninfluenced by the pregnancy of psychological functions, I would say, to make myself understood by those who have not yet understood, a certain feature of pregnancy which is not simply significant, which induces in us certain significations in which we are very much engaged.

Viviparous-oviparous: a division really made to confuse us. Because all animals are viviparous because they generate eggs in which there is a living being and all animals are oviparous because there is no vivipar which was not vivipared inside an egg.

But why not really give all its importance to this fact which is really completely analogous to this breast which I earlier spoke to you about, that for the eggs which have a certain time of intrauterine life, there is this element, irreducible to the division of the egg in itself, which is called the placenta, that there is here also something stuck on and that in a word it is not so much the child who pumps milk from the mother as the breast, just as it is the existence of the placenta which gives to the position of the child inside the body of the mother its characteristics - sometimes manifested on a pathological plane - of parasitic nesting. You see where I intend to put the emphasis: on the privilege at a certain level of elements that we could qualify as amboceptors.

On what side is this breast? On the side of the one who sucks or on the side of the one who is sucked? And after all I am doing nothing here other than reminding you of something that effectively analytic theory was led to, namely to speak, I would not say indifferently, but with ambiguity in certain sentences, of the breast or of the mother, underlining of course that it is not the same thing. But has everything been said when the breast is qualified as a partial object?

When I say amboceptor, I am underlining that it is as necessary to articulate the relationship of the maternal subject to the breast as that of the suckling to the breast. The cut does not happen in the same place for the two; there are two cuts so distant that they even leave different residues (dechets) for the two. Because the cutting of the cord for the child leaves separated from him droppings (chutes) which are called the envelopes. This is homogeneous with himself and in continuity with his ectoderm and his endoderm.

The placenta is not particularly involved in the affair. For the mother, the cut is placed at the level of the dropping of the placenta, that is even the reason why these are called des caduques and the decay (caducite) of this object o is here what constitutes its function.

Well then, all of this is not meant to make you revise immediately some of the relations deduced, imprudently deduced from a hasty sketching of what I am calling the line of separation where there is produced the dropping, the niederfallen typical of the approach of an o which is nevertheless more essential to the subject than any other part of himself.

(13) But for the moment to make you steer straight towards what is essential, namely for you to perceive where this questioning leads, to the level of castration.

For with castration also we are dealing with an organ, before we get to the castration threat, namely what I have called the possible gesture, could we not, analogously to the image that I produced today before you, see whether we do not have the indication that anxiety is to be placed elsewhere?

Because a phallus, because people are always gargling on about biology, approaching it in an unbelievably frivolous way, a phallus is not limited to the field of mammals. There are a whole lot of insects, all revolting in different ways, from the black beetle to the cockroach, which have what? Stings (des dards). The sting goes a long way in effect in the animal. The sting is an instrument, and in many cases - I do not want to give you a course in comparative anatomy today, I would ask you to refer to the authors, if necessary I will indicate them to you - the sting is an instrument: it is used for hooking on. We know nothing about the amorous enjoyments of the black beetle or the cockroach. Nothing indicates however that they are deprived of it. It is even rather probable that jouissance and sexual union are always in the closest possible relationship.

And what does it matter! Our experience as men and the experience that we can presume to be those of mammals who most resemble us conjoin the locus of the jouissance and the instrument, the sting.

While we take the thing as being self-explanatory, nothing indicates that even where the copulatory instrument is a sting or a claw, an object for hooking on, in any case neither a tumescent nor detumescent object, jouissance is linked to the function of the object.

That jouissance, orgasm in our case, to limit ourselves to ourselves, coincides with as I might say the putting out of action, the putting out of operation of the instrument by detumescence, is something that altogether deserves that we should not hold it to be something, as I might say, which is as Goldstein expresses it, part of the Wesenheit, an essential part of the organism.

(14) This coincidence of approach has nothing rigorous about it once one begins to think about it; and then it is not, as I might say, in the nature of human things. In fact what do we see in Freud's first intuition about a certain source of anxiety?

Coitus interruptus. It is precisely the case in which by the very nature of the operations being carried out the instrument is revealed in its suddenly failed function of being an accompaniment to orgasm, in so far as orgasm is supposed to signify a common satisfaction.

I leave this question in suspense. I am saying simply that anxiety is put forward by Freud in its essential function there precisely where the accompaniment of the orgasmic build-up with what is called the exercise of the instrument is precisely disjointed. The subject can reach ejaculation, but it is an ejaculation outside; and the anxiety is precisely provoked by this fact which is highlighted, what I called earlier the putting out of action of the apparatus, of the instrument of jouissance. Subjectivity, if you wish, is focussed on the collapse of the phallus. This collapse of the phallus, exists in any case in a normally completed orgasm. It is precisely to this that our attention should be directed to highlight one of the dimensions of castration.

How is copulation between man and woman experienced, this is what allows the function of castration, namely the fact that the phallus is more significant in human experience by its collapse, by its possibility of being a fallen object, than by its presence, this is what designates the possibility of the place of castration in the history of desire.

It is essential to highlight this. Because what did I end with the last time, if not by telling you: as long as desire is not structurally situated, is not distinguished from the dimension of jouissance, as long as the question is not that of knowing what is the relationship, and whether there is a relationship for each partner between desire - specifically the desire of the Other - and jouissance, the whole affair is condemned to obscurity.

Thanks to Freud we have the plane of cleavage. That is miraculous in itself. In the ultra-precocious perception that Freud had of its essential character, we have the function of castration as intimately linked to the traits of the decayed (caduc) object, of caducity as characterising it essentially. It (15) is only starting from this decayed object that we can see what is meant by speaking about partial object. In fact I will tell you right away: the partial object, is an invention of the neurotic, it is a phantasy. It is he who makes a partial object of it. As regards the orgasm and its essential relationship with the function that we define as the fall of the most real of the subject, have you not had - those who have here the experience of being analysts - the testimony of it more than once? How often have you been told that a subject had, I am not saying his first, but one of his first orgasms when he had to hand up in a great hurry the copy of a composition or of a drawing that he had to finish quickly and where there was collected what? His work, at the moment when it was absolutely expected that something would be torn from him. The collection of the copies: at that moment he ejaculates. He ejaculates at the high-point of anxiety

of course.

When people speak to us about this famous eroticisation of anxiety, is it not first of all necessary to know what relation anxiety already has with Eros? What the respective aspects of this anxiety are from the side of jouissance and from the side of desire, is what we will try to disengage the next time.

Seminar 14: Wednesday 13 March 1963

СТРАНЫ \j СТРАХА ГЛВЗ*

НЕБ ОСЬ Б ОУСЬ, ГТООН НГГРИЛГГ

Several of you were kind enough to respond to my complaint the last time of not yet having been able to find the Russian term which corresponded to this piece by Chekov which I learned about - I am saying this in passing - through Mr Kaufmann - I will come back to it later. It is Mr Kaufmann himself who, even though he is not a Russian speaker, brought me today the exact text which I asked Smirnoff for example as a Russian speaker to comment on rapidly.

I mean - indeed I scarcely dare to articulate these sounds - I do not know the phonology - to say what is involved in the title, СТсflXW which is the plural of the which **СТPhXB** gives the words that concern dread, fear, anxiety, terror, anguish and poses for us very difficult problems of translation.

It is a little bit - I am thinking about it as an improvisation, I thought of it just now - like what was raised in connection with the problem of colours, whose connotation surely does not overlap from one tongue to another. The difficulty - I already signaled it for you - that we have in grasping the term which in Russian would correspond precisely to anxiety - because this is where our troubles begin - shows it clearly.

In any case, if I correctly understood, from the debates among the Russian speakers here that this word gave rise to, it appears that in one way what I advanced the last time here was correct, namely that Chekov had not intended by this to speak about anxiety.

At this point, I come back to what wanted to render to Kaufmann, it is then very exactly the following: I used this example the last time to clarify, as one might say, in a lateral fashion, the thing whose reversal I was' trying to operate before you, namely to introduce the question, I said that it would be just as legitimate to say in fact that fear has no object; and, as I was going to announce in any case, as I already had done previously, that anxiety, for its part, was not without an object, that had a certain interest for me. But it is obvious

that this absolutely does not exhaust the question of what are these fears or frights or dreads or whatever else, which are (2) designated in the examples of Chekov.

Now, since - I do not think I am misrepresenting him - Mr Kaufmann is trying to articulate something quite precise and focussed precisely on these Chekovian frights, I think it is important to underline that I only made a lateral usage of it and one that was dependent on the one that will be brought forward by him in a work that is to be done later.

And on this point, I think that before beginning today I am going to allow you to profit from a little discovery, due again to Mr Kaufmann, who is not a Russian speaker, which is that in the course of this research he found another term, the most common term for "I am afraid", which it appears is **£iCltO£b**. it is the first word that you see written there in the two sentences; and then, in this connection, he amused himself by recognising that, if I am not mistaken, in Russian as in French, the negation described as expletive, the one on which I put such a stress, because I find in it nothing less than the signifying trace in the sentence of what I call the subject of enunciating, as distinct from the subject of the enunciation, that in Russian also, there is the affirmative sentence, I mean the sentence which designates in the affirmative, the object of my fear, what I fear, it is not that it should not come, it is that it should come, and I say: that it will come (qu'il ne vienne), where I find myself confirmed by Russian, in saying that it is not enough to qualify this expletive ne as discordant, namely to mark the discordance that there is between my fear: since I am afraid that it will come, I hope that it will not come.

Well then, it seems that in Russian we see this with still more specificity - and this goes in the direction of the value that I give this expletive ne - namely that it is indeed the subject of enunciating as such that it represents and not simply his feeling; for if again I understood correctly a little earlier, discordance in Russian is already indicated by a special nuance, namely that the **ZT06** which is there is already in itself a "that not, que ne", but marked by a different nuance. If I correctly understood Smirnoff, the **b** which distinguishes this "**2.TQ&** from the simple "that" of the **Z.T0** in the second sentence, opens, indicates a nuance of the verb, a sort of conditional aspect, in such a way that this discordance is already marked at the level of the letter £> that you see here. Which does not prevent the ne of negation, which is still more expletive therefore, from the simple point of view of the signified, functioning all the same in Russian as in French leaving open then the question of its (3) interpretation and I have just said how I resolve it. There we are!

And now how am I going to get into today's material? I will say that this morning, remarkably enough, thinking about what I was going to produce here, I started all of a sudden to evoke the time when one of my most intelligent analysands - there are still some of those - insistently posed me the question: "What

can be driving you that makes you go to all this trouble to tell them that?" It was in the arid years when linguistics, indeed the calculus of probabilities, had some place here.

In other words, I told myself that after all, it was not a bad angle either for introducing the desire of the analyst to recall that there is also a question of the desire of the teacher (l'enseignant).

I will not give you the word here and for good reasons. But it is striking that when, through a hint of culpability that I experience at the level of what one could call human tenderness, I think of the tranquillities that I am striving for, I am very ready to put forward the excuse - you saw it being highlighted on several occasions - that for example I would not be teaching if the split had not happened.

But it is not true. But, indeed, obviously, I would have liked to devote myself to more limited, more intermittent work; but fundamentally that does not change anything.

In short the fact that one can pose the question of the desire of the teacher to someone is the sign I would say, as Monsieur de La Palisse would say, that the question exists; it is also the sign that there is a teaching. But this introduces us when all is said and done to this curious remark that, where one does not pose the question, it is because there is a professor. The professor exists every time the response to this question is, as I might say, written, written in his appearance or in his behaviour, in this sort of conditioning that one can situate at the level of what, in short, in analysis we call the preconscious, namely of something that one can make emerge, wherever it comes from, from institutions or even from what are called his penchants.

At this level it is not useless to see then that the professor is defined as the one who teaches about teachings, in other words: he carves up teachings. If this truth were better known, that what is involved in fact at the level of the professor is something analogous to a collage, if this truth were better known (4) it would allow them to do it with more consummate art, which precisely the collage which has taken its meaning through a work of art shows us the way to. Namely if they made their collage in a way that is less concerned about fitting together, less restrained, they would have some chance of ending up at the very result that collage aims at, of evoking properly speaking this lack which gives all its value to the figurative work itself, when it succeeds of course. Along this path therefore they would manage to connect up with the proper effect of what is precisely a teaching.

There you are! This then to situate, to pay homage to those who are willing to take the trouble to see by their presence what is taught here, not alone to pay tribute to them, but to thank them for taking this trouble.

On this, for my own part, I am going - because moreover I have sometimes to deal with listeners who only come here in an intermittent fashion - to attempt to make myself for a moment the professor of my own teaching and since the last time I brought you the elements that I believe are sufficiently massive, to recall the major point of what I contributed the last time.

Starting then from the distinction between anxiety and fear, I tried as I reminded you just now, at least as a first step to upset the opposition at which there came to a stop the last development of the distinction between them which is accepted by everyone today.

It is certainly not in the direction of a transition from one to the other that the movement goes. If traces of it remain in Freud, that can only be because of the error of attributing to him the idea of this reduction of one to the other, an error founded on what I reminded you there was in him precisely as a beginning of what in reality is this reversal of positions, in this sense that if he says precisely, despite the fact that at one or other detour of his sentences the term objektlos turns up, he says that anxiety is "Angst vor Etwas", an anxiety about something, it is certainly not to reduce it to being another form of fear, because what he underlines, is the essential distinction between the provenance of what provokes the one and the other.

Therefore it is indeed on the side of the refusal of any emphasis that tends to isolate fear from the entgegenstehen, from what poses itself in front, from fear as response, entgegen precisely, that what I said in passing about fear has to be retained.

(5) On the contrary, it is indeed to recall at first that in anxiety, the subject is, I would say held, concerned, involved in the innermost part of himself, that simply on the phenomenological plane we see already the beginnings of what I tried to articulate further in a more precise fashion. I recalled in this connection the close relationship between anxiety and the whole apparatus of what are called "defences". And on this path I highlighted again, not without having already articulated, prepared it in all sorts of ways, that it is indeed from the side of the real, as a first approximation, that we have to seek anxiety as that which does not deceive.

This is not to say that the real exhausts the notion of what anxiety aims at. What anxiety aims at in the real, that with respect to which it presents itself as a signal, is that whose position I tried to show you in the table called, as I might say, that of the signifying division of the subject in which the X of a primitive

(S) <i>Jouissance</i>	namely his becoming as subject, this relationship of 0 over S, according to the figure of a division, of a subject <i>s</i> with respect to the 0 of the Other, in so far as it is along this path of the Other that the subject has to realise himself.
\emptyset <i>Anxiety</i> <i>desire</i>	

It is this subject - I left it undetermined for you as regards

subject moves towards his becoming (avenement),

its denomination in the first terms of these columns of division whose other terms are found posited according to the forms which I already commented on - that I inscribe here as (^).

The end of my discourse, I think, sufficiently allowed you to recognise how at this mythical level, S, prior to any coming into play of the operation, the subject could be denominated, in so far as this term has a sense and precisely for reasons to which we will return, that one cannot in any way isolate it as subject; and mythically we will call it today the subject of jouissance. For, as you know - I wrote it the last time, I believe - the three stages to which they correspond the three moments of this operation are jouissance, anxiety and desire respectively. It is into these stages that I am going to advance today to show not the mediating, but the median, function of anxiety between jouissance and desire.

How could we comment again on this important moment of our presentation, except by saying the following - the different terms of which I would ask you to take in the fullest sense that can be given them - that jouissance would not know the Other, O, except by this remainder o, which henceforth, in so far as I told you that there is no way of operating with this remainder, and (6) therefore that what comes at the lower stage, is the advent, at the end of the operation, of the barred subject, the subject qua implicated in the phantasy, in so far then as it is one of terms which constitute the support of desire. I say only one of the terms; for the phantasy is s in a certain relationship of opposition to o, a relationship whose polyvalence and multiplicity are sufficiently defined by the composite character of this diamond shape, O, which is just as much disjunction, V./, as conjunction, / ^, which is just as much greater, >, and lesser, <, \$ qua term of this operation has the form of division, since o is irreducible, is unable in this fashion of imaging it in mathematical forms, can only represent the remainder, that if division were carried out, further on, it would be the relationship of o to S which would be involved in the

$$\$: \frac{o}{S}$$

o	Ⓢ	<u>Jouissance</u>
<u>o</u>	∅	Anxiety
\$		Desire

What does that mean? That to outline the translation of what I am designating in this way, I could suggest that o has taken on a sort of metaphor-function of the subject of jouissance. It would only be so, it would not be correct except in the very measure that o is assimilable to a signifier: and precisely, it is what resists this assimilation to the function of signifier. It is indeed for that reason that o symbolises what in the sphere of the signifier is always what presents itself as lost, as what is lost to signification. Now it is precisely the residue, this fall, what resists signification, that comes to find itself

constituting the foundation as such of the desiring subject, no longer the subject of jouissance, but the subject in so far as on the path of his search, in so far as he enjoys (il jouit), which is not the search for his jouissance, but it is to want to make this jouissance enter the locus of the Other, as locus of the signifier, it is there on this path that the subject precipitates himself, anticipates himself as desiring.

Now, if there is precipitation, anticipation here, it is not in the sense that this step skips over, goes more quickly than its own stages. It is in the sense that it approaches, on this hither side of its realisation, this gap between desire and jouissance; this is where anxiety is situated. And this is so (7) sure that the moment of anxiety is not absent, as is marked by this way of ordering the terms, in the constitution of desire, even if this moment is elided, not locatable in the concrete, it is essential. I would ask you, for those to whom I need here to suggest an authority for them to have confidence that I am not making any mistake here, to remember in this connection what in the analysis of "Ein Kind wird geschlagen", in the first not only structural but finalist analysis of phantasy given by Freud, Freud for his part also speaks precisely about a second moment, always elided in its constitution, elided to such an extent that even analysis can only reconstruct it. Which is not to say that this moment of anxiety is always so inaccessible at many levels that are phenomenologically locatable. I said anxiety qua intermediary term between jouissance and desire, in so far as it is having gone through anxiety, founded on the moment of anxiety that desire is constituted.

It remains that the rest of my discourse was constructed to illustrate something which had been perceived for a long time, that at the heart of - we do not know how to take full advantage when it is a question for us of understanding to what there corresponds something that in our experience as analysts takes on a different value, the complex of castration - that at the heart, I was saying, of the experience of desire, there is something which remains when desire is "satisfied", that which remains, as one might say, at the end of desire, an end which is always a false end, an end which is always the result of a mistake.

The value taken on by, something you will allow me to telescope in what I sufficiently articulated the last time in connection with detumescence, namely what is manifested, what is represented of this function of the remainder, by the phallus in its exhausted stage. And this synchronic element which is as stupid as a cabbage, or even a cabbage-stalk, as Petrone puts it, is there to remind us that the object drops from the subject essentially in his relation to desire. That the object should be in this drop, is a dimension that must essentially be emphasised to take this further little step to which I want to lead you today, namely what could, with a little attention, already have appeared to you the last time in my discourse, when I tried to show you the shape in which there is incarnated this object o of the phantasy, support of desire.

Did it not strike you that I spoke to you about the breast or the eyes, making these objects o start from Zurbaran, from Lucy and Agatha, where they present themselves under what I might call a (8) positive form? These breasts and these eyes that I showed you there on the plate on which the two worthy saints carry them, or even on the bitter soil where Oedipus' feet carry him, appear here with a sign different from the one I showed you subsequently in the phallus as specified by the fact that at a certain level of the animal order jouissance coincides with detumescence, pointing out to you that there is nothing necessary about this, necessary nor linked to the Wesenheit, the essence of the organism, in the Goldsteinien sense of the word.

At the level of o, it is because the phallus, the phallus in so far as it is, in copulation, not alone the instrument of desire, but an instrument functioning in a certain fashion, at a certain animal level, it is for this reason that it presents itself in the position o with a (-) sign.

This is essential to articulate clearly, to differentiate, something that is important here, from castration anxiety, from what functions in the subject at the end of an analysis when what Freud designates as a castration threat is maintained there. If there is something which allows us to put our finger on the fact that this is a point that can be gone beyond, that it is absolutely not necessary that the subject remains suspended when he is a male at the castration threat, suspended, when she is of the other sex at Penisneid, it is precisely this distinction. To know how we could go beyond this limiting point, what must be known, this is why an analysis guided in a certain direction culminates at this impasse through which the negative which marks the physiological functioning of copulation in the human being finds itself promoted to the level of the subject in the shape of an irreducible lack. This is what will be found again subsequently as a question, as a direction of our path, and I think it is important to have marked it here.

What I subsequently contributed during our last meeting, is the articulation of two very important points concerning sadism and masochism, the essential of which I resume here for you, the essential that it is altogether capital to maintain, to sustain, in so far as by holding onto it, you can give their full meaning to the very elaborated things that are said in the current state of things about what is involved, namely sadism and masochism. What is to be retained in what I enounced there concerns at first masochism, as regards which you can see that, if the authors have really laboured a great deal to the point of taking very far, so (9) far that something I read recently here, was able to surprise me myself, I will mention later an author who took things to my surprise, I must say to my joy also, as close as possible to the point that I will attempt this year, from our own angle here, to lead to you as regards masochism. • The fact remains that this very article, whose title I will give you later, remains, like all the others, strictly incomprehensible for the simple reason that already at the beginning there is in a way elided, because it is there indeed absolutely under his nose, as one might say,

from the evidence, something that I am going to enunciate in a moment. People try, people manage to avoid putting the accent on that which, at first approach, involves, collides most with our finalism, namely the intervention of the function of pain. This, people have managed to understand, is not the essential thing.

Also people have succeeded, thank God, in an experience like that of analysis, in seeing that the Other is aimed at, that in the transference one can perceive that these masochistic manoeuvres are situated at a level which are not without a relationship to the Other.

Naturally many other authors take advantage of it to go no further, to jump on an insight whose superficial character can be seen at a glance, however handy it has shown itself to be in certain cases. For having only arrived at this level, one cannot say that the function of narcissism, which an author who is not without a certain talent for presentation, Ludwig Heidelberg, has emphasised, is something that can suffice for us. This is what, without at all having made you penetrate for all that into the structure - as we will be led to do - of masochistic functioning, what I wanted simply to stress the last time, because what the light which illuminates the details of the table in a completely new way, is to remind you of what is given apparently immediately - this is why it is not seen in the masochist's perspective, in the most banal approach to these perspectives - that the masochist is aiming at the jouissance of the Other; and what I stressed the last time as another term of that for which I intend to put forward everything that will allow there to be undone, as one might say, the manoeuvre which is hidden by this idea, is that what he is aiming at, what he wants, this of course being the eventual term of our research, of which he can only be fully justified by a verification of the moments which prove that it is the final term, the last term is what he is aiming at, the anxiety of the Other.

(10) I said other things that I intend to remind you of today, it is the essential of what is irreducible in it that you must retain, at least until you can make your judgement on what I have organised around it.

On the side of sadism, with an entirely analogous remark, namely that the first term is elided and that it has nevertheless the same obviousness as on the side of masochism, what is aimed at in sadism in all its forms, at all its levels, is something which also promotes the function of the Other, and that precisely there what is open to view is that what is sought is the anxiety of the Other, just as in masochism, what is masked by that, is, not at all, by an inverse process of reversal, the jouissance of the Other - sadism is not the reverse of masochism for the simple reason that they are not a reversible couple, the structure is more complex, I insist on it, even though today, I am only isolating two terms in each; to illustrate if you wish what I mean, I would say that, as you might assume after several of my essential schemas, they are functions with four terms, they are if you wish squared functions, and that the passage from one to

the other is carried out by a rotation of a quarter of a turn and not by any symmetry or inversion.

You do not see this appearing at the level that I am now designating for you. But what I pointed out to you the last time is hidden behind this search for the anxiety of the Other, is in sadism the search for the object o. It is to this that I brought as a reference, an expressive term taken from Sadean phantasies "the skin of the cunt". I will not recall for you now this text from Sade's work.

We find ourselves therefore between sadism and masochism in the presence of that which at the second level, at the level hidden from the perspective of each one of these two tendencies, is presented as the alternation, in reality the reciprocal occultation of anxiety in the first case, of the object o in the other (sadism).

I will end with a brief reminder which returns to what I already said precisely about this o, this object, namely the emphasising of what I could call, essentially, the manifest character that we know well, even though we do not perceive its importance, the manifest character with which is marked what? The mode in which there enters this anatomy which Freud is wrong to say without any further precision, is destiny.

(11) It is the conjunction between a certain anatomy, the one that I tried to characterise for you the last time at the level of the object o by the existence of what I called the caduques, namely precisely what exists at only a certain level, the mammal level, among the organisms, the conjunction between the caduques and something which is effectively destiny, namely the agalma, through which jouissance has to confront itself with a signifier, namely the mainspring of the limitation to which in the case of man the destiny of desire is submitted, namely this encounter with the object in a certain function, in so far as this function localises him, precipitates him onto this level which I called that of the existence of caduques and of everything which can serve as caduques, a term which will help us among others to explore better, I mean to hope to give an exhaustive catalogue and limit of the frontiers, the moments of cutting, where anxiety can be expected, and to confirm that it is indeed there that it emerges.

Then, I ended, I remind you, by one of the best known clinical examples with a reminder of the close connection, to which we will have to return, and which because of this fact is much less accidental than is believed, the conjunction, I am saying, between orgasm and anxiety in so far as both the one and the other together can be defined by an exemplary situation, the one that I defined in the form of a certain expectation of the other - and of an expectation which is not an indifferent one - the one that, in the shape of a blank page or not, the candidate must hand up at a particular moment is an absolutely gripping example of what can be for him for an instant the o.

After all these reminders, we are going to try to advance a little further. I will do it along a path which is not perhaps, as I said, quite the one that I would have determined on of my own accord. You will see later what I mean by that. There is something that I pointed out to you in connection with counter-transference, namely how women seem to be more at ease in the area. Have no doubt about it: if they are more at ease about it in their writings, theoretically, it is because I presume, they do not manage it too badly either in their practice, even if they do not see, do not articulate - for on this after all why not credit them with a little mental restriction - if they do not articulate its mainspring in a very obvious and clear fashion.

(12) What is at stake here obviously is to attack something which is of the order of the relationship (ressort) of desire to jouissance. Let us note at first the fact that it seems, if we refer to some works, that women understand very very well what the desire of the analyst is. How does that happen? It is certain that we have to take things up here again at the point that I left them with this table, by telling you that anxiety is the middle term between desire and jouissance. I will put forward here some formulae that I will leave each of you to find your way about in from your own experience; they will be aphoristic. It is easy to understand why. On a subject as delicate as the still undecided one of the relationships between man and woman, to articulate everything that could render licit, justify, the permanence of a necessary misunderstanding, could not avoid having the altogether degrading effect of allowing each one of my listeners to drown his personal difficulties, which are very much on this hither side of what I am going to aim at here, in the assurance that this misunderstanding is structural.

Now, as you will see if you know how to listen to me, to speak about misunderstanding here is not at all equivalent to speaking about a necessary failure. I do not see why, if this real is always implicated, the most effj.cacious jouissance could not be reached along the very paths of misunderstanding.

From these aphorisms then, I will choose, I would say strongly - the only thing that distinguishes the aphorism from doctrinal development is that it renounces a preconceived order - I would advance here some forms. For example this one which may speak to you in a fashion, as one might say, less likely to have you rolling about laughing, this formula that only love allows jouissance to condescend to desire. We will put forward some others also which are deduced from our little table where it is shown that o as such, and nothing else, is the access, not to jouissance, but to the Other, that it is all that remains, from the moment that the subject wants to make his entry there, into that Other. The following finally, to dissipate, it seems, to the final term, this term, this poisonous ghost from the year 1927, of oblativity invented by the grammarian Pichon - God knows that I recognise the merit of his grammar - regarding whom one cannot regret too much that what one might call an absent analysis, left him entirely in the presentation of psychoanalytic theory, left him entirely captured in the ideas that he

previously had and which were none other than Maurrasian ideas.

When S reemerges from this access to the Other, it is the unconscious, namely this, the barred Other, O , as I told you earlier, all that remains to him is to make of O something of which it is less the metaphorical function which is important than the dropping relationship in which he is going to find himself with respect to this o .

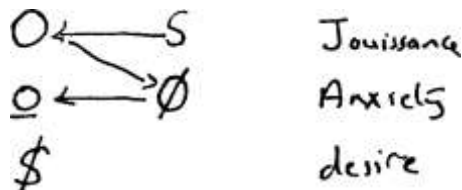

To desire the Other, O , then, is never anything but to desire o . It remains, since it is from love that I began in my first aphorism, that to treat of love, as to treat of sublimation, it must be remembered what the moralists before Freud - I am speaking of those of the good tradition, and specifically of the French tradition, the one which passes, into what I called its scansion in "The man of pleasure" - what the moralists had already fully articulated, and whose acquisition it would be well for us not to consider as out of date, that love is the sublimation of desire. From this it results that we cannot at all make use of love as first or of final term. However primordial it may present itself to be in our theorisation, love is a cultural fact; and as La Rochefoucauld well articulated it, it is not simply "how many people would never have loved if they had never heard speak of love", it is: there would be no question of love if there were no culture.

This ought to encourage us to pose elsewhere the arches of what we have to say concerning - because this is what is involved, at this point that Freud himself says it, underlining that this detour could have been produced elsewhere, and I will come back to why I am doing it now - therefore we have to pose differently the arches of this subject of the conjunction between man and woman. I continue my aphoristic way.

If we have to refer to desire and to jouissance we will say that, to put myself forward as desiring, eron, is to put myself forward as lack of o , and that what must be sustained in our account is the following, the fact is that it is along this path that I open the door to the jouissance of my being. The aporic character of my position, I think, cannot fail to appear to you, nor to escape you. But there are a few more steps to be taken. The aporic character, do I even need to underline it in passing, I will come back to. For I think that you have already grasped, because I told you it a long time ago, that if it is at the level of eron that I am, that I open the door to the jouissance of my being, it is quite clear that the closest decline which presents itself to this enterprise, is that I should be appreciated as eronemos, namely as lovable, something which without fatuousness does not fail to happen, but in which there can be already read that something has gone wrong in the business. This is not

(14) aphoristic, but already a commentary. I thought I ought to give it for two reasons: first of all because I made a kind of little lapse by using a double negation, which ought to warn me of something, and secondly, I thought I glimpsed the miracle of incomprehension shining on certain faces.

I continue. Every exigency for o along the path of this enterprise, let us say, since I have taken the androcentric perspective, of encountering a woman, cannot but unleash the anxiety *o2* the other, precisely because of the fact that I no longer make her anything but o, that my desire o -'s her, as I might say. And here, my little circuit of aphorisms bites its own tail: this indeed is the reason why sublimation-love allows jouissance, to repeat myself, to condescend to desire.

What noble propositions! You see that I am not afraid of the ridiculous. This may sound a little bit like preaching to you, which is obviously something one cannot fail to run the risk of every time one ventures onto this terrain. But it seemed to me that all the same you are taking your time to have a good laugh. I can only thank you for it and I start off again.

I will only start off again today for a brief moment. But allow me again to take a few small steps: because it is along the same path with an air that has, like that, for you a little appearance of heroism that we can advance in the opposite direction, by noting very curiously once more, confirming the non-reversibility of their journeys, that you are going to see arising something which will appear to you perhaps to have a less conquering tone.

What the Other necessarily wants along this path which condescends to my desire, what he wants even if he does not know at all what he wants, is nevertheless necessarily my anxiety. For it is not enough to say that the woman, to name her, overcomes her's by love. We will return to it, we will have to see.

Let us proceed along the path that I chose today. I still leave to one side - this will be for the next time - how the partners are defined at the beginning. The order of things in which we are involved always implies that it should be so, that we should take things up en route, and even occasionally at the arrival; we cannot take them up at the start.

In any case, it is in so far as she wants my jouissance, namely to enjoy me - this can have no other meaning - that the woman (15) stirs up my anxiety, and this for the very simple reason inscribed for a long time in our theory; the fact is that there is no desire realisable on the path that we are situated on unless it implies castration. It is in the measure that jouissance is involved, namely when she is aiming at my being, that the woman can only reach me by castrating me. Let this not lead you - I am speaking to the masculine part of my audience - to any resignation as regards the always manifest effects of this primary truth in what is called in a classificatory term conjugal life. For the definition of a primary ananke has absolutely

nothing to do with its accidental incidences. It nevertheless remains that one clarifies many things by articulating them properly. Now to articulate as I have done, even though it overlaps experience in the most manifest fashion, is precisely what runs the danger that I have signaled on many occasions, namely that one sees what is called in common language a fatality, which means that it is written down. It is not because I say it - that you must think that it is written down. Moreover if I wrote it I would put more shape on it; and this shape would consist precisely in entering into detail, namely in giving the why.

Let us suppose - something which is obvious - that with reference to what I made the key of this function of the object of desire, the woman - which is quite evident - does not lack anything. Because one would be completely wrong to consider that Penisneid is a final term. I told you already that this would be the originality on this point of what I am trying to advance before you this year.

The fact that she has nothing to desire on this point - and perhaps I will try to articulate very very precisely why anatomically; for this affair of the clitoris-penis analogy is far from being absolutely grounded: a clitoris is not simply a smaller penis, it is a part of the penis, it corresponds to the cavernous bodies and to nothing else; now, a penis, as far as I know, except in the case of hypospadias, is not limited to the cavernous bodies; this is only a parenthesis - the fact of having (16) nothing to desire along the path of jouissance does not absolutely settle for her the question of desire, precisely in the measure that the function of o for her as for us plays its full role. But all the same, this question of desire, simplifies it a lot; I mean for her; not for us; in the presence of their desire. But after all to interest themselves in the object as object of our desire, creates far fewer complications for them.

Time is passing. I am leaving things at the point that I was able to bring them to.- I think that this point is sufficiently tempting for many of my listeners to want to know what comes next.

To give you some foretaste of it, to announce to you the fact that I intend to bring things to the level of the function of the woman, in so far as it may allow us to see further at a certain level in the experience of analysis, I will tell you that, if a title can be given to what I will enunciate the next time, it would be something like "The relationship between the woman as analyst and the position of Don Juan".

Seminar 15: Wednesday 20 March 1963

Today we are going to move forward. We will try to articulate why, in order to situate anxiety for you, I am led, I announced that I will have to deal with this central field, already outlined in the Seminar on Ethics, as being that of jouissance. You already know through a certain number of approaches, and specifically the one that I made that year, that it is necessary to conceive of this jouissance so mythically, that we ought to situate its point as profoundly independent of the articulation of desire, because desire is constituted on this hither side of the zone which separates jouissance and desire from one another and which is the break (la faille) where anxiety is produced.

It is understood of course - and I said enough about it for you to sense it - that I am not saying that desire in its status does not concern the real other, the one who is involved in the jouissance; I would say that it is normative that desire does not concern this other, that the law which constitutes it as desire does not manage to concern it in its centre, that it only concerns it eccentrically and to one side, o substitute for O.

And therefore all the Erniedrigungen, all the degradations of love life punctuated by Freud which come to emerge, are the effects of a fundamental irreducible structure. This is the gap that we have no intention of masking, though on the other hand we think that the castration complex and Penisneid which flourish here, are not themselves the final terms for designating it.

This domain, the domain of jouissance, is the point where as I might say, the point thanks to which woman proves herself to be superior precisely in this, that her link to the knot of desire is much looser. This lack, this "minus" sign, with which the phallic function is marked for man, which means that for him his liaison to the object must pass by this negating of the phallus by the castration complex, this necessity which is the status of the **(-p)** at the centre at man's desire, is something which for the woman is not a necessary knot.

This does not mean that she is for all that without a relationship to the desire of the Other; but precisely, it is indeed with the desire of the Other as such that she is in a way affronted, confronted. It is a great simplification that, as regards this confrontation, this phallic object only comes second

for her and in so far as it plays a role in the desire of the Other.

(2) This simplified relationship with the desire of the Other, is what allows the woman, when she works in our noble profession, to be with respect to this desire in a relationship which, it must be said, is manifested each time she approaches this field designated in a confusing way as that of counter-transference, in a relationship which we sense is much freer, this of course notwithstanding each particularity that she may represent in what I might call an essential relationship.

It is because, in her relationship to the Other, she does not hold to it as essentially as the man, that she has this greater freedom essentially, Wesentlich. What does that mean in a particular case? That means she does not hold to it as essentially as man does as regards the nature of jouissance.

And here I cannot avoid having to remind you, along the same line as that which the other day I incarnated for you at the level of the fall (chute) of Oedipus' eyes, that Tiresias, the seer, who ought to be the patron of psychoanalysts, was blinded, by an act of vengeance of the supreme goddess, Juno, the jealous one; and as Ovid explains very well to us in the third book of the Metamorphoses, from verse 316 to verse 338 - I would ask you to consult this text of which Mr T S Eliot in a note to The Wasteland underlines what he calls the very great anthropological interest - if Tiresias offended Juno, it is because, consulted like that, for a joke - the Gods do not always measure the consequences of their acts - by Jupiter who for once was having a relaxed relationship with his wife and teasing her about the fact that undoubtedly "the pleasure that you experience is greater" - he is the one who is speaking - "than that experienced by the man". But then he says: "But, by the way, what am I thinking of? Tiresias was a woman for seven years". Seven years, every seven years - the baker's wife changed her skin, sang Guillaume Apollinaire - Tiresias changes sex not by simple periodicity, but because of an accident: he met the two coupling snakes, the ones we see in our caduceus, and he was unwise enough to disturb their coupling. We will leave to one side the meaning of these snakes that one cannot unknot without running such great danger. It is by renewing his attempt that he also rediscovers his first position, that of a man.

(3) In any case, for seven years he was a woman. This is why he can testify before Jupiter and Juno, that whatever might be the consequences he must testify to the truth and corroborate what Jupiter says: it is women who enjoy (jouissent).

Their jouissance is greater, whether it is a quarter or a tenth more than that of the man - there are more precise versions. The proportion does not matter much because it only depends, in short, on the limitation his relationship to desire imposes on man, namely what I am designating as situating the object for him in the negative column, the (-\$>) . Contrary to what the prophet of absolute knowledge teaches this man, namely that he makes his

hole in the real, which is called negativity in Hegel, what is involved is something else: the hole begins at the bottom of his belly, at least if we want to remount to the source of what constitutes for him the status of desire. Obviously it is here that a post-Hegelian Sartre, with what I would call his marvellous talent for misleading, has slipped in his own image, the one that you know well, the image of the little child that he makes a born bourgeois for us, as a way naturally of giving flavour to the affair, who sticks his finger into the sand of the beach, mimicing in his eyes and for our intention an act which is supposed to be the fundamental act. Of course starting from there a well-deserved derision can be exercised against the pretention of this new shape that we have given to the little man which is in man, namely that now we incarnate this little man in the child, without noticing that the child deserves all the philosophical objections that were made against the little man.

But after all beneath this figure in which Sartre represents it for us, it works, because what does it make resonate in the unconscious? Well then, by God, nothing other than this engulfment into the womb of mother earth desired by his whole body, whose meaning Freud unveils in a proper sense when he says textually at the end of one of the chapters of Hemmung, Symptom und Angst that the return to the maternal womb is the phantasy of someone who is impotent [cf SE XX 139].

Thus the orphan child that Sartre tries to hatch out in this man and whom through all his work, he urges to share the only glue of existence, will allow itself to be this phallus - the accent here is on the to be - the phallus that you can see by incarnating it in an image which is within the range of your research, the one that is found hidden in the valves of these little animals that are called razor fish and if that is lacking in your experience, (4) I hope that all of you have been able to see them on occasion suddenly .sticking out their tongues at you in the soup tureen where you put those you have collected, a procedure carried out the way you collect asparagus with a long penknife and a simple length of wire that one hooks under the sand.

I do not know whether you have all seen that already, in the opisthotones, these tongues emerging from the ra-zor back; in any case it is a unique spectacle that you should treat yourself to if you have not already seen it, and whose relationship appears to me quite obvious with this phantasy, on which you know Sartre insists in La Nausee, of seeing such tongues dart out suddenly from a wall or from any other surface, this according to the thematic that rejects the image of the world into an unfathomable facticity.

Well then, one might ask: "So what?" I do not believe that in order to exorcise the cosmos - because when all is said and done that is what is involved; it is to undermine, after the fundamental terms of theology, the cosmology which is of the same nature of course - I do not believe that it is this curious usage of tongues which is the right path, but much more rather than to

believe it to be, like earlier, essentially redoubled by Wesentlich - and I would like to have been able to score it for you in many others - I find myself in a Babel-like atmosphere which will end up, if I am roused, by making it one of the key points of what I have to defend.

In any case, this reference indicates to you why my own experience of what one sees on the beach, when one is a small child on the beach, where one cannot make a hole without water rising up in it, well then, to be frank, it is an irritation which also rises - but in me - at this oblique approach of a crab always ready to hide his intention of pinching your fingers.

A crab is very skillful! You could give him a pack of cards to shuffle - it is much less difficult than opening a mussel, which is something he does every day - well then, even if there are only two cards, he will always try to mix them up.

So it is said for example: the real is always full. That has an effect, that sounds a little bit like what is said here which lends credence to it, that of a genuine Lacanism. Who speaks like that about the real. I do.

The problem for me, is that I never said that. The real is full of holes and one can even make a vacuum in it. What I say, is that it does not lack anything, which is quite different.

(5) I added that if you makes pots, even if they are all the same, it is quite certain that they are different pots. It is even quite extraordinary that, under the name of the principle of individuation, this still gives just as much trouble to classical thought.

Look where we are still at in Bertrand Russell: to sustain the distinction between individuals, it is necessary to mobilise the whole of time and space, which, you must admit-, is a real joke.

The next phase for my pots, is that the identity, namely what is substitutable between the pots, is the void around which the pot is made. The third phase is that human action began when this void was barred, to be filled with what is going to constitute the void of the pot next to it, in other words when to be half full is the same- thing for a pot as to be half empty, in other words when it is not leaking all over the place.

And in every culture, you can be sure that a complete civilisation already obtains when there are the first ceramics.

I sometimes contemplate in my house in the country a very beautiful collection that I have of vases. Obviously, for these people, at that time, as many other cultures bear witness, it was their principal wealth; but in these vases, obviously, even if we cannot read what is magnificently, luxuriously, painted on their sides, translate it into an articulated language of rituals and myths, we know that in these vases there is everything, that this is enough, that the

relationship between man and the object and desire is here completely tangible and surviving.

This is what moreover, to take a step backwards, legitimises this famous mustard pot which made one of my colleagues gnash his teeth for more than a year to the point that I, nice as I always am, ended up by putting it back on the shelf with the pots of glue, even though, as I told him from the beginning, this mustard pot served me as an example, by the fact that it is - you know well, it is something striking in experience - that on the table it is always empty, that there is never any mustard except when it gets up your nose.

There we are! Now this having been said, it remains that on the usage of these pots, since recently there was posed for us a problem of this order, I am not looking at all as you might think at Piera Aulagnier, who is a clear-headed person in the way that women know how to be - and that is even what she is blamed for - knows very well that it is allowable to put the label "gooseberry jam" on the pot which contains the rhubarb. It is enough to know (6) what one wants to purge by this means and wait to collect what one wanted from the subject.

All the same, when I bring you here batteries of tarted-up pots - for do not believe that it is ever without having broken a lot of them; I also, in my time, gave whole discourses in which the action, the thought, the word, did the rounds in a way that made symmetry stink, well then, it has been thrown in the waste paper basket.

When I put impediment on top of the column which contains acting-out, embarrassment at the top of the next one which contains the passage a l'acte, if you wish, Piera, to distinguish the cases of acting-out that you have so carefully observed, if you wish to distinguish it as being what you call transference in act (transfert agi) - which is of course a distinct idea of your own, which deserves discussion - it nevertheless remains that it is to my table that you refer since you invoke in the text the embarrassment that your subject found himself in. And since this term is scarcely used outside of this place, it is here that you have noted it down.

Now it is manifest in the observation that the patient had been impeded by the midwife from attending the birth of his offspring, outside the maternal gates, and it is the dismay of being incapable of overcoming a new impediment of this order which threatens him, which precipitates him to throw the police into anxiety by the written claim of the right of the father to what I would call illiophagia, to specify the notion which is there to represent the image of the devouring of Saturn: because after all it is written in this observation that this gentleman presents himself at the police station to say that there is nothing in the law which impedes him from eating his baby who had just died. On the contrary it is obviously the embarrassment into which he is plunged on this occasion by the calmness of the policeman - who did not come down in the last shower - and the shock of the

dismay that he wanted to provoke which makes him act impulsively] (passer a l'acte), with acts of a kind that have him put in prison.

So then, not to recognise, when obviously you are involved, that I could not find a better observation to explain what you know, that you are really involved, that you have put your finger on it, this is a certain betrayal of yourself, which of course could not be reproached to a person when what is involved is handling something like that which has been freshly minted. One could well put a little in it. But this all the same authorises me to recall that my own work is only of interest when it is properly used - this is not addressed to you, Piera, it is (7) not a matter of using it, as people have got into the habit, the bad habit of doing with respect to notions which are in general grouped together in teaching in a sort of collecting together which is only done for decoration. Having recalled this about what gives you the right to watch over what I bring you, what I have chosen for you with so much care, I take up my remarks again.

And to come to the woman, I also am going to try with one of my observations, to make you sense what I mean as regards her relationship to jouissance and to desire.

Here then is a woman who one day - the coordinates of longitude and latitude - remarks to me that her husband, whose insistence, as I might say, is the foundation of their marriage, has abandoned her for a little too long a time for her not to notice it. Given the way that she always receives what she senses from him as being more or less clumsy, this is rather a matter of relief to her.

Nevertheless, I am all the same going to extract a sentence in which - do not rush immediately to smell an irony which it would be quite wrong to attribute to me - she expresses herself as follows: "It does not matter to me whether he desires me or not, provided he does not desire someone else".

I would not go so far as to say that this is the common or the regular position. This can only take on its value from what follows ^{ixi} the constellation as it is going to be unfolded by the associations which make up this monologue. Here then she is going to speak about her own state, she speaks about it - one swallow does not make a summer - with a particular precision. Tumescence not being the privilege of the man, I think, I am not surprised that she, who has a quite normal sexuality - I am speaking about this woman - should testify, should say that, if for example when she is driving something alarms her which moves her say: "Good God! a car!", well then, inexplicably, this is what strikes her that day: she becomes aware of the existence of a vaginal swelling which she notes as responding at certain times to the sudden emergence in her field of any specific object whatsoever which in appearance is quite foreign to sexual images or space. This state, she says, which is not disagreeable, but rather inconvenient in its nature, goes away by itself.

At that point, she says, it bothers me to link up with what I am going to tell you, because of course it is not related. She tells me then that every one of her initiatives is dedicated to me, to myself. "I say it is" - I think you have understood for a some time: I am her analyst - "I cannot say consecrated, that (8) would mean doing it with a certain aim. No, any object whatsoever obliges me to evoke you as a witness, not even to have the approval of what I see. No, simply the look. In saying that, I am even going a little too far. Let us say that this look helps me to get its meaning from everything."

At this point, the ironic evocation of the theme encountered at a younger stage of her life, of the well-known title of the play by Steve Fasseur "Je vivrai un grand amour". Had she experienced at other moments of her life this reference to the other? This made her refer back to the beginning of her married life, then go further and testify in effect to the one who had been in effect, the one who is never forgotten, her first love.

It was a student from whom she was quickly parted, with whom she remained in correspondence in the full sense of the term. And everything that she wrote to him, she says, was really "a tissue of lies".

"I created a character bit by bit, what I wanted to be in his eyes, and what I in no way was. It was, I fear, a purely romantic enterprise which I pursued in the most obstinate way". To envelop myself, she says, in a kind of cocoon. She adds very gently: "You know, it was not easy for him to get over it..... "

At this point, she comes back on what she does with reference to me personally: "What I am striving to be here is the complete opposite: I try always to be true with you. I am not writing a novel when I am with you; I write it when I am not with you" . She returns to the weaving, always thread by thread, of this dedicating of every gesture which is not necessarily a gesture which she thinks would please me, nor even one which is necessarily one that agrees with me. It cannot be said that she forces her talent. What she wants after all, is not so much that I should look at her, it is that my look should come to substitute for her own: "It is the help of yourself that I summon. My own look is not enough to capture everything that is to be absorbed from the outside. It is not a matter of watching me doing something, it is a matter of doing something for me."

In short, I will finish here with something that I still have a large page on from which I only wish to extract the only word of bad taste which occurs on this final page:

"I am," she says, "operated by remote control, which is not in any way a metaphor, believe me. There is no feeling of being influenced. But if I make use of this formula, it is in order to remind you that you may have read in the papers about this left- (9) wing figure who after being conned in a bogus assassination attempt, thought he ought to give this immortal example that in politics the left is in effect always remotely controlled

by the right. This is the way moreover that a strict relation of parity can be established between these two parts."

So then where does all of this lead us? To the vase, to the feminine vase: is it empty, is it full? It does not matter, since even if it is, as my patient says, to be consumed stupidly, it is sufficient in itself. It lacks nothing. The presence of the object there is, as one might say, an addition. Why? Because this presence is not linked to the lack of the object cause of desire, to the ^{to} which it is linked in man. The anxiety of man is linked to the possibility of not being able, hence the myth which makes of the woman - it is a completely masculine myth - the equivalent of one of his ribs: this rib has been taken out of him, it is not known which one, and moreover, he is not missing any of them. But it is clear that in the myth of the rib what is involved precisely is this lost object, that woman for man is an object who is made with that.

Anxiety exists in the woman also. And even Kierkegaard, who must have had more of the nature of Tiresias probably than I have - I am fond of my eyes - Kierkegaard says that the woman is more open to anxiety. Must we believe this? In truth what is important for us, is to grasp its link to what we can call the infinite, indeterminate possibilities of desire around her in her field. She tempts herself in tempting the other, which is a way that the myth can also be of use to us here. After all, anything can be used to tempt him, as the complement of the earlier myth shows, the famous history of the apple; any object whatsoever, even one that is superfluous for her. For after all, what is she doing with that apple? She does not know what to do with it any more than a fish would. But it happens that this apple is already good enough to hook for her the little fish, to hook the fisherman on the line. It is the desire of the other which interests her. To put the accent a little bit better, I would say that it is the price of this desire in the market - for desire is a mercantile thing: there is a share listing of desire which rises and falls culturally - it is on the price that one gives to desire on the market that there depends at every moment the style and the level of love.

In so far as it itself is a value, as the philosophers put it very well, it is from the idealisation of desire that it is made up. I say the idealisation, for it is not at all as a sick (10) person that our patient earlier spoke in this way about the desire of her husband. That it is important to her is love. That it is not all that important for him to manifest it is not necessary, but it is in the order of things.

In this respect, experience teaches us that in the jouissance properly speaking of the woman, which merits - and it is perhaps a good thing - there being concentrated on her all sorts of attentions from her partner, the impotence, properly speaking, the technical mistakes, the impotence of this partner may be very well accepted. And this can also be seen when a fiasco occurs, as Stendhal pointed out to us a long time ago, that in the

relationships where this impotence is long-lasting, and where it seems that if on occasion, after some time, one sees the woman taking to herself some assistant with a reputation for being more efficacious, this is rather through a kind of shame, so that it will not be said that she is being refused it, for whatever reason.

In passing, I remind you of my formulae about masochism that I gave the last time. They are designed, as you will see, to restore to masochism, whether it is the masochism of the pervert, or moral masochism, or feminine masochism that is involved, a unity that is otherwise difficult to grasp. And you will see that feminine masochism takes on a quite different, rather ironic, meaning if this relationship of occultation in the other of the alleged, apparent jouissance of the other, the occultation by this sort of jouissance of the other of an anxiety which it is undoubtedly a question of awakening.

This gives to feminine masochism a quite different import which can only be laid hold of by clearly grasping first what must be posited at the beginning, namely that it is a masculine phantasy.

The second thing, is that in this phantasy in short, it is by procurement and in relation to this structure imagined in the woman, that man makes his jouissance be sustained by something which is his own anxiety, something which overlaps for man the object and the condition of desire. Jouissance depends on this condition. Now desire for its part, only covers anxiety. You see then the distance that remains for it to travel to have jouissance within its range. For the woman, the desire of the other is the means for what? For her jouissance to have what I might call an appropriate object! Her anxiety is only before the desire of the other which she does not know very clearly when all is said and done what it covers. And to go further in my formulae, I would say that because of this fact in the kingdom of the man there is always some imposture present.

(11) In that of the woman, as we already said at one time - remember the article by Joan Riviere - if something corresponds to it, it is the masquerade; but it is something quite different. Woman in general is much more real and much truer in the fact that she knows what the ell she dealing with in desire is worth, that she passes through this in a very tranquil manner, that she has, as I might say, a certain contempt for her misapprehension, a luxury which the man cannot offer himself. He cannot have contempt for the misapprehension about desire, because it is his quality as a man to prize it. To allow his desire to be seen by a woman is obviously anxiety-provoking in some cases. Why? Because it is to allow there to be seen (laisser voir)- and I would ask you in passing to note the distinction between this dimension of allowing there to be seen compared to the voyeurism-exhibitionism couple, it is not simply to show it and to see it: there is the allowing it to be seen for the woman, for whom at most the danger comes from the masquerade - what is to be allowed to be seen, is what is there of course. If there is not much, it is anxiety-provoking: but it is always what is there, instead of

letting her desire for the man be seen, it is essentially letting there be seen what is not there.

So, you see, that you should not believe for all that that this situation, the proof of which may appear rather complex to you, is to be seen as all that hopeless. If undoubtedly it did not represent it to you as easy, could you ignore in it the access for man to jouissance. It remains nonetheless that this is quite manageable if one is only expecting happiness from it.

This remark being conclusive, we will go into the example which I find myself in short in a position to allow you to take advantage of, from the favour that we all owe Granoff for having introduced it here, namely Lucia Tower.

As I told you: in order to understand what Lucia Tower tells us about two males she was dealing with, I do not believe I can find a better preamble than the image of Don Juan.

I have worked over the question again a good deal these days for you. I cannot make you go through the labyrinth again. Read this appalling book which is called: Die Don Juan Gestalt by Rank; a cat could not find her kittens in it; but if you have -che thread that I am going to give you, it will appear much clearer.

Don Juan is a feminine dream. What is necessary in this case, is a man who is perfectly at ease with himself, who in a certain fashion with respect to men, the woman can pride herself on (12) being, a man to whom nothing is lacking. This is perfectly tangible in the term to which I will have to return in connection with the general structure of masochism, which is that Don Juan - this sounds really banal to say it to you - the relationship of Don Juan to this image of the father, qua uncastrated, namely a pure image, a feminine image.

The relationship can be clearly read in what you find in the labyrinth and in the detours of Rank, that what is involved in Don Juan, if we can manage to, link him to a certain state of myths and of rituals: Don Juan represents, Rank tells us - and here he is following his nose - the one who in olden days is capable of damning a soul without losing his own for all that. The famous jus primae noctis is supposed to be based on this, the existence, which you know is mythical, of the priest who deflowers on the first night, is here in this zone.

But Don Juan is a beautiful story which works and has its effect, even for those who do not know all its niceties, which undoubtedly are not absent from Mozart's song and which are to be found in the Marriage of Figaro rather than in Don Giovanni.

The tangible trace of what I am putting forward to you about Don Juan, is that the complex relationship of man to his object is effaced for him, but at the price of accepting his radical imposture. The prestige of Don Juan is linked to an acceptance of this imposture. It is always there, at the place of another:

it is, as I might say, the absolute object.

Note that it is not at all said that he inspires desire. If he slips into women's beds, one does not know how he is there. One could even say that he does not have one either, that he is in a relationship with something vis-a-vis which he fulfills a certain function. This something, call it the odor di femina, and that takes us a good way. But desire plays so little part in the affair, that when the odor di femina passes he is capable of not noticing that it is Dona Elvira, namely someone with whom he has supped to the full, who has just crossed the stage.

It has to be said, he is not what for the woman is an anxiety-provoking character. It can happen that the woman really senses herself to be the object at the centre of a desire. Well then, believe me, it is then that she really flees! We are now going to enter, if we can, into Lucia Towers' story.

(13) She has two men - I mean in analysis. By God, as she tells it, she always had very satisfying relations with them from a human point of view.

Do not imagine I am saying that the affair is simple, nor that they do not hold out for a long while. They are two anxiety neurotics. At least that is the diagnosis that she posits, having examined everything carefully.

These two men who have had, as it should be, some difficulties with their mothers, and with what are called "female siblings", which means sisters, but which situates them as being equivalent to brothers, these two men now find themselves intimately acquainted with women, we are told, that they have well and truly chosen in order to exercise a certain number of aggressive and other tendencies, and to protect themselves in this way from a penchant, that by God is not analytically contestable, for the other sex.

"With both men", she tells us, "I was quite aware of the contributions which they themselves made to the difficulties with their wives, namely that both were too submissive, too hostile, in a sense too devoted, and both wives", she tells us - for she enters boldly into an appreciation of the point of view with a lorgnette - "were frustrated for lack of sufficient uninhibited masculine assertiveness from their husbands", a way of affirming themselves as men in an uninhibited way. (cf 240)

In other words - we immediately enter into the heart of the subject, she has her ideas about things - they do not pretend enough. For her part, of course, without knowing what might trap her in this, she herself feels very "protective", a little too "protective" although differently in the case of the first man: she protects, she tells us, his wife a little bit too much, and in the second case him a little bit too much.

In fact, what reassures her, is that she has a much greater attraction for the second, and this - you have to read the things

all the same in their innocence and their freshness - because the first one has all the same some "psychosexual problems" that are not too attractive.

This one, the first one, shows himself in a way which is not all that much distinguished from that of the other. Both really tire her with their mumbling, their halting speech, their circumstantiality - that means they go on and on - their repetitiveness, and minutiae. But after all she is an analyst: what she notices in the first one, is this tendency to attack her own power as an analyst.

The other has a different tendency: for him it is rather a matter of taking an object from her than properly speaking of destroying it as frustrating. And of course in this connection, she says to herself: "Well now, after all, by God, it is perhaps because the second one is more narcissistic."

*In fact this does not hold up, as those who have a little culture can remark, with the other references that we have about narcissism. For on the other hand it is not so much narcissism which concerns him here as what is called the anaclitic aspect, as she will clearly see from what follows.

Moreover on the other hand, she tells us, however long, however fastidious may be the path which is taken with the one and the other without anything showing the efficacy of the analysis of transference, it nevertheless remains that there remains in all of this something which does not have anything fundamentally disagreeable about it, and that in fact all the counter-transference responses that she perceives in herself do not at all, she says, reasonably go beyond this limit where one could say that any female analyst would risk losing her way in connection with such valuable characters if she were not on her guard. She is very specially so. And very especially, she pays attention at what is happening on the side of this woman over whom she watches perhaps a little more specifically: the wife of her first patient. She learns that she has had a little psychosomatic accident. She says to herself: "By God, that's not too bad. Since what I feared, was that she was drifting towards a psychosis, here we have an anxiety that is well bound."

And then she thinks no more about it. She thinks no more about it and the situation continues, namely that one may well analyse everything that happens in the transference, and therefore even the use made of it in his analysis by the patient - I am speaking about the first one that is involved - of his conflicts with his wife, to obtain from his analyst all the more attention, to obtain from her the compensations that he had never found with his mother, still no progress is made.

What is going to release things, make them progress? A dream, she tells us, which happens to her, to her the analyst. A dream in which what happens? In which she sees that perhaps it is not all that sure that things are going so badly for this woman. First of all because in the dream she welcomes her, the analyst,

extremely well, that she shows her in all sorts of ways that she has no intention - this is in the dream - of torpedoing the analysis of her husband - which was one of the presuppositions of the business - and that this woman is therefore prepared to show (15) a disposition that we would call, to translate the atmosphere of the dream, a cooperative one.

This makes our analyst, Lucia Tower, prick up her ears. She understands that there is something to be completely revised. This chap is really someone who in his home really tries to do everything necessary to make his wife more comfortable, in other words, the desire of this gentleman, is in no way as aimless as all that. Our little pal takes himself seriously all the same; there is a way of dealing with him, in other words, he is capable of taking himself for what is at stake, the dignity of which had been refused him up to then: to take himself for a man, to get involved in the game. When she makes this discovery, when she re-orientes her relationship to the desire of her patient, when she perceives that she has miscognised up to now where things were situated, she can really undertake with him a revision of everything that had been played out with her up to then in a deceptive way. The claims of the transference were themselves an imposture. And, she tells us, from that moment on everything changes. But how does everything change and in what sense?

You have to read her to understand that it is at that moment that the analysis becomes something particularly difficult to tolerate. For, she says, from that moment on everything happens in the midst of this storm of depressive movements and of naked rage, as if he were putting me the analyst to the test in each one of my smallest fragments.

If a moment of inattention, she tells us, meant that each one of these little fragments does not sound right, if one of them was sham, I had the feeling that my patient would shatter into pieces.

She herself qualifies as best she can - she does not see everything but she clearly names what she meets up with - that what is involved is something, she tells us, which really belongs to phallic sadism couched in oral language.

What are we going to retain from this? Two things: firstly the confirmation by the very terms that are used of what I designated for you as being the nature of sadism - for the not entirely attractive anomalies of the patient are certainly of this order - that what is sought for in the sadistic search is this little fragment which is lacking in the object: it is the object, and it is a search for the object that is involved in the way in which, once the truth of his desire has been recognised, the patient behaves.

(16) This to show you also that it is in no way masochistic to put oneself in the line through which the search for the sadistic object passes. Our Lucia Tower does not accuse herself of any such thing and we have no need either to impute it to her.

Simply she draws a storm down on herself, and - she underlines it with a particular courage - with respect to a character with whom she only entered into a relationship from that moment when his desire interested her.

She does not conceal that it is in function of the fact that she herself is in a posture of rivalry with the characters of his history and that obviously that his desire was not entirely involved in her, that she supports therefore the consequences of this desire to the point that she experiences this phenomenon that the analysts circumscribe and have called "carry-over", which means report or designate where most obviously one can denote the effects of the counter-transference when you continue to think about a patient when you are with another one. And nevertheless, she tells us, all of this, when I had almost reached the end of my tether, disappeared by chance "amusingly", really in the most amusing and sudden fashion, which means that going on holidays during one of the annual breaks, well, by God, goodness, she notices that nothing remains of this business, this business is of absolutely no interest to her, namely that she is really incarnating in the freest and most airy mythical position Don Juan as he leaves the room where he has committed his usual idiocies.

After this break, her efficacy, her adaptation in this case and, as I might say, the implacable nakedness of her look is very essentially possible in the measure that a relationship which for once is only a relationship to a desire as such, however complex moreover you may suppose it to be - and she indicates that she also has her problems - is never when all is said and done anything but a relationship with which she can keep her distance. It is on this point that I will continue the next time.

Seminar 16: Wednesday 26 March 1963

....[it is] because of our Lucia Tower that I find myself to have taken here as an example, from a certain angle of what I would call the "facilities of the feminine position" - this term facility (facilite) having an ambiguous import - as regards its relationship to desire; let us say that what I formulated consisted in this sort of lesser implication which, as someone in the analytic position, allowed her to reason it out for us, let us say, in her article on "Countertransference", if not more soundly, at least more freely. It is certain, if you read this text, that it is in the measure and through what I would call her "internal self-criticism" she noticed that through the effect of what she calls - here soundly enough - her counter-transference she had neglected something about what one could call the correct appreciation or orientation of the desire of her patient, that, without her properly speaking telling us what she said to him at that moment, because she does not tell us anything, except that she returned once again to the "transference requirements" of this patient, but by straightening things out for him, therefore she was only able in doing this to give him the impression that she was sensitive to what she herself had just discovered, namely that this patient, in brief, was paying great attention to his wife, was more "the manager" of what was happening in the conjugal circle than she had suspected. It seems indeed that because of this - we can only trust her, for this is the way she expresses herself - that the patient is only able on this occasion to translate this rectification in these terms - which are those of Lucia Tower herself - that in short the patient's own desire is much less deprived of a hold on his analyst than he believed, that effectively it is not ruled out that up to a certain point he can make something of this woman who is his analyst, bend her (la courber) - "to stoop" in English; "She stoops to conquer", is the title of one of Sheridan's [Goldsmith's] comedies - bend her to his desire. This at least is what Lucia Tower tells us in her own words. This does not mean of course - she also underlines this - that there is any question even for a moment of this happening; she is, in this respect, as she tells us, very sufficiently on her guard, she is not a baby - indeed, when is a woman one! - in any case "too aware of" - this is the term she uses - she is well and truly on her guard. But that is not where the question lies. Through this intervention, this rectification which appeared to

the analysand here as a concession, as an opening out, the desire of the patient is truly put back in its place; what is really the whole question, is that he had never been able to find this place. This is what his anxiety neurosis is. What she encounters at that moment, is - we said it the last time - this unleashing in the patient of what she expresses, namely: from this moment on, I was subjected to a pressure, which means that I was scrutee, scrutinsee, as they say in English "to scrutinise", in a way that felt to me that I could not make the slightest false move. If it appeared for a single instant that I was not up to responding to what I was being tested on, cell by cell, well then, it is my patient who would fall apart.

Having therefore, for her part, sought the desire of the man, what she encounters as a response, is not the search for her own desire, it is the search for o, for the object, for the true object, for what is involved in desire which is not the Other, O, which is this remainder, this o, the true object.

It is here there lies the key, there lies the accent of what I would like today, among other things, to demonstrate to you. The fact that she sustains this search, this is what she calls herself having more masochism than she had believed. Here - I told you this because she wrote it - you should clearly understand that she is wrong: she is not at all suited to enter into the masochistic dialogue, as her relationship with the other patient, the other male that she fails so well with - as you are going to see - sufficiently demonstrates. She simply holds out very well, even though it is exhausting, that she is able for no more, as I told you the last time, as her vacation approaches, luckily there are vacations, and, as I told you, in a way that is for her as surprising as it is amusing, "amusingly", in its suddenness, suddenly she perceives that after all all of this, once it has stopped, it does not last very long. She gives herself a shake and thinks about something else, why? It is because after all she knows very well that he can always search, that there has never been any question of him finding. This is precisely what is involved: for him to realise that there is nothing to find. There is nothing to be found there, because that which for the man, for male desire in this case, is the object of the search only concerns, as I might say, himself. This is the object of my lecture today.

What he searches for, is the (-0); it is, as I might say, what he is lacking. It is a male or a mens' affair. She knows very well - let me say it and do not get too worked up about it - she knows very well that she is not missing anything or rather - we will return to it later - the mode in which lack operates in female development is not to be situated at this level, at the place that it is sought by the desire of the man when what is involved properly speaking - and this is why I emphasised it at first - is a sadistic search: to make sprout up what ought to be at the place, in the partner, at the supposed place of the lack. This (3) is what he has to give up as lost. I am saying that because in the text she articulates extremely well that what they did together, is this work of mourning. Once he has given up this

search as lost, namely the hope of finding on this occasion in his partner, in so far as she had posed herself, without knowing too well - it has to be said - what she was doing, as a female partner, when he has given up as lost the hope of finding in this partner his own lack, (-\$>), the primary fundamental castration of the man, as I have designated it for you here - you should note - at the level of its biological root, of the particularities of the instrument of copulation at this level of the animal scale, when he has given it up as lost - it is Lucia Tower who tells us this - everything is going to work out well, namely that we are going, with this gentleman who had never up to then reached this level, to be able to enter into what you will allow me on this occasion **zo** call "the Oedipal comedy", in other words we are going to be able to enjoy ourselves: it is Daddy who did all that! Because when all is said and done this is what is involved, as has been known for a long time, remember Jones and the moralisches Entgegenkommen, the concession to moral intervention: if he is castrated, it is because of the law. We are going to play out the comedy of the law, we are much more comfortable there; it is well known and it has been mapped out. In short, we see the desire of our gentleman taking the paths already traced by what? Precisely by the law, demonstrating once more that the norm of desire and of the law are one and the same thing.

Do I make myself sufficiently understood? Not sufficiently, because I have not told you the difference, what was there before and what is gone beyond at this level as a stage and thanks to this mourning. What was there before, was properly speaking transgression (la faute): he carried all the burden, all the weight of his (-^>). He was - remember the use that I made at one time of the passage of St Paul - he was "a sinner beyond all measure".

I take the next step then: the woman has indeed, as you see, no trouble and, let us say, up to a certain point, runs no risk in seeking what is involved in the desire of the man. But I cannot do less on this occasion than to remind you of the celebrated passage of the text attributed to Solomon which I quoted a long time before this seminar, and which I give you here in Latin where it takes on all its savour: "Tria sunt difficilia mihi," says the wise king, "et quartum penitus ignoro" - there are four things about which I can say nothing, because they leave no trace: "viam aquilae in coelo" - the track of the eagle in the heavens, that of the snake on the earth, that of the ship in the sea - "et viam viri in adolescentula" and the track of man, the accent is put even on the young girl. No trace. What is involved here is desire, and not what happens when it is the object as such that is put forward. This leaves to one side therefore the effects, on the adolescentula, of many things, (4) beginning with the exhibitionist and behind that the primal scene. But it is something different that is involved here.

So then how should we tackle things in order to conceive of how there operates in the case of the woman this thing that we suspect, where she also has a way into lack - it is

sufficiently dinned into our ears - with this business of Penisneid? It is here that I believe it necessary to emphasise the difference: for her too of course there is also the constitution of the object o of desire, since as it happens women also speak. One may regret it, but it is a fact. She also for her part also wants the object, and even an object in so far as she does not have it. This is what Freud explains to us, that for her this claiming of the penis will remain up to the end essentially linked to the relationship to the mother, namely to demand. It is in dependence on the demand that there is constituted this object o for the woman. She knows very well - dare I say: something knows in her - that in the Oedipus complex what is involved is not to be stronger, more desirable than the mother - at bottom she notices quickly enough that time is on her side - it is to have the object. The fundamental dissatisfaction that is involved in the structure of desire is, as I might say, pre-castrational. If it happens that she becomes interested in castration, ^{as} such, it is in so far as she enters into the man's problems, it is secondary, it is deutero-phallic as Jones very correctly articulated it, and it is around this that there turns the whole obscurity of the debate that, when all is said and done, has never been disentangled, about this famous phallicism of the woman, a debate in which I would say, all the authors are equally right, for want of knowing where the articulation really is. I am not claiming that you are going to keep it in mind immediately in a sustained, present, lively and locatable fashion, but I intend all the same to take you right through it along a sufficient number of paths for you to end up by knowing where it passes and where something is skipped over when peopxe theorise. For the woman, it is initially what she does not have as such which is going to become, to constitute at the beginning the object of her desire; while at the beginning for the man it is what he is not, it is where he fails. That is why I made you advance along the path of the Don Juan phantasy. The phantasy of Don Juan - and this is why it is a feminine phantasy - is this wish in the woman for an image which plays its function, its phantastical function, that there is at least one man who has it from the beginning, which is obviously, from the point of view of experience, an obvious miscognition of reality, but much better still: that he always has it, that he cannot lose it. What the position of Don Juan in the phantasy implies precisely, is that no woman can take it from him, this is what is essential and it is obviously - this is why I have said that it is a feminine phantasy - what he has in this case in common with the woman whom, of course, one cannot take it from, because she does not have it. What the woman sees in the homage of masculine (5) desire is that this object, let us say, let us be prudent, becomes something belonging to her. This means nothing more than what I have previously put forward: that it should not be lost. The lost member of Osiris, such is the object of the quest and of the protection of the woman. The fundamental myth of the sexual dialectic between man and woman is here sufficiently accentuated by a whole tradition, and moreover what "psychological" (in inverted commas) experience, in the sense that this word has in the writings of Paul Bourget, about the woman does not tell us is that a woman always thinks that a man loses himself, goes astray

with another woman. Don Juan reassures her that there is a man who never loses himself in any circumstance.

Obviously there are other privileged, typical fashions of resolving the difficult problem of the relationship to o for the woman, another phantasy, if you wish. But in truth, this is not the genuine article, she is not the one who invented it. She finds it ready made. Of course to be interested in it, it is necessary that she should have, as I might say, a certain sort of stomach; I envisage, if I may say here in the order of the normal, this type of rugged fucker which St Teresa of Avila gives us the most noble example of, access to which, a more imaginary one, is given by the type of the woman who falls in love with priests, another notch: the erotomaniac. The nuance, the difference between them is, as I might say, at the level at which the desire of man collaborates in a more or less imaginary fashion as being entirely confused with the o. I alluded to St Teresa of Avila, I could also have spoken about Blessed Marguerite Mary Alacoque, she has the advantage of allowing us to recognise the very form of the o in the Sacred Heart. For the woman who loves priests, it is certain that it is in the measure that something that we cannot simply describe crudely as institutionalised castration is enough to establish, it is all the same in this direction - you are going to see that we are going to advance - that the small o as such is put forward in a perfectly isolated way, proposed as the elective object of her desire. For the erotomaniac, there is no need for the work to be prepared: she does it for herself.

And now we have come back to the earlier problem, namely what we can articulate about the relationships of man - it is he, he alone, who can give us its key - of the relationship of these diverse o's which are proposed or impose themselves or which one more or less disposes of, to what is not discerned, is not defined, and is not distinguished as such, namely giving its final status to the object of desire, in this relationship to castration.

I would ask you to return for a moment to my mirror stage. Once upon a time a film was shown which was made somewhere in England; in a school which made a specialised effort to harmonise what infant observation could give us compared to psychoanalytic development, the value of this document being all the greater (6) because this observation, this shooting, was made without the slightest preconceived idea. It involved, because the whole field of what can be observed had been covered, the confrontation of the little male and female baby with the mirror. The initial and terminal dates that I had given were, by the way, fully confirmed in it. I remember that this film was one of the last things to be presented at the Society Psychanalytique de Paris before we separated from it. The separation was very near and it was perhaps viewed at that time a little distractedly; but I had, I assure you, all my wits about me and I still remember this gripping image in which the little girl confronted with the mirror was represented. If there is something which illustrates this reference to the non-specularisable, which illustrates,

which materialises, concretises this reference to the non-specularisable which I put forward last year, it is indeed the gesture of this little girl, this hand which passes rapidly over the gamma of the junction of the tummy and the two thighs like a kind of moment of vertigo before what she sees.

The little boy for his part, the poor clown, looks at his little problematic tap. He vaguely suspects that it is something a little bizarre. For his part, he has to learn - at his own expense as you know - that, as one might say, what is there does not exist, I mean compared to what Daddy has, to what his big brothers etc...., have, you know the whole first dialectic of comparison. He will subsequently learn that, not only does it not exist, but that it wants to know nothing or more exactly that it behaves exactly as it wishes. In a word, it is only step by step in his individual experience, that he has to learn to erase it from the map of his narcissism, precisely so that it can begin to be of some use. I am not saying that it is all that simple, it would be really senseless to attribute that to me. Of course, naturally, as soon as, as I might say, the more it is buried, the more it remounts to the surface and, when all is said and done, that this operation - I am only giving you an indication here, but after all an indication which will link up, I think, sufficiently with what has been indicated to you about the fundamental structure of what is ridiculously called perversion - that this operation here, is the source of homosexual attachment. Homosexual attachment is: I play the game of the loser wins. At every moment in homosexual attachment, it is this castration which is at stake, and this castration which assures the homosexual, that it is really it, the , which is the object of the game. It is in the measure that he loses that he wins.

Now then I come to illustrate something which to my astonishment gave rise to problems the last time in my reminder of the mustard pot. One of my particularly attentive listeners said to me: "That went down well, that mustard pot, at least there were a certain number of us who were not too put off by it. But now you are introducing the question of the contents. You half fill it with what?" So let's go at it. The (-f) is the emptiness of the vase, the same one as defines the homo faber. If woman, we are told, is primarily a weaver, man undoubtedly is the potter and this is even the only angle through which there is realised in the human species a grounding for the jingle which tells us, the thread is for the needle like the girl is for the boy; this kind of reference which claims to be natural, is not as natural as all that.

The woman, of course, presents herself under the appearance of a vase. And obviously this is what deceives the partner, the homo faber in question, the potter. He imagines that this vase may contain the object of his desire. Only look carefully where that leads us, it is inscribed in our experience, it has been spelled out step by step - and this is what removes from what I am telling you any kind of appearance of deduction, of reconstruction - the thing was perceived without in any way starting from the proper place in the premisses, but it was

perceived well before understanding what it meant. The phantastical presence of the phallus, I mean of the phallus of another man, at the bottom of this vase is a daily object of our analytic experience. It is quite clear that I do not need to return once again to Solomon to tell you that this presence is an entirely phantastical presence. Of course, there are things which are found in this vase, things that are very interesting for desire: the egg for example; but after all it comes from the inside and proves to us that if there is a vase, the schema must be complicated a little bit more. Of course, the egg can take advantage of the encounters that the fundamental misunderstanding prepares, I mean that it is not useless for it to encounter here the sperm, but after all parthenogenesis is not excluded in the future and meanwhile insemination can take on quite different forms. Besides, it is, as I might say, in the back room of the shop that there is found in this case the really interesting vase, the uterus. It is objectively interesting, it is also psychically so to the highest degree, I mean that once there is maternity, it is largely sufficient to invest the whole interest of the woman, and when pregnancy arrives all these stories about the desire of the man become, as everyone knows, slightly superfluous.

So then since we have to do it let us come to the pot we mentioned the other day, to the honorable little pot of the first ceramics and let us identify it with (-0). Allow me for the



purposes of demonstration to put here for a moment in a neighbouring little pot what for man can be constituted as o, the object of desire. It is an apologue; this apologue is designed to emphasise that o

only has meaning for man when it has been poured back into the emptiness of primordial castration.

(8) Therefore this cannot be produced in this form, namely constituting the first knot of male desire with castration, unless on3 starts from secondary narcissism, namely at the moment that o is detached, falls from i(o), the narcissistic image. There is there what I would call, indicating it today in order to return to it, and besides - I think that you remember it - not introducing here anything that I have not already emphasised, a phenomenon which is the constitutive phenomenon of what one can call the "edge". As I told you last year in connection with my topological analysis, there is nothing more structuring of the shape of the vase than the shape of its edge, than the cut by which it is isolated as vase.

At a time - now distant - when there was outlined the possibility of a veritable logic remade in accordance with the psychoanalytic field - it is still to be done, even though I have given you more than one beginning for it - a major and a minor logic, I am saying logic not dialectic, at the time when someone like Imre Hermann had begun to devote himself to it in what was certainly a very confusing fashion, for want of any dialectical articulation - but after all this has been outlined - the phenomenon that he qualifies as Randbevorzugung, of choice, of preference by the

phenomenal analytic field for "edge" phenomena had already been - I will come back to it with you - articulated by this author.

This edge of the little pot, of the castration-pot is an edge, for its part, that is completely round, as I might say, completely straight forward. It has none of these complicating refinements to which I introduced you with the Mobius strip and which it is easy moreover, as I showed you - you remember it, I think - once on the blackboard, to realise with a quite material vase: it is enough to join up two opposite points of its edge while in the process turning back the surfaces in such a way that they join up like in the Mobius ribbon and we find ourselves before a vase on which, in a surprising fashion, one can pass with the greatest of ease from the inside face to the outside face without ever having to cross the edge. That happens at the level of other little pots and it is here that anxiety begins.

Of course a metaphor like this is not enough to reproduce what must be explained to you. But that this original little pot has the closest relationship with what is involved as regards sexual potency, with the intermittent springing forth of its force, is what everything that I could call a series of images, that are easy to put before your eyes, of an eroto-propaedeutics, indeed even properly speaking of an erotics, gives a quite easy access to. A crowd of images of this type, Chinese, Japanese and others and, I imagine ones that are not difficult to find either in our culture, will bear witness to it for you. This is not what is anxiety-provoking. That the decanting (transvasement) here allows us to grasp how the o takes on its value because it comes into the pot of ($\sim\langle p \rangle$), takes on its value by being here -o, the (9) vase half-empty at the same time as it is half-full - this is what I told you the last time - it is obvious that to really complete my image it is necessary that I should underline that it is not the phenomenon of decanting that is essential, it is the phenomenon to which I have just alluded of the transfiguration of the vase, namely that this vase here becomes anxiety-provoking, why? Because what comes to half-fill the hollow constituted from the original castration, is the small o in so far as it comes from elsewhere, that it is only supported, constituted through the mediation of the desire of the Other. And it is there that we rediscover anxiety and the ambiguous shape of this edge which, because of the way it is made at the level of the other vase, does not allow us to distinguish either the inside or the outside.

Anxiety therefore comes to constitute itself, to take its place in a relationship beyond this emptiness of what I might call a first phase of castration. And this is why the subject has only one desire as regards this primary castration, which is to return to it.

I will speak to you at length, after the interruption that we are going to have, about masochism and there is of course no question of my tackling it today. If you want to prepare yourselves for it, to understand me about it, I am giving now - it is a lapse on my part if I did not do it earlier when I began to speak to you -

information about an article, which is extremely precious because it is the fruit of very substantial experience. It is an article by a man who is indeed one of those in connection with whom I feel the greatest sorrow that circumstances deprived me of his collaboration, it is the article by Grunberger: "Esquisse d'une théorie psycho-dynamique du masochisme" in the April-June 1954, number 2, of volume XVIII of the Revue Française de Psychanalyse. I do not even know if this article has been given the fate it merits elsewhere; but whether this forgetfulness is due to the fact that it appeared in the shadow of the display surrounding the foundation of the Institut de Psychanalyse, is something I will not try to settle. But you will see there - this is not at all the final word - you will see noted - I am only invoking it here to show you right away the value of the material that one can find in it - you will see noted, at the high point of the day-by-day observation of the analytic session, how having recourse to the very image of castration, to the fact that I would like them to be cut off, can come as a peaceful, salutary outcome to the anxiety of the masochist. What we have here - I underline it - is not a phenomenon which is the final word of this complex structure; but moreover on this point I have sufficiently initiated my formula for you to know that I am on this occasion, I mean as regards the link between anxiety and masochism, aiming at a point which is quite different to this point within what I could call the momentary dismay of the subject. It is only an indication that I find there. But this phase of castration in so far as the subject returns to it, in so far as it becomes a point he aims at, brings us back to what I (10) already emphasised at the end of one of my last seminars about circumcision.

I do not know, Stein, where you have got to in the commentary that you are pursuing of Totem and Taboo and whether this has yet led you to tackle Moses and Monotheism. I think that you cannot but come to it and be struck in it then by the total avoidance of what is nevertheless a structuring problem if one is to find in the Mosaic institution something which reflects the inaugural cultural complex, namely what was on this point the function of the institution of circumcision. You should notice that in any case there is something in this removal of the prepuce which you cannot fail to connect with this funny little twisted object that I one day passed around among you in a material way, so that you could see how it is structured once there has been realised in the shape of a little piece of cardboard, this result of the central cut on what I illustrated, incarnated for you here in the shape of the cross-cap, in order to show you how this isolation of something, which is defined precisely as a shape incarnating as such the non-specularisable, can have to do with the constitution of the autonomy of the o, of the object of desire.

That something like an order can be brought into this hole, this constitutive failure of primordial castration, is what I believe circumcision incarnates in the proper sense of the word. The circumcised person, and circumcision, have by all their coordinates, all the ritual, indeed mythical configuration, the primordial initiatory entrances which are those where it

operates, the most obvious relationship with the normativizing of the object of desire. The circumcised person is consecrated, though less consecrated to a law than to a certain relationship to the Other, to the big O, and that is the reason why the small o is involved. It remains that we are, at the point that I intend to bring the fire of sunlight, namely at the level that we can find in the configuration of history something which is supported by a big O, who is there more or less the God of the Judaeo-Christian tradition, it remains to be seen what circumcision signifies. It is extremely astonishing that in a milieu as Judaeic as the psychoanalytic milieu, that texts gone over a hundred thousand times, from the Fathers of the Church to the Fathers of the Reformation, that is to say up to the eighteenth century - and again, to tell you the fruitful periods of the Reformation - that these texts have not been reinterrogated. No doubt what we are told in Chapter XVII of the Book of Genesis, concerning the fundamental character of the law of circumcision in so far as it forms part of the pact given by Yahweh in the bush, the reference of this law to the time of Abraham - this is what Chapter XVII consists of, it is to date the institution of circumcision from Abraham, no doubt this passage is, it seems, an addition according to critical exegesis, a Priestly addition, namely very noticeably later than the Yahwistic and the Elohist tradition, namely than the two primitive texts from which the books of the law are composed - we have nevertheless in Chapter XXXIV the famous episode which does not lack humour which concerns - as you know - the rape of Dinah, the sister of Simeon and Levi, the daughter of Jacob. To get her - because it is a matter for the man from Shechem who kidnapped her of getting her from her brothers - Simeon and Levi demand that they should be circumcised: "We cannot give our sister to an uncircumcised man, we would be dishonoured". We have obviously here the superimposition of two texts, and we do not know whether it is a single man or all the Shechemites who are done at the same time, in this proposition of an alliance which, of course, could not be made in the name of just two families, but of two races, all the Shechemites have themselves circumcised; the result is that they are out of action for three days which the others take advantage of in order to come and butcher them. It is one of those charming episodes which Monsieur Voltaire could not understand and which made him say so many bad things about this book which is so admirable as regards the revelation of what is called the signifier as such.

This is all the same done to make us think that it is not simply from Moses that the law of circumcision dates. Here I am only highlighting the problems raised in this connection.

Undoubtedly all the same, because Moses is involved and because Moses in our domain is recognised as being an Egyptian, it would not be altogether useless for us to pose the question of what is involved as regards the relationship of Judaeic circumcision with the circumcision of the Egyptians.

This will make me apologise for prolonging again, let us say by five or seven minutes, what I have to say to you today so that

what I have written on the board will not be lost for you.

We have the assurance, through a certain number of authors in antiquity and specifically this old Herodotus who no doubt talks nonsense in some places, but who is often very precious, and in any case who leaves no kind of doubt that at his time, namely at a very low time for the Jews, the Egyptians on the whole practiced circumcision; he even makes such a prevalent state of it that he says that it is to the Egyptians that all the Semites of Syria and of Palestine owe this usage. A lot has been said on this point; after all we are not at all forced to believe him. This he bizarrely puts forward in connection with the Colohidians which he pretends are an Egyptian colony. But let us leave that to one side.

He makes of it, Greek as he is - and after all at his time, he could scarcely have made anything else of it - a measure of cleanliness. He underlines for us that the Egyptians prefer being clean, *katarrinao*, to what is described as a beautiful appearance, hence Herodotus, Greek as he is, does not conceal from us that it seems to him that to circumcise oneself is always (12) to disfigure oneself a little.

We have luckily more direct testimonies and supports about Egyptian circumcision. We have two testimonies that I will describe as iconographic - you will tell me that this is not a lot - : one is from the old empire, it is at Saqqarah in the tomb of Doctor Ank Maror (?). It is said that he is a doctor because the walls of the tomb are covered with figures of operations. One of these walls shows us two representations of circumcision, the other is to the right of this one, I have represented for you the one on the left; I do not know how I succeeded in making readable or whether I succeeded in making readable my drawing which has as an ambition to limit itself and to emphasise perhaps a little in this case the lines as they are presented; here is the boy who is being circumcised and here is the organ. A boy, who is behind him, holds his hands because it is necessary; a personage who is a priest, about whose description I will say no more today, is here; in one hand - it is the left hand - he holds the organ of the other, this oblong object is a stone knife. This stone knife, we rediscover in another text which has remained up to now completely enigmatic, a biblical text which says that after the episode of the Burning Bush, when Moses is advised that nobody in Egypt remembers, more exactly that all of those who remembered the murder that he carried out of an Egyptian, have disappeared, that he can return; he returns and, on the way, the biblical text tells us - on the road where he stops, it used to be translated in a hostelry; but let us leave that - Yahwe attacks him in order to kill him. This is all that is said. Zipporah, his wife, then circumcises her son who is a small child and touching Moses, who is not circumcised, with the prepuce protects him mysteriously by this operation, by this contact, from the attacks of Yahweh who then goes away and leaves him, brings his attack to a halt. It is said that Zipporah circumcised her son with a stone knife.

Some forty years later - because there is also the whole episode of the trials imposed on the Egyptians and the ten plagues - at the time of entering into the land of Canaan, Joshua receives the order: "Take a stone knife and circumcise all those who are here, who are going to enter into the land of Canaan". It is those and only those who are born during the years in the desert; during the years in the desert, they were not circumcised. Yahwe adds: "Now I will have rolled away from on top of you" - which is translated by lifted, suspended - "the contempt of the Egyptians". (Joshua V:VI)

I remind of you of these texts, not because I have the intention of using them all, but to stimulate in you at least the desire, the need, to consult them. For the moment, I will stop at the stone knife.

The stone knife indicates in any case a very ancient origin for this ceremony, which is confirmed by the discovery by Elliot Smith, near Luxor, if I remember rightly, probably at Magadeh (?) which has so many other reasons for attracting our interest as (13) regards this very question of circumcision, of corpses from the pre-historic period - namely not corpses which are mummified according to norms which allows them to be dated in Egyptian history - which carry the traces of circumcision. The stone knife, all by itself, should designate for us a date, an origin for this ceremony which is at least at the epoch that is defined as the Neolithic Age.

Besides so that there should be no doubt, three Egyptian letters, these three, which are respectively an S, a B, and a T, S(e)B(e)T, expressly indicate to us that it is circumcision that is involved. The sign marked here is an hapax, it is found nowhere but there; it seems that it is an effaced, a worn down lorme of the determinant of the phallus. We find it in other inscriptions where you see it inscribed much more clearly.

Another way of designating circumcision is the one which is in this line and which is read "FaHeT", F, the aspirated H which is here this sign which is here the placenta and here the T which is the same as what you see here. Here a determinant which is the determinant of linge (?), it is not pronounced. I would ask you to take note of it today because I will come back to it. Here another F designates "he" and here the PaN which means the prepuce, PaN means "to be separated from one's prepuce". This has also all its importance, for circumcision is not to be taken uniquely as what I might call a totalitarian operation, a sign. The "to be separated from something" is from that moment here, in an Egyptian inscription, articulated properly speaking. As I told you, I am only going so far in order not to have wasted my time writing that here today.

This function of the prepuce, which is in a way the goal, the value which in these inscriptions is given, as one might say to the weight of the least word, the maintenance, as I might say, of the prepuce as the object of the operation, just as much as the one who undergoes it, is something whose emphasis I would ask you

to retain here because we rediscover it in a text of Jeremiah which is just as enigmatic, just as uninterpreted up to the present, as the one to which I have just alluded before you, specifically the one about the circumcision by Zipporah of her son, I will then have an opportunity to come back to it.

I think I have already sufficiently initiated the function of circumcision, I mean not simply in its coordinates of celebration, of initiation, of introduction to a special consecration, but in its very structure as a reference, which is essentially interesting for us, to castration as regards its relationships with the structuring of the object of desire, I think have sufficiently initiated things in this direction to be able effectively to take them further with you on the day that I have given you for our next appointment.

Seminar 17: Wednesday 8 May 1963

I left you on a remark which put in question the function of circumcision in the economy of desire, in the economy of the object, in the sense that analysis grounds it as an object of desire. This lecture ended on a text, on a passage from Jeremiah - verses 24 and 25 of Chapter 9 - which in truth has posed some difficulties for translators throughout the ages, because the Hebrew text - I have too much to say to you today to delay on the letter of the text - for the Hebrew text, I am saying, should be translated: "I will punish every circumcised man in his prepuce", a paradoxical term that the translators have tried to get around, even one of the best of them, Paul Dorn, by the formula: "I will punish every circumcised man as if he were uncircumcised".

I am only recalling this point here to indicate to you that it is indeed some permanent relationship to a lost object as such that is involved and that it is only in the dialectic of this object o as cut and as now sustaining, presentifying a relationship essential to this relation itself, that effectively we can conceive of what is involved at this point in the Bible, which is not unique, but a point which illuminates by its extreme paradox what is involved every time the term of circumcised and uncircumcised is effectively employed in the Bible. It is not at all in effect, far from it, limited to this little bit of flesh which constitutes the object of the ritual. "Uncircumcised lips", "uncircumcised heart", these are terms which right through this text, appear numerous, almost current, almost common, underlining that what is involved is always an essential separation from a certain part of the body, a certain appendix, from something which in a function becomes symbolic of a relationship to the body itself henceforth alienated, and fundamental for the subject.

I will take things up today from a broader, higher, more distant point of view. You know, some of you know, that I have just returned from a journey which brought me some new experiences and which also brought me, in its essence in any case, the approach, the view, the encounter with some of these works without which the most attentive study of texts, of the letter, of the doctrine, specifically that of Buddhism in this case, must remain in some way incomplete and lifeless.

I think that to give you some report of what this approach was, (2) of the way in which, for me and for you also I think, it can

be inserted into what is this year our fundamental question, the point where the dialectic of anxiety takes place, namely the question of desire, which in our approach can from now on be, can represent for us from now on, a contribution.

Desire in effect constitutes the essential basis, the goal, the aim, the practice also of everything here that is denominated and announced about the Freudian message. Something absolutely essential, new, passes through this message. This is the path along which - who among you, there is surely someone among you, some people, I hope, who can pick it up - along which this message passes. We should justify at the point that we are at, namely at every point of a renewal of our remotivated elan, what is involved in this locus this year, this subtle locus, this locus that we are trying to circumscribe, to define, to coordinate, that this locus never located up to now in what we could call its ultra-subjective influence, this central locus of what one could call the pure function of desire. This locus into which we are advancing a little further this year with our discourse about anxiety, is the locus where I am demonstrating for you how ϕ is formed.

ϕ , the object of objects, the object for which our vocabulary has put forward the term objectality in so far as it is opposed to that of objectivity.

To sum up this opposition in some formulae - I apologise that they have to be so rapid - we will say that objectivity is the final term of Western scientific analytic thinking, that objectivity is the correlate of a pure reason which, when all is said and done, is the final term which for us is expressed, is resumed by, is articulated in, a logical formalism.

Objectality, if you have been following my teaching of about the past five or six years, objectality is something else and to highlight it at its most crucial point, I would say, I would formulate, that in contra-distinction to the preceding formula which I have just given, objectality is the correlate of a pathos about the cut, and precisely of the one through which this same formalism, logical formalism, in the Kantian sense of this term, this same formalism rejoins its miscognised effect in the Critique of pure reason, an effect which accounts for this formalism even in Kant, in Kant especially I would say, remains hewn out of causality, remains suspended on the justification that no a priori has up to now managed to reduce, of this function which is nevertheless essential to the whole mechanism of the lived experience of our mental life, the function of the cause. Everywhere the cause and its function prove to be (3) irrefutable even if it is irreducible, almost ungraspable for critical thinking. What is this function? How can we justify its survival against every attempt to reduce it, an attempt which constitutes almost the sustained movement of the whole critical progress of Western philosophy, a movement of course which was never completed. If this, this cause, proves to be so irreducible, it is in so far as it is superimposed, as it is identical in its function to what I am teaching you this year to

circumscribe, to handle, namely precisely this part of ourselves, this part of our flesh which necessarily remains, as I might say, caught up in the formal machine. That without which this logical formalism would be absolutely nothing for us, namely that it does not just provide us with, that it does not just give us the framework, not alone of our thinking, but of our own transcendental aesthetic, that it lays hold of us somewhere and that, this part that we give, not alone the material, not alone the incarnation as thinking being, but the fleshy piece as such torn from ourselves, it is this piece in so far as it is what circulates in logical formalism as it has already been elaborated by our work on the use of the signifier, it is this part of ourselves caught up in the machine, that can never be recuperated, this object as lost at different levels of corporal experience where the cut is produced, is the support, the authentic substratum of every function as such of the cause. This part of ourselves, this corporal part is therefore essentially and by function partial. Of course it is well to recall that it is body, that we are only objectal (objectaux) - which means object of desire - as bodies, an essential point, an essential point to recall because it is one of the creative fields of negation to appeal to something else, to some substitute; this is what nevertheless always remains at the final term, the desire for the body, the desire for the body of the other, and nothing but the desire for his body. One can say, one certainly says, "It is your heart that I want, nothing else", and by this one intends to say something spiritual: the essence of your being or again your love; but here, as always, language betrays the truth. This heart here is only a metaphor if we do not forget that there is nothing in the metaphor which justifies the common usage of books of grammar in opposing the proper sense to the figurative sense. This heart can mean many things, different things are metaphorised according to cultures and tongues. For the Semites, for example, the heart is the organ of (4) intelligence itself. And it is not these nuances, these differences that are at stake, that is not what I want to draw your attention to. This heart, in this formula: "It is your heart that I want", is here, like every other organ- metaphor, to be taken literally. It is as a part of the body that it functions, it is, as I might say, as guts.

After all, why have some metaphors subsisted for so long - and we know the places, I have alluded to them, where they still live, specifically in the cult of the Sacred Heart - why, since the time of the living literature of Hebrew and Akkadian regarding which this little book by Edouard Dorn reminds us of the degree to which the metaphorical use of names of the parts of the body is fundamental to any understanding of these ancient texts, why this remarkable lack in Toutes les parties du corps, which I recommend to you, which can be found, which has just been re-issued by Gallimard: if all the parts of the body are paraded in their properly metaphorical functions, the sexual organ and especially the male sexual organ, even though all the texts which I evoked earlier on circumcision were there to be evoked, the male sexual organ and the prepuce are remarkably, very strangely omitted, they are not even in the table of contents.

How can the still living, metaphorical usage of this part of the body to express that which in desire, beyond appearances, is properly what is required in this haunting memory of what I would call causal guts (la tripe causale), how can it be explained, if not by the fact that the cause is already lodged in the gut, as I might say, figured in the lack; and moreover in all the mythical discussion of the functions of causality, it is always tangible that references go from the most classical positions to those which are the most modernised, for example that of Maine de Biran: when it is by the sense of effort that he tries to make us sense the subtle balance around which there is played out the position of what is determined, of what is free when all is said and done, it is always to this corporal experience that we refer. What I will still put forward to give a sense of what is involved in the order of the cause is what, when all is said and done? My arm, but my arm in so far as I isolate it, that considering it as such, as an intermediary between my will and my act, if I dwell on its function, it is in so far as it is isolated for an instant, and that I must at all costs and from whatever angle I recuperate it, that I must right away modify the fact that, if it (5) is an instrument, it is nevertheless not free, that I must remain on my guard, as I might say against the fact, not immediately of its amputation, but of its non-control, against the fact that someone else may take it over, that I may become the right arm or the left arm of someone else, or simply against the fact that like a vulgar umbrella, - just like the corsets which it appears were found there in abundance a few years ago - I may forget it in the Metro.

We analysts for our part know what that means - the experience of the hysteric is something sufficiently significant for us - which means that this comparison in which it can be glimpsed that the arm can be forgotten, neither more nor less like a mechanical arm, is not a forced metaphor. This is the reason why I reassure myself of its belonging with the function of determinism: it is very important to me that even when I forget its functioning, I know that it functions in an automatic fashion, that an inferior stage assures me that whether tonic or voluntary, all sorts of reflexes, all sorts of conditionings assure me that it will not escape, even when one takes into account an instant of inattention on my part.

The cause therefore, the cause always arises in correlation with the fact that something is omitted in the consideration of knowledge, something which is precisely the desire which animates the function of knowledge. Every time the cause is invoked, in its most traditional register, is in a way the shade, the pendant, of what is the blind spot in the function of this knowledge itself. This of course is something that we did not have to wait for Freud to invoke. Already well before Freud - do I need to evoke Nietzsche and others before him - others had put in question the desire involved in the function of knowledge, others had questioned what Plato had in mind that made him believe in the central, original, creative function of the "Sovereign Good", what Aristotle had in mind which made him believe in this singular prime mover which comes to put itself in

the place of the Anaxagorean nous, which nevertheless can only be for him a deaf and blind mover to what it sustains, namely the whole cosmos. The desire for knowledge with its consequences had been put in question, and always in order to put in question what knowledge believes itself obliged to forge precisely as final cause.

This sort of critique culminates at what? At what I might call a sort of sentimental putting in question of what appears to be most stripped of sentiment, namely elaborated, purified, in its (6) final consequences. It contributes to the creation of a myth which will be the myth of the psychological origin of knowledge: these are aspirations, instincts, needs: by all means add on religious, you will only be taking another step: we will be responsible for all the deviations of reason, the Kantian Schwarmerein with all its implicit openings onto fanaticism.

Is this a critique that we can be satisfied with? Can we not take further what is involved? Articulate it in a more daring fashion beyond the psychological, which is inscribed in its structure. It is hardly necessary to say that this is exactly what we are doing. What is involved is not simply a feeling which requires its satisfaction. What is involved is a structural necessity: the relationship of the subject to the signifier necessitates the structuring of desire in the phantasy. The functioning of the phantasy implies a temporally definable syncope of the function of o which necessarily at some phase of phantastical functioning is effaced and disappears. This aphanisis of the o, this disappearance of the object in so far as it structures a certain level of the phantasy, this is what we have the reflection of in the function of the cause; and every time we find ourselves confronted with the same unthinkable handling of critical thinking which nevertheless is irreducible, even to critical thinking; every time we find ourselves confronted with this final functioning of the cause, we ought to search for its foundation, its root in this hidden object, in this object qua syncope. A hidden object is at the source of this faith in the prime mover of Aristotle which I presented to you earlier as deaf and blind to what causes it. The certainty, this very contestable certainty, always linked to derision, this certainty which is attached to what I would call the essentialist proof, which is not only that of Saint Anselm - because you will also rediscover it in Descartes - the one which tends to found itself on the objective perfection of the idea in order to found in it its existence, if this precarious and derisory certainty maintains itself despite all criticism, if we are always forced from some angle to come back to it, it is only because it is the shadow of something else, of another certainty; and this certainty here, I already named it, you can recognise it, because I already called it by its name: it is that of the anxiety linked to the approach to the object, this anxiety which I told you must be defined as that which does not deceive, the only certainty, which is founded, unambiguous, that of anxiety: anxiety precisely in so far as every object escapes it. And the certainty linked to the recourse to the primary cause and the shadow of this fundamental certainty, its shadowlike character is

what gives it this essentially precarious aspect, this aspect which is only really surmounted by this affirmative articulation which always characterises what I have called the essentialist argument, this something which forever is for it what is in it, what does not convince. This certainty, therefore, by being sought in this way, in its true foundation proves what it is: it is a displacement, a secondary certainty, and the displacement involved is the certainty of anxiety.

What does this imply? Undoubtedly a more radical putting in question than has ever been articulated in our Western philosophy, the putting in question as such of the function of knowledge, not at all that this putting in question - I hope to make you glimpse this - has not been done elsewhere. With us, it can only begin to be done in the most radical fashion if we grasp what is meant by this formula that there is already knowledge in the phantasy.

And what is the nature of this knowledge which is already in the phantasy? It is nothing other than the following which I repeat right away: man, if he speaks, the subject once he speaks is already implicated in his body by this word. The root of knowledge is this engagement of his body. But it is not this sort of engagement that undoubtedly, in a fruitful fashion, in a subjective fashion, contemporary phenomenology has tried to engage with by reminding us that in every perception, the totality of the corporal function - the structure of the organism of Goldstein, the structure of behaviour of Maurice Merleau-Ponty - that the totality of corporal presence is engaged.

Notice that what is happening along this path, is something which undoubtedly has always appeared to us to be very desirable: the solution of the body-spirit dualism. But it is not because a phenomenology, which has moreover reaped a rich harvest of facts, makes for us of this body, taken at the functional level, as I might put it, a sort of double, of opposite to all the functions of the spirit, that we ought to find ourselves satisfied. Because indeed there is here all the same some evasion. And moreover everyone knows that the reactions which are undoubtedly of a philosophical nature or even of a fideist nature that contemporary phenomenology has been able to produce among the servants of what could be called the materialist cause, that these reactions that it has given rise to are undoubtedly not (8) unjustified. The body as it is thus articulated, indeed banished from experience in the sort of exploration inaugurated by contemporary phenomenology, the body becomes something altogether irreducible to material mechanisms. After long centuries succeeded in making a spiritualised body for us in art, the body of contemporary phenomenology is a corporalised soul.

What interests us in the question of what the dialectic involved must be brought back to, in so far as it is the dialectic of the cause, is not that the body participates in it, as one might say, in its totality. It is not the fact of pointing out that eyes are not all that are necessary in order to see, but that undoubtedly our reactions are different according as our skin, as

was pointed out by Goldstein, who was not lacking in perfectly valid experiments, according as our skin is bathed or not in a certain atmosphere of colour. That is not the order of events involved here in this reminder of the function of the body. The engagement of the man who speaks in the chain of the signifier with all its consequences, with this henceforth fundamental springing forth, this elective point that I earlier called that of an ultra-subjective radiation, this foundation of desire in a word, it is in so far as, it is not that the body in its functioning would allow us to reduce everything, to explain everything in a reduction to the dualism of the Umwelt and the Innenwelt, it is because there is always in the body, and by the very fact of this engagement in the signifying dialectic, something separated, something statufied, something inert from then on: that there is a pound of flesh.

One cannot but be astonished once again at this turn, at the unbelievable genius which guided the person we call Shakespeare to fix in the figure of the Merchant of Venice this theme of the pound of flesh which reminds us of this law of debt and of gift, this total social fact, as it is expressed, has been expressed since Marcel Mauss - but it was certainly not a dimension that was allowed to escape at the dawn of the seventeenth century: this law of debt does not take its weight from any element that we could consider purely and simply as a third, in the sense of an outside third, the exchange of women or of goods as Lévi-Strauss recalls in his Elementary Structures. What is at stake in a pact, can only be and only is this pound of flesh, as it is put in the text of The Merchant: "to be cut off by him nearest the heart".

(9) Undoubtedly it is not for nothing that after having animated one of his most fiery plays with this thematic, Shakespeare pushed by a sort of divination which is nothing but the reflection of something always touched on and never attacked at its deepest level, attributes it, situates it with respect to this merchant who is Shylock, who is a Jew. The fact is moreover that I believe that no history, no written history, no sacred book, no Bible, to say the word, is better designed than the Hebrew Bible to make us sense this sacred zone in which the moment of truth is evoked, that we can express in religious terms by this implacable aspect of the relationship to God, this divine wickedness which ensures that it is always with our flesh that we must discharge our debt.

This domain which I told you is scarcely touched on must be called by its name. This designation precisely in so far as *ix* gives for us the value of different biblical texts, is essentially correlative to what so many analysts felt obliged, and sometimes not without success, to question themselves about, namely the sources of what is called anti-Semitic feeling. It is precisely in the sense that this sacred and I would almost say forbidden zone is there more lively, better articulated than any other place, and that it is not only articulated, but after all alive and still carried in the life of this people in so far as it presents itself, in so far as it subsists of itself in the

function that, in connection with o, I already articulated with a name which I described as that of the remainder - it is something which survives the ordeal of the division of the field of the Other by the presence of the subject - of something which is that which in a particular biblical passage is formally metaphorised in the image of the stump, of the cut trunk from which a new trunk re-emerges in this living function in the name of Isaiah's second son Shear-Jashub, a remainder, a remnant, will come back in this Shorit that we also find in a particular passage of Isaiah, the function of the remainder, the irreducible function, the one which survives every ordeal of the encounter with the pure signifier, this is the point where already the end of my last lecture with the remarks of Jeremiah, of the passage of Jeremiah about circumcision, this is the point that I have led you to already.

This is also the one of which I indicated the Christian solution and I must say attenuation, namely the whole mirage which in the Christian solution can be said to be attached at its root to the masochistic outcome, can be attributed to this irreducible relationship to the object of the cut.

(10) In so far as the Christian has learnt through the dialectic of redemption to identify himself ideally to the one who at a particular time identified himself to this very object, to this refuse left by divine vengeance, it is in so far as this solution has been lived, orchestrated, ornamented, poeticised, that I was able, no later than 48 hours ago, to have once again such a comic encounter with the Westerner who returns from the East and who finds that over there they lack heart. They are wily people, hypocrites, dealers, even cheats. Good God, they get involved in all sorts of little schemes. The Westerner who was talking to me, was a very average illustrator, even though in his own eyes he considered himself to be a rather superior sort of star. He thought that over there, in Japan, if he had been well received, my goodness, it was because in the families it was advantageous for them to show that they had relations with someone who had almost won the Prix Goncourt. These are things, he told me, which of course in my - here I censor the name of his province, let us say a province with has no chance of being mentioned - let us say in my native Camargue would never happen. Everyone knows that here we all wear our hearts on our sleeves, we are much more honest, you never have these underhand manoeuvres.

Such is the illusion of the Christian who always believes he has more heart than the others, and God knows why this is? The matter no doubt appears more clearly - this is what I believe I have helped you to see as being essential, it is the basis of masochism - this attempt to provoke the anxiety of the Other, become here the anxiety of God, is effectively second nature for the Christian, namely that this hypocrisy - and everyone knows that in other perverse positions, we are always capable in experience of sensing the playfulness and the ambiguity that are always there - namely that this hypocrisy is more or less the same as what he experiences for his part more as oriental hypocrisy.

He is right to feel that it is not the same, because the Orient is not Christianised. And this is what we are going to try to advance into.

I am not going to do a Kaiserlin here, I am not going to explain to you what oriental psychology is, first of all because there is no oriental psychology. Nowadays, thank God, one goes directly to Japan by the North Pole. This has one advantage: it is to make us sense that it could very easily be considered as a peninsula, as an island off Europe. I assure you that this is in (11) effect what it is. And I predict that one day you will see appearing some Japanese Robert Musil. He will show us where we have got to, and the degree to which this relationship of the Christian to the heart is still alive or whether it is fossilised.

But this is not where I want to lead you today. I want to take an angle, use an experience, stylise an encounter I had and which I indicated to you earlier, to approach something from the field of what is still alive in terms of Buddhist practices and specifically those of Zen. You may well suspect that it is not during such a short raid that I could have brought you back anything. I will tell you perhaps, at the end of what we are now going to go through, a sentence simply gathered from the priest of one of these convents, at Kamakura precisely, with whom a meeting was arranged for me, and who, I assure you, without any urging on my part, brought me a sentence which does not appear to me out of place in what we are trying to define here about the relationship of the subject to the signifier. But this is rather a field to be reserved for the future. The encounters I spoke about earlier were more modest, more accessible encounters, more possible to insert into this sort of lightning journey which are the ones the type of life we lead reduces us to. It is specifically the encounter with works of art.

It may seem astonishing to you that I speak about works of art while what is in question are statues, and statues which have a religious function, which were not constructed in principle with the goal of representing works of art. They undoubtedly are so however in their intention, in their origin. They have always been accepted and felt to be such, independently of this function.

It is therefore absolutely not out of place for us to take this way in, in order to receive from them something which leads us, I would not say, to their message, but to what precisely they can represent, which is the thing which interests us: a certain relationship of the human subject to desire.

I made in haste, with the aim of preserving an integrity which I think is important - I recall it to you as I am passing them out to you - a little montage of three photos of a single statue, of a statue which is among the most beautiful which can I believe be seen in this zone which has no lack of them, what is involved is a statue whose qualifications, denominations I am going to give

you and whose function I am going to make you glimpse, and which is found at the women's monastery, at the nunnery of Todai-Ji at Nara. This will allow me to inform you that Nara was the locus of the exercise of imperial authority for several centuries, which are placed modestly before the 10th century. There are statues there which date from the 10th century. It is one of these statues, one of the most beautiful, the one which is found in the women's monastery of Todai-Ji. I will tell you in a moment what function is involved. So handle them carefully. Because I would like to get the three photographs back later. There are two of them which are copies of one another, they are the same with one enlarged with respect to the other.

We are going into Buddhism. You already know enough, I think, to know that the aims, the principles of the dogmatic source as well as the ascetical practice which can be referred to it, can be resumed, moreover are resumed in this formula which interests us in the keenest possible way in terms of what we have to articulate here, that desire is illusion. What does that mean? The illusion here cannot but be referred to the register of truth. The truth involved cannot be a final truth. The enunciating of "is illusion" in this case is to be taken in the direction which remains to be specified of what the function of the creature (l'etre) may or may not be. To say that desire is illusion is to say that it has no support, that it has no outcome in nor aim towards anything.

You have heard speak, I think, if only in Freud, about the reference to Nirvana. I think that you may have here and there heard speak of it in such a fashion that you could not identify it to a pure reduction to nothingness. The very usage of negation which is current in Zen for example, and the recourse to the sign "mou" which is that of negation here, should not deceive you, the sign "mou" involved being moreover a very particular negation which is a "not to have". This just by itself should be enough to put us on our guard. What is involved, at least in the median stage of the relationship to Nirvana, is well and truly articulated in an absolutely widespread fashion in every formulation of Buddhist truth: it is always articulated in the sense of a non-dualism.

If there is an object of your desire, it is nothing other than yourself. I underline that am not giving you the original feature of Buddhism here; "Tat tuam asi", the "it is yourself" that you recognise in the other is already inscribed in the Vedanta.

Let us say that I am recalling it here, not being able in any way to give you the history, or a criticism, of Buddhism, that I am only recalling it here in order to approach by the shortest paths that to which by this experience, which you are going to see was (13) very particular, that if I localise it there it is because this experience constituted around this statue, an experience I had myself, is characteristic and is usable by us.

The Buddhist experience, in so far as by stages and by advances,

it tends to make for the one who lives it, who becomes engaged in its paths, and also moreover those who engage in it in a properly-ascetic fashion - ascetics are a rarity - presupposes a striking reference to the function of the mirror in our relationship to the object. Effectively this metaphor is habitual. A long time ago I made an allusion in one of my texts, because of what I already knew about it, an allusion to this surfaceless mirror in which nothing is reflected. Such was the term, the stage if you wish, the phase to which I intended to refer for the precise goal that I was aiming at at that time: it was in an article on psychic causality.

You should notice here that this mirror-like relationship to the object is absolutely common to every gnosis. The absolutely common character of this reference is what makes every reference to the notion of projection so easy for us to accede to and also so easy to make an error about. We know how easy it is for outside things to take on the complexion of our soul, and even its form, and even for them to come towards us in the shape of a double.

But if we introduce the object *o* as essential in this relationship to desire, the business of dualism and of non-dualism takes on a completely different relief. If that which is most myself in the outside is there, not so much because I projected it there, but because it was cut off from me, the fact of my rejoining it or not and the paths that I will take to ensure this recuperation take on all sorts of possibilities, of eventual varieties.

It is here, to give a sense which is not of the order of trickery, of conjuring, of magic, to the function of the mirror, I mean in this dialectic about the recognition of what we contribute or not with desire, that it is worthwhile making some remarks, the first of which is that in a fashion which I would ask you to note does not mean taking the path of idealism, therefore the first is this remark that the eye is already a mirror, that the eye, I would go so far as to say, organises the world in space, that it reflects what in the mirror is reflection, but which reflection is visible to the most piercing eye, the reflection that it itself carries of the world in this eye that it sees in the mirror, that in a word there is no need (14) for two opposing mirrors for there to be already created the infinite reflections of the hall of mirrors.

This remark about the infinite deployment of inter-reflected images, which are produced once there is an eye and a mirror, is not here simply for the ingeniousness of the remark, which one cannot see too well moreover where it would end up, but on the contrary to bring us back to the privileged point which is at the origin, which is the same as the one in which there is bound up the original difficulty of arithmetic, the foundation of the one and the zero.

The one image, the one which is made in the eye, I mean the one that you can see in the pupil, requires from the beginning of

this development a correlate which for its part is not an image at all. If the surface of the mirror is not there to support the world, it is not because nothing reflects this world, the consequences of which we have to draw, it is not because the world vanishes with the absence of the subject, it is properly what I said in my first formula: it is that nothing is reflected; that means that before space, there is a one which contains multiplicity as such, which is prior to the deployment of space as such, which is never anything but a chosen space where there can only be sustained juxtaposed things as long as there is room. Whether this room is indefinite or infinite does nothing to change the question. But in order to make you understand what I mean as regards this one which is not mono but poly, all in the plural - I will simply show you what you can see at Kamakura - it is the work of a sculptor whose name is well known; Kamakura is up to the end of the 12th century - : it is Buddha represented, materially represented by a statue three metres high, and materially represented by a thousand others. It creates a certain impression, and all the more so because one passes in front of them along a rather narrow corridor and a thousand statues take up some room, especially when they are all of human size, perfectly made and individualised; this work took the sculptor and his school a hundred years. You are going to be able to consider from the front and here from an oblique perspective the effect that has as you advance along the corridor.

This is done to materialise before you that the monotheism-polytheism opposition is perhaps not something as clear as it is usually represented for you. For the thousand and one statues which are there are all properly and identically the same Buddha. Besides, by right, each one of you is a Buddha, I say by right (15) because for particular reasons you may have been thrown into the world with some defect which may constitute a more or less irreducible obstacle to gaining access to it.

It nevertheless remains that this identity of the subjective one in its multiplicity, its infinite variability, to a final one with its completed access to non-dualism, in its access to the beyond of every pathetic variation, to the beyond of every cosmic wordly change, is something in which we have less reason to interest ourselves in as a phenomenon, than the fact that it allows us to approach the relationships that it demonstrates by the consequences that it had historically, structurally in the thoughts of men.

In truth, I said that what is there under a thousand and one supports, in reality these thousand and one supports, thanks to the effects of multiplication inscribed in what you can see, the multiplicity of their arms and of some heads which crown the central head, ought to be multiplied in such a way that there are in reality here 33,333 of the same identical beings. This is only a detail.

I told you what a Buddha was. It is not absolutely speaking a God, it is a bodhisattva, which means to go quickly and create a

void, as I might say, an almost Buddha. It would be completely a Buddha if precisely it was not there; but since it is there, and under this multiplied form, which has demanded, as you see, a lot of trouble, this is only the image of the trouble that he for his part takes to be there. He is there for you. He is a Buddha who has not yet succeeded in disinteresting himself, no doubt because of one of these obstacles to which I alluded earlier, to disinterest himself in the salvation of humanity. That is the reason why, if you are Buddhists, you prostrate yourself before this sumptuous gathering. It is because in effect you owe, I think, recognition to the unity which has troubled itself in such a great number to remain within range of bringing you help. For there is also said - the iconography enumerates it - the cases in which they will bring you help.

The bodhisattva in question is called in Sanscrit - you have already heard tell of him, I hope; his name is widely known, especially in our own day; all of this turns around this sphere vaguely called the element for anyone who does yoga - the bodhisattva in question here is Avalokitesvara.

The first image, the one of the statue that I passed around among you, is a historical avatar of this Avalokitesvara. I thus took (16) the right path before becoming interested in Japanese. Fate decreed that I should have elucidated with my good master Demieville, in the years when psychoanalysis allowed me more leisure, this book, this book which is called The lotus and the true law which was written in Chinese to translate a Sanscrit text by Kumarajiva. This text is more or less the historical turning point at which there appears the avatar, the singular metamorphosis that I am going to ask you to remember, namely that this bodhisattva, Avalokitesvara, the one who hears the tears of the world, is transformed from the time of Kumarajiva, who seems to be a little responsible for it, is transformed into a female divinity. This female divinity with whom I think you are also ever so little in accord with, in harmony with, is called Kuan-yin or again Kuan-shih-yin, this is also the meaning that Avalokitesvara has: it is the one who considers, who goes, who is in agreement. That is Kuan; this is the word I spoke to you about earlier and that is her wailing or her tears. Kuan-shih-yin - the "shih" can sometimes be effaced - the Kuan-yin is a female divinity. In China there is no ambiguity: the Kuan-yin always appears in a female form and it is at this transformation and on this transformation that I would ask you to dwell for a moment. In Japan these same words are written Kannon or Kann-ze-non, according to whether one inserts there or not the character of the world. Not all the forms of Kannon are feminine. I would even say that the majority of them are not. And because you have before your eyes the image of the statues of this temple, the same sanctity, divinity - a term which is to be left in suspense here - which is represented in this multiple form, you can see that the characters are provided with little moustaches and with tiny outlines of beards. Here therefore they are in a masculine form, which corresponds in effect to the canonical structure these statues represent, the number of arms and of heads involved.

But it is exactly the same being that is involved as in the first statue whose representations I circulated among you. It is even this form which is specified, can be seen as "Nio-i-Yin", Kannon or Kann-ze-non. "Nio-i-yin" in this case, which is therefore to be remembered here - there is a character which is going to be a little stifled, but after all not too much so - "Nio-i-yin" means "like the wheel of desires". It is exactly the meaning that its correspondent in Sanscrit has.

Here then is what we find ourselves confronted with: what is (17) involved is rediscovering in the most well-attested fashion the assimilation of pre-Buddhic divinities into the different stages of this hierarchy which thenceforth is articulated as the levels, the stages, the forms of access to the final realisation of beauty, namely to the final understanding of the radically illusory character of all desire.

Nevertheless within what one might call this multiplicity converging towards a centre, which is in essence a centre of nowhere, you see here reappearing, reemerging, I would say almost in the most incarnated fashion, what can be described as most living, most real, most animated, most human, most pathetic in a first relationship to the divine world, for its part essentially nourished and as it were punctuated by all the variations of desire, that [in] which the divinity, as one might say, or the Holiness with a capital H, which is almost the most central for acceding to beauty, is incarnated in the shape of the female divinity which has gone so far as to be identified at the origin with neither more nor less than the re-appearance of the Indian Shakti, namely something which is identical to the female principle of the world, the soul of the world; this is something which ought to make us pause for a moment.

In a word, I do not know whether this statue, the photographs of which I brought you, has succeeded in establishing for you this vibration, this communication in whose presence I assure you one can be sensitive, one can be sensitive not simply because as chance would have it accompanied by my guide, who is one of those Japanese for whom neither Maupassant nor Merimee have any secrets, nor indeed anything else in our literature - I will pass over Valéry because people talk about nothing else but Valéry all over the world, the success of this Mallarmé of the nouveaux riches is one of the most troubling things that one can meet with in our time; therefore let us recover our serenity - I enter the little hall where this statue is and I find there on his knees a man of thirty to thirty-five years old, a sort of very low-grade employee, perhaps a craftsman, already really very worn out by existence. He was on his knees before this statue and obviously he was praying. This after all is not something that we would be tempted to participate in. But after having prayed, he came very close to the statue - because there is nothing to prevent it being touched on the right, on the left and underneath - he looked at it in this way for a time that I could not measure, I did not really see the end of it, it was superimposed itself on the time of my own look. It was obviously an overflowing look (18) whose character was all the more extraordinary because it

was a matter there, not I would say of an ordinary man - because a man who behaves in this way could not be such - but of someone that nothing seemed to predestine, if only because of the evident burden that he was carrying on this shoulders from his work, for this sort of artistic communion.

The other volet of this apprehension I am going to give you in another form. You have seen the statue, its face, this expression which is absolutely astonishing because of the fact that it is impossible to read in it whether it is completely for you or completely inward looking. I did not know then that it was a Nio-i-yin, Kan-ze-non but I had heard tell for a long time of the Kuan-yin. I asked in connection with this statue and in connection with others also, "Is it a man or a woman?" I will skip over the debates, the detours of what happened around this question which is full of meaning, I repeat, in Japan, given that the Kannon are not all in a univocal fashion in a female form. And it is there that I can say that what I collected is a little bit like a survey at the level of the Kinsey Report, the fact is that I acquired the certainty that, for this cultured young man, familiar with Merimee and Maupassant and for a great number of his friends whom I questioned, the question before a statue of this kind, as to whether it is male or female, never arose for them.

I think there is here a highly important fact for tackling what we could call the variety of solutions with respect to the problem of the object, of an object which I think I have sufficiently shown you, by everything that I have just told you about my first approach to this object, the degree to which it is an object for desire. Because if you still need other details, you can notice that there is no opening of the eyes in this statue. Now the Buddhist statues always have an eye which one cannot describe as being either closed or half-closed - it is a position of the eye which can only be acquired by learning: it is a lowered lid which only allows to pass through a line of the white of the eye and an edge of the pupil - all the statues of Buddha are realised in this way. You have been able to see that this statue has nothing of this kind: it has simply, at the level of the eye, a kind of sharp ridge which means moreover that with the reflection of the wood, it always seems that there is an eye operating above, but nothing in the wood corresponds to it. I assure you that I carefully examined the wood, I informed myself, and the solution that I was given, without being able myself to settle how much faith should be accorded it, it was given to me by someone who is very specialised, very serious, Professor Hando to give him his name, the fact is that this split of the eye on this statue disappeared in the course of the centuries because of the rubbing it undergoes I think more or less daily at the hands of the nuns of the convent, of which it is the most precious treasure, when they want to wipe away the tears from this figure par excellence of divine recourse. Besides, the whole statue is treated in the same fashion as this edge of the eye by the hands of the religious, and represents in its polish this unbelievable something of which the photo here can only give you a vague reflection of what is the inverted radiation onto it of what one

cannot fail to recognise as something like a long desire borne throughout the centuries by these recluses towards this divinity of psychologically indeterminable sex.

I think that this - the time today has advanced far enough for me not to take my discourse here any further - will allow us to illuminate this passage to which we have now come.

There is at the oral stage a certain relationship between demand and the veiled desire of the mother; there is at the anal stage, the coming into play for desire of the demand of the mother; there is at the stage of phallic castration, the "minus-phallus" the entry of negativity with respect to the instrument of desire at the moment of the arousal of sexual desire as such in the field of the other. But the limit at which we ought to rediscover the structure of *o* as separated does not stop for us here at these three stages. It is not for nothing that today I spoke to you about a mirror, not about the mirror of the mirror stage, of narcissistic experience, of the image of the body as a whole, but of the mirror in so far as it is this field of the Other where there must appear for the first time, if not the *o*, at least its place, in short the radical mainspring which causes the passage from the level of castration to the mirage of the object of desire.

What is the function of castration in this strange fact that the most moving type of object, because it is at once our image and something else, can appear at this level in a certain context, in a certain culture as being unrelated to sex, here is the fact, which I believe to be characteristic, to which I intended leading you today.

Seminar 18: Wednesday 15 May 1963

If we begin from the function of the object in Freudian theory, the oral object, the anal object, the phallic object - you know that I question whether the genital object is homogeneous with the series - everything that I already initiated, as much in my past teaching as more especially in that of last year, indicates to you that this object defined in its function by its place as o, the remainder of the dialectic between the subject and the Other, that the list of these objects ought to be completed. It is quite sure that we have to define the object o, functioning as a remainder of this dialectic, in the field of desire at other levels about which I have already indicated enough for you to sense, if you wish, that in general it is some cut happening in the field of the eye, of which the desire attached to the image is a function. Another thing, beyond what we know already and where we rediscover this character of fundamental certainty already located by traditional philosophy and articulated by Kant in the shape of consciousness, the fact is that this method of approach in the shape of o will allow us to situate in its place what up to now has appeared as enigmatic in the shape of a certain imperative described as categorical.

The path along which we are proceeding, which revivifies this whole dialectic by our very approach, namely desire, this path along which we are proceeding this year, which is anxiety, I chose because it is the only one which allows us to produce, to introduce a new clarity as regards the function of the object with respect to desire.

How - this is what my last lecture was intended to presentify before you - how was a whole field of human experience, an experience which puts itself forward as that of a form, of a sort of salvation, the Buddhist experience, able to posit at its origin that desire is illusion? What does that mean? It is easy to smile at the rapidity of the assertion that everything is nothing. Moreover, as I told you, this is not what is involved in Buddhism.

But if for our experience also this assertion that desire is only illusion can have a sense, it is a matter of knowing where the sense can be introduced and in a word where the lure is.

I teach you to locate desire, to link it to the function of the cut, to put it in a certain relation with the function of the

remainder. This remainder is what sustains it, what animates it (2) and it is what we learn to locate in the analytic function of the partial object.

Nevertheless the lack to which satisfaction is linked is a different thing. This distance between the locus of the lack in its relationship to desire as structured by the phantasy, by the vacillation of the subject in his relationship to the partial object, this non-coincidence between the lack that is involved and the function of desire, as I might say, in act, is what creates anxiety, and anxiety alone finds itself aiming at the truth of this lack. This is why at every level, at every stage of the structuring of desire, if we wish to understand what is involved in this function of desire, we ought to locate what I will call the anxiety point (le point d'angoisse).

This is going to make us retrace our steps a little, and in a movement determined by all our experience, because everything happens as if, having come with Freud's experience face to face with an impasse, an impasse which I put forward as being only apparent and up to now never broken through, that of the castration complex, everything happens as if this obstacle which has to be explained - which perhaps will allow us today to conclude on some affirmation regarding what is meant by Freud's being brought to a halt on the castration complex - and for the moment let us remember its consequences in analytic theory: something like a reflux, like a return which leads the theory to search in the final resort for the most radical functioning of the drive at the oral level.

It is a singular fact that in analysis, a glimpse which initially was that of the nodal function of what is properly sexual in the whole formation of desire, has been led more and more in the course of its historical evolution to search for the origin of all the accidents, of all the anomalies, of all the gaps which can be produced at the level of the structuring of desire in something which is not fully explained by saying that it is chronologically original, the oral drive, but which must still be justified as structurally original, it is to it that when all is said and done, we ought to bring back the origin and the aetiology of all the difficulties that we have to deal with.

Moreover I have already tackled what, I believe, ought to reopen for us the question of this reduction to the oral drive, in showing the way it currently functions, namely as a metaphorical mode of tackling what is happening at the level of the phallic object, a metaphor which allows there to be eluded the impasse created by the fact, which was never resolved by Freud in the (3) final term, of what the functioning of the castration complex is, which veils it in a way, which allows it to be spoken of without encountering the impasse.

But if the metaphor is correct, we ought, at its very level, to see the beginnings of what is involved, of what explains why it is here only a metaphor. And that is why it is at the level of this oral drive that once already I tried to take up the relative

function of the cut of the object, of the locus of satisfaction and of anxiety, to take the step which is now proposed to us, the one that I led you to the last time, namely the point of junction between the o functioning as ($-\langle P \rangle$), namely the castration complex and this level that we will call visual or spatial, according to the aspect we are going to envisage it under, which is properly speaking the one where we can best see what the lure of desire means. In order to make this passage, which is our goal today, work, we ought for a moment make a backwards reference, return to the analysis of the oral drive, to ask ourselves, to specify clearly where at this level the function of the cut is. The nursing and the breast, it is around these that there have come to be confronted for us all the clouds of analytic theatre, the origin of the first aggressive drives, their reflection, indeed their retortion, the source of the most fundamental handicaps in the libidinal development of the subject. Let us therefore take up this thematic which - it ought not to be forgotten - is founded on an original act, essential for the biological subsistence of the subject in the order of mammals, that of sucking.

What is it about, what is it that functions in sucking? Apparently the lips, the lips in which we rediscover the functioning of what has appeared to us as essential in the structure of erotogeneity, the function of an edge.

That the lip presents the appearance of something which is, in a way the very image of the edge, of the cut, this is in effect something that ought to indicate to us, after I tried to picture, to define o for you last year in the topology, here is something which ought to make us sense that we are on solid ground.

Moreover it is clear that the lip, itself the incarnation, as one might say of a cut, that the lip in a singular way evokes what (4) exists at a quite different level, at the level of signifying articulation, at the level of the most fundamental phonemes, those most linked to the cut, the consonantal elements of the phoneme, the suspension of a cut, being for their most basic stock essentially modulated at the level of the lips.

I will return perhaps, if we have the time, to what I already indicated on several occasions about the question of fundamental words and their apparent specificity, "mama" and "papa". These are in any case labial articulations, even if something may put in doubt their apparently specific, apparently general, if not universal distribution.

That the lip, on the other hand, should be the place where symbolically, there can be grasped in the form of a ritual, the function of the cut, that the lip should be something which can be at the level of initiation rites, pierced, spread out, triturated in a thousand different ways, is also something which provides us with a reference that we are indeed in a living field and one recognised for a long time in human practices.

Is that all? There is behind the lip what Homer called the

enclosure of the teeth and of the bite. It is around this that what we bring into play, in the way that with the dialectic of the oral drive we brandish its aggressive thematic, the phantastical isolation of the extremity of the breast, of the nipple, this virtual bite implied by the existence of what is called a lacteal dentition, here is the thing around which we have to make revolve the possibility of the phantasy of the extremity of the breast as isolated, something which already presents itself as an object that is not simply partial but sectioned. It is through this that there are introduced into the first phantasies which allow me to conceive of the function of fragmentation as inaugural, this is in truth what we have been content with up to this.

Does that mean that we can maintain this position? As you know, since I already emphasised in a seminar which was, if I remember rightly, the one that I gave on 6 March, how the whole dialectic of what is called weaning, of separation ought to be taken up again in function even of what our experience has allowed us to enlarge, has appeared to us as its resonances, as its natural reverberations, namely weaning and the primordial separation, namely that of birth. And that of birth, if we look at it closely, if we put a bit more physiology into it, is something (5) well designed to illuminate things for us.

The cut, as I told you, is somewhere other than where we put it. It is not conditioned by aggression towards the maternal body. The cut, as analysis teaches us, if we hold - and quite correctly so - if we have recognised in our experience that there is an analogy between oral weaning and the weaning of birth, the cut is inside the individual, primordial unity as it is presented at the level of birth, where the cut is made between what is going to become the individual thrown into the outside world and these envelopes which form part of himself, which are qua elements of the egg homogeneous with what has been produced in ovular development, which are the direct prolongation of his ectoderm, as of his endoderm, which form part of himself, the separation is made inside the unit of the egg.

Now the emphasis that I intend to put here, depends on the specificity in the organismic structure of what is called the mammal organisation. That which, for almost the totality of mammals, specifies the development of the egg, is the existence of the placenta and even of a very special type of placenta, the one that is called chorio-allantoidian, the one by means of which for a whole phase of its development the egg in its intra-uterine position presents itself in a semi-parasitic relationship to the organism of the mother.

There is something suggestive, indicative for us in the study of the totality of this mammal organisation. At a certain level of the appearance of this organismic structure, specifically that of two orders, as one might say, that are called the most primitive of the class of mammals, the one specifically of the monotremes and the marsupials. We have the notion in the case of the marsupials of the existence of a different type of placenta,

which is not chorio-allantoid, but chorio-vitellin. We will not dwell on this nuance; but in the monotremes - I think that since childhood you have at least an image of them in the shape of these animals which in the Petit Larousse swarm in troops, as if they were pressing at the door of a new Noah's Ark, namely that there are two, and sometimes only one of them per species; you have the ornithorhynchus and also the image of what is called the echinoidea type. They are mammals. They are mammals in whom (6) the egg, even though placed in the uterus, has no placental relationship with the maternal organism. The mammary nevertheless already exists, the mammary in its essential relationship as defining the relationship of the offspring to the mother, the mammary already exists at the level of the monotremes, of the ornithorhynchus and allows there to be seen better at this level what its original function is. To clarify immediately what I intend to say here, I would say that the mammary presents itself as something intermediary, and that it is necessary for us to conceive that the cut lies between the mammary and the maternal organism. Even before the placenta shows us that the nourishing relationship at a certain level of the living organism is prolonged beyond the function of the egg which, charged with all the baggage which allows its development, will make the infant rejoin his begetters in a common experience of seeking for food, we have this function of the relationship that I have called parasitic, this ambiguous function where there intervenes this amboceptor organ; the relationship of the child in other words to the mammary, is homologous - and what allows us to say it, is that it is more primitive than the appearance of the placenta - is homologous with something which means that there is on one side the child and the mammary and that the mammary is in a certain way stuck onto, implanted on the mother; it is this which allows the mammary to function structurally at the level of o.

It is because the o is something from which the child is separated in a fashion that is in a way internal to the sphere of his own existence, that it is well and truly the small o.

You are going to see what results as a consequence of this: the link of the oral drive is made to this amboceptor object. What constitutes the object of the oral drive is what we usually call the partial object, the mother's breast. Where at this level is what I earlier called the anxiety point? It is precisely beyond this sphere. For the anxiety point is at the level of the mother. The anxiety of the lack of the mother in the child, is the anxiety about the drying up of the breast. The anxiety point is not confused with the locus of the relation to the object of desire.

The thing is imaged in a singular way by these animals that in a quite unexpected way I brought out here effectively in the shape of these representatives of the order of monotremes. Everything happens as if this image of biological organisation had been fabricated by some farseeing creator in order to manifest for us the true relationship which exists at the level of the oral drive (7) with this privileged object which the mammary is. For,

whether you know it or not, the small ornithorhynchus, after its birth, spends a some time outside the cloaca in a place situated on the stomach of the mother called the incubatorium. It is still at that time in its envelopes, which are the envelopes of a sort of hard egg from which it emerges, from which it emerges with the help of a tooth called a hatching tooth reduplicated, because one must be precise, with something which is situated at the level of the upper lip and which is called the caronculus.

These organs are not special to it. They exist already before the appearance of mammals; these organs which allow a foetus to emerge from the egg exist already at the level of the snake where they are specialised, snakes only having, if I remember rightly, the hatching tooth while the other varieties of reptiles more exactly - they are not snakes - namely tortoises and crocodiles have only the caronculus.

The important thing is the following: it seems that the mammary, the mammary of the mother of the ornithorhynchus, needs the stimulation of this little armoured point that the muzzle of the little ornithorhynchus presents, to unleash, as one might say, its organisation and its function and that it seems that for a week or so it is necessary for this little ornithorhynchus to work at the unleashing of that which appears indeed much more dependent on his presence, on his activity than on something which belongs as a matter of fact to the organism of the mother, for that matter besides, it gives us curiously the image of a relationship in a way the inverse of the one of the mammary protuberance, because these mammaries of the ornithorhynchus are mammaries of a hollow kind into which the beak of the baby is inserted. Here more or less is the place where the glandular elements, the milk-producing lobules exist. It is here that this snout which is already armoured, which has not yet hardened in the form of a beak as it will later become, that this snout comes to lodge itself.

The existence, therefore, of the distinction between two original points in the mammal organisation, the relationship to the mammary as such will remain structuring for the subsistence, the support of the relationship to desire, for the maintenance of the mammary specifically as an object which will subsequently become the phantastical object, and on the other hand the situation moreover in the Other, at the level of the mother and in a way not coinciding, displaced, of the anxiety point as being that by which the subject has a relationship with what is involved, with his lack, with what he is suspended on, the existence of the (8) mother's organism, is what we may be allowed to structure in a more articulated fashion by this simple consideration of a physiology which shows us that the o is an object separated from the child's organism, that the relationship to the mother is at this level no doubt an essential relationship which is isolated with respect to this organismic totality where the o is separated, and is moreover miscognised as such as having isolated itself from this organism, this relationship to the mother, the relationship of lack is situated beyond the locus where there has been played out the distinction of the partial object as

functioning in the relationship of desire.

Of course the relationship is still more complex and the existence in the function of sucking on the side of the lips, the existence of this enigmatic organ which has long been noted as such - remember Aesop's fable - which is the tongue, also allows us to bring into play at this level the something which in the underpinnings of our analysis is there to nourish the homology with the phallic function and its singular asymmetry, one to which we will return in a moment, namely that the tongue plays in sucking this essential role of functioning through what one can call aspiration, supports a void, whose power of appeal is essentially what allows the function to be effective, and on the other hand to be this something which can give us the image of the most intimate emergence, of this secret of sucking, to give us in a first form this something which will remain - I have marked it out for you - in the state of phantasy, at bottom everything that we can articulate around the phallic function, namely the turning inside-out of a glove, the possibility of an eversion of what is at the most profound point of the secret of the interior.

That the anxiety point is beyond the locus where there operates the function, the locus where the phantasy is fixed in its essential relationship to the partial object, this is what appears in this prolongation of the phantasy which is an image that always remains more or less as an underlay to the credence we put in a certain mode of oral relationship, the one which is expressed in the image of a function described as vampirism.

It is true that if in one or other mode of his relationship to the mother the child is a little vampire, if he poses himself as an organism suspended for a time in the parasitic position, it nevertheless remains that he is not this vampire either, namely that at no moment is it with his teeth, or at source that he is going to search in the mother for the hot and living source of his food.

(9) Nevertheless the image of the vampire, however mythical it may be, is there to reveal to us, by the aura of anxiety that surrounds it, the truth of this relationship beyond, which is profiled in the relationship of the message, the one which gives it its most profound accent, the one which adds the dimension of the possibility of the realised lack beyond what anxiety conceals in terms of virtual fears - the drying up of the breast. What puts in question the function of the mother as such, is a relationship which is distinguished, in so far as it is profiled in the image of vampirism, is distinguished as an anxiety-provoking relationship. A distinction therefore, I underline it well, between the reality of organismic functioning and what is outlined of it beyond, this is what is going to allow us to distinguish the anxiety point from the point of desire. Which shows us that at the level of the oral drive the anxiety point is at the level of the Other, that it is there that we experience it.

Freud tells us: "Anatomy is destiny". As you know, I have rebelled at certain moments against this formula because of its incompleteness. It becomes true, as you see, if we give to the term "anatomy" its strict and, I might say, etymological sense, the one which highlights - ana-tomy - the function of the cut, which means that everything that we know about anatomy is linked to vivisection. And in so far as there is conceivable this fragmentation, this cutting of one's own body, which there is the locus of elective moments of functioning, it is in so far as destiny, namely the relationship of man to this function which is called desire, takes on all its animation.

The fundamental "separation", not separation, but partition within, this is what is found at the origin and from the level from the oral drive on, inscribed in what will be the structuring of desire. Hence the astonishment at the fact that we have gone to this level to find some more accessible image for what has always remained for us - and why? - a paradox up to now, namely that in phallic functioning, in the one linked to copulation, it is also the image of a cut, of a separation, of what we improperly call castration, because it is an image of gelding that functions. It is no doubt not by chance, nor no doubt in a misguided way, that we went searching in older phantasies for the justification of what we did not know very well how to justify at the level of the phallic phase, it must nevertheless be noted that at this level something has been produced which is going to (10) allow us to find our bearings in the whole subsequent dialectic.

How in effect, as I have just announced it to you, how in effect has there occurred the division, that I have taught you to distinguish at the topological level, between desire, between its function, and anxiety? The anxiety point is at the level of the

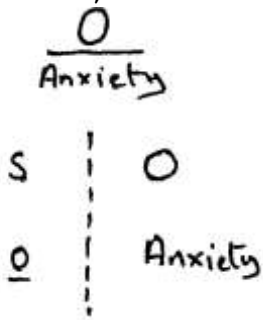

Other, at the level of the body of the mother. The functioning of desire, namely of phantasy, of the vacillation which closely unites the subject to o, that through which the subject finds himself essentially suspended, identified with this always elided, always hidden o, that we have to detect underpinning every relationship of the subject to any object whatsoever. You see it here, and to call arbitrarily here S the

level of the subject, that which in my schema, if you wish, my schema of the vase reflected in the mirror of the Other, is found on the hither side of the mirror, here is where at the level of the oral drive the relationships are found.

The cut, as I told you, is inside the field of the subject; desire functions - we rediscover here the Freudian notion of autoerotism - inside a world which, even though fragmented, bears the trace of its first enclosure within what remains imaginary, virtual, the envelope of the egg.

What is going to happen to it at the level that the castration complex is produced? At this level we witness a veritable

reversal of the point of desire and the locus of anxiety. If something is promoted by the no doubt still imperfect style, but one charged with all the relief of a painful conquest, made step by step, and this since the origin of the Freudian discovery, which revealed it in the structure, it is the close relationship between castration, between the relation to the object in the phallic relationship, as an implicit container of the privation of the organ.

If there were no Other - and it does not matter whether we should call this Other here the castrating mother or the father of the original prohibition - there would be no castration.

The essential relationship henceforth between castration and all copulatory functioning has already urged us to try - after all, following the indication of Freud himself who indeed told us, without justifying it in any way, that at this level it is some biological rock that we are touching - has thus stimulated us to (11) articulate as lying in a particularity of the function of the copulatory organ at a certain biological level - I pointed out to you at other levels, in other orders, in other animal branches, the copulatory organ is a hook, it is an organ of fixation, and can be called the male organ in the most summarily analogical fashion - it sufficiently indicates to us that it is important to distinguish the particular functioning, at the level of the organisations of what are called superior animals, of this copulatory organ; it is essential not to confuse its avatars, specifically the mechanism of tumescence and of detumescence, with something that is, in itself, essential for orgasm.

Without any doubt we find ourselves here, as I might say, in what could be called an imitation of experience. We are not going, as I have already told you, to try to conceive of what orgasm may be in a copulatory relationship that is differently structured. Besides there are enough impressive natural spectacles; it is enough for you to take a stroll some evening on the edge of a pond to see two dragonflies flying closely intertwined and this spectacle alone says enough about what we can conceive of as being a "long-orgasm" if you will allow me to construct a word, by inserting a hyphen. And moreover it is not for nothing that I evoked here the phantastical image of the vampire which is not at all dreamt of or conceived of by human imagination otherwise than as this mode of fusion or of primary subtraction at the very source of life, where the aggressor subject can find the source of his jouissance. Undoubtedly the very existence of the mechanism of detumescence in the copulation of organisms most analogous to the human organism, is already sufficient by itself to mark the link between orgasm and something which well and truly presents itself as the first image, outline, of what can be called the cut, separation, weakening, aphanisis, disappearance at a certain moment of the function of the organ.

But then, if we take things from this angle, we will recognise that the homologue of the anxiety point in this case is found in a strictly inverted position to the one where it was found at the level of the oral drive; the homologue of the anxiety point is

the orgasm itself as a subjective experience. And this is what allows us to justify what clinical experience shows us very frequently, the sort of fundamental equivalence there is between orgasm and at least certain forms of anxiety. The possibility of (12) the production of an orgasm at the high point of an anxiety-provoking situation, the eroticisation, we are told from every side, the eventual eroticisation of an anxiety-provoking situation sought for as such, and inversely a mode of clarifying, which means that if we believe the universally renewed human testimony - it is worth the trouble after all to note that someone and someone of Freud's level dares to write it - the attestation of this fact that there is nothing which when all is said and done, which represents, when all is said and done, for the human being a greater satisfaction than orgasm itself, a satisfaction which undoubtedly goes beyond, because it can be articulated in this way, as being not simply put in the balance, but to be given the function of primacy and precedence with respect to anything that man is given to experience. If the function of the orgasm can reach this eminence, is it not because at the basis of the realised orgasm there is something that I called the certainty linked to anxiety, is it not in the measure that the orgasm is the very realisation of what anxiety indicates as a point of reference, as a direction of the locus of certainty, that the orgasm, among all anxieties, is the only one which is really completed. Moreover, it is indeed for this reason that orgasm is not such a common attainment and that, if we may be permitted to indicate its eventual function in the sex in which there is precisely no phallic reality except in the form of a shadow, it is also in this very sex that orgasm remains for us most enigmatic, most shut off, and perhaps up to now never authentically situated in its final essence.

What is indicated to us by this parallel, this symmetry, this reversion established in the relationship between the anxiety point and the point of desire, if not that in neither of the two cases do they coincide. And it is here, no doubt, that we ought to see the source of the enigma that is bequeathed to us by Freudian experience.

In the whole measure that the situation of desire virtually implied in our experience, whose entire texture as I might say is not nevertheless truly articulated in Freud, the end of analysis comes up against something which makes the sign implied in the phallic relationship take on its form: the ($\langle p \rangle$) in so far as it functions structurally as ($-\langle \epsilon \rangle$) which makes it take on this form while being the essential correlate of satisfaction.

If at the end of Freudian analysis the patient whoever he may be, (13) male or female, lays claim to the phallus that we owe him, it is in function of this insufficiency through which the relationship of desire to the object which is fundamental, is not distinguished at every level from what is involved as a lack constitutive of satisfaction.

Desire is illusory. Why? Because it is always addressed elsewhere, to a remainder, to a remainder constituted by the

relationship of the subject to the Other who comes to substitute himself there.

But this leaves open the locus where there can be found what we designate under the name of certainty. No fixed phallus, no omnipotent phallus is capable of closing the dialectic of the relationship of the subject to the Other and to the real by anything whatsoever that is of a pacifying order. Does that mean that if we touch here the structuring function of the lure, we ought to remain there, to admit that our impotence, our limit is the point where the distinction between finite and indefinite analysis is broken? I do not believe it is anything of the kind. And it is here that there intervenes what is concealed in the most secret core of what I put forward a long time ago before you in the form of the mirror stage, and which obliges us to try to order in the same relationship, desire, object and anxiety point, what is involved when there intervenes this new object o for which the last lecture was the introduction, the bringing into play, namely the eye.

Of course, this partial object is not new in analysis, and I will here only have to evoke the article of the most classic author, the one most universally accepted in analysis, namely Mr Fenichel, on the subject of the relationships of the scopophilic function to identification, and even the homologies that he is going to discover between the relationships of this function and the oral relationship.

Nevertheless everything that has been said on this subject can justly appear insufficient. The eye is not an affair which only refers us to the origin just of mammals or even of vertebrates or even of chordata; the eye appears in the animal scale in an extraordinarily differentiated fashion - and in its whole anatomical appearance essentially similar to the one that we have - at the level of organisms which have nothing in common with us.

There is no need - I already repeated it on several occasions, and the images that I tried to make functional - to recall that the eye exists at the level of the praying mantis, but also at the level, what is more at the level of the octopus. I mean the eye with this particularity about which we ought to introduce (14) from the beginning this remark: it is always a double organ, and an organ which in general functions in a dependency on a chiasma, namely that it is linked to the intersecting knot which links two parts of the body that we call "symmetrical".

The relationship of the eye to a more or less apparent symmetry - for no organism is entirely symmetrical - is something that ought to be taken into account by us in the highest degree. If there is something that my reflections of the last time, if you remember them, namely the radical function of the mirage which is included from the first functioning of the eye, this fact that the eye is already mirror and already implies in a way in its structure, the transcendental aesthetic foundation as one might say of a constituted space is something that must yield its place

to this: the fact is that, when we speak about this transcendental structure of space as an irreducible given of aesthetic apprehension of a certain field of the world, this structure only excludes one thing: that of the function of the eye itself, of what it is.

It is a matter of finding the traces of this excluded function which is already sufficiently indicated for us as a homologue of the function of *o* in the phenomenology of vision itself. Here we can only proceed by punctuation, indication, remark.

Undoubtedly for a long time all of those, specifically the mystics, who have attached themselves to what I could call the realism of desire, for whom every attempt to reach the essential is indicated as overcoming this glue-like stickiness that there is in an appearance which is always conceived of as visual appearance, these already put us on the path of something which moreover all sorts of natural phenomena bear witness to, namely the fact that, outside such a register, there remains enigmatic, namely, I am saying, what are called mimetic appearances which manifest themselves in the animal scale exactly at the same level, at the same point that the eye appears. At the level of insects where we might be astonished - why not - that a pair of eyes should be a pair constructed like our own, at the same level there appears this existence of a double stain which the physiologists, whether they are evolutionists or not, torment themselves about by asking what is it that can condition something whose functioning in any case is that of exercising a fascination on the other whether it is a predator or not.

The linking of the pair of eyes and, if you wish, the look, to an (15) element of fascination that is enigmatic in itself, to this intermediary point at which every subjective subsistence seems to be lost and to be absorbed, to go out of the world, this indeed is what is called fascination in the function of the look. Here is, if I may say, the point of radiation which allows us to put in question what the field of vision reveals to us in the function of desire. Moreover it is striking that in the attempt to apprehend, to reason, to logicize the mystery of the eye, and this at the level of all those who have attached themselves to this form of major capture of human desire, the phantasy of the third eye is everywhere manifest. I do not need to tell you, that on the images of the Buddha which I gave an account of the last time, the third eye in some manner is always indicated. Do I need to remind you that this third eye which is promulgated, promoted, articulated in the most ancient magico-religious tradition, that this third eye rebounds up to the level of Descartes who, a curious thing, only finds its substratum in a regressive, rudimentary organ that of the epiphysis, of which one can say perhaps that at a point of the animal scale something appears, is realised, which will carry the trace of an ancient emergence. But this after all is only a reverie. We have no testimony, fossil or otherwise, of the existence of the emergence of this apparatus described as a third eye.

In this method of approaching the function of the partial object

which is the eye, in this new field of its relationship to desire, what appears as correlative of the small o function of the object of the phantasy, is something that we can call a zero point whose influence over the whole field of vision is what gives to this field, a source for us of a sort of pacification expressed for a long time, from earliest times, in the term contemplation, of suspension from the tearing apart of desire, a fragile suspension certainly, as fragile as a curtain always ready to be pulled back to unmask the mystery that it hides. This zero point towards which the image of the Buddha seems to carry us in the very measure that his lowered eyelids protect us from the fascination of the look while at the same time indicating to us this figure which in the visible is always turned towards the invisible, but who spares us it, this figure in a word takes entire charge of the point of anxiety here, it is not for nothing that it suspends, that it apparently cancels out the mystery of castration.

(16) This is what I wanted to indicate to you the last time by my remarks and the little survey that I had made about the apparent psychological ambiguity of these figures. Does that mean that there is in any way the possibility of entrusting oneself, of assuring oneself, in a sort of field which has been called Apollinian, you can see it also as noetic, contemplative, where desire could be supported by a sort of punctual cancellation from its central point, by an identification of o with this zero point between the two eyes which is the only locus of unease which remains, in our relationship to the world, when this world is a spatial world? Undoubtedly not, because precisely there remains this zero point which prevents us from finding in the formula of desire-illusion the final term of experience.

Here the point of desire and the anxiety point coincide, but they are not confused, they even leave open to us this "nevertheless" on which there eternally rebounds the dialectic of our apprehension of the world. And we always see it reemerging in our patients, and nevertheless - I looked to see how one says "nevertheless" in Hebrew, that will amuse you - and nevertheless this desire which here is resumed in the nullification of its central object, is not without this other object that summons anxiety: it is not without object. It is not for nothing that in this "not without, pas sans" I gave you the formula, the essential articulation of the identification to desire. It is beyond "it is not without an object" that there is posed for us the question of knowing where the impasse of the castration complex can be gone beyond. This is what we will tackle the next time.

Seminar 19: Wednesday 22 May 1963

Roughly speaking, to provide a summary orientation for someone who might arrive by chance in the middle of this discourse, I would say, that to complete, as I announced to you, what could be called the range (gamme) of object relations seen in the schema which is being developed this year around the experience of anxiety, he might think that we were required to add to the oral object, the anal object, the phallic object, precisely in so far as each one is generator of and correlative to a type of anxiety, two other stages of the object, bringing to five then these objectal stages in the measure that they will allow us to find our bearings this year.

You have, I think, sufficiently understood that for our last two meetings I have been dealing with the eye stage, I will not for all that leave it today but rather find my bearings from there by making you pass on to the stage that must be tackled today, that of the ear.

Naturally, as I told you, my first word was "roughly" and I repeated "summarily" in the following sentence, it would be completely absurd to believe that this is what is involved except in a grossly esoteric and obscurantist fashion.

It is a matter at all of these levels of mapping out what the function of desire is and none of them can be separated from the repercussions that it has on all the others and from a more intimate solidarity, the one expressed in the foundation of the subject in the Other along the path of the signifier, with the completion of this function of mapping out in the advent of a remainder around which there turns the drama of desire, a drama which would remain opaque to us if anxiety were not there in order to allow us to reveal its meaning.

This often leads us, apparently, to what I might call erudite kinds of digressions, in which certain people may see some charm or other to be experienced or reproved in my teaching. Believe me that it is not without reticence that I advance into them, and that moreover the method according to which I proceed in the teaching that I give here will be studied - it is surely not for me to spell out here its rigour - the day when people will search, in the texts that may exist, be transmissible, be still understood of what I am giving you here, it will be seen that this method is not essentially distinguished from the object which is being tackled.

(2) Only I remind you that it arises from a necessity. The truth of psychoanalysis is only, at least in part, accessible to the experience of the psychoanalyst. The very principle of a public teaching starts from the idea that it is nevertheless communicable elsewhere. This having been posited, nothing is resolved, since the psychoanalytic experience itself must be oriented, otherwise it goes astray. It goes astray if it becomes partial, as we have not ceased from the beginning of this teaching to point out in different parts of the analytic movement, specifically in that which, far from being a deepening, a complement given to the indications of Freud's last doctrine in the exploration of the mainsprings and of the status of the ego, far from being a continuation of his indications and of this work, we have seen there being produced what is properly speaking a deviation, a reduction, a veritable aberration of the field of experience, no doubt determined also by something that we can call a certain opacity which occurred in the first field of analytic exploration, the one which for us characterises, which is characterised by the style of illumination, the sort of brilliance which remains attached to the first decades of the diffusion of Freudian teaching, to the form of the researches of this first generation one of whom I will make intervene today more quickly still, Theodore Reik I believe, and specifically among the numerous and immense technical and clinical works, one of these works quite incorrectly described as applied psychoanalysis, the ones that he produced on ritual.

We will see in it - what is involved here specifically is the article which appeared in Imago somewhere, I think I remember around the eighth year, I think more or less, I forgot to bring the text here today, which appeared in Imago around the eighth year - I believe, on something whose name you see here written in Hebrew letters - a study on the shofar of such verve, of such brilliance, of such fecundity, of which one can say that the style, the promises, the characteristics of the epoch in which it is inscribed, saw themselves suddenly extinguished, that nothing equivalent to what was produced at that period went on afterwards. And therefore it has to be asked, why this interruption itself.

שֹׁפָר

shofar



The fact is though that, if you wish, in this article you will see there being manifested, I would say, despite all the praise that I might give to its penetration, to its high signification, you will see there being manifested to the highest degree this source of confusion, this profound lack of grounding whose most (3) tangible and most manifest form is in what I would call the purely analogical use of the symbol. I believe that I must first of all clarify what this shofar is, unsure as I am that everybody here knows what it designates. If I bring forward this object today, for it is an object which is going to serve me as a pivot, as an example, to materialise, to substantiate before you what I mean about the function of o, the object precisely at this stage, the final one, which in its functioning will allow us to reveal the function of sustentation which links desire to anxiety in what is its final knot.

You will understand why, rather than immediately naming what this object in function is, at a level which goes beyond that of the occultation of anxiety in desire, since it is linked to a ritual object, rather than naming it immediately you will understand why I approach it by handling an object, a ritual object, this shofar, which is what? A horn, a horn into which one blows and which allows a sound to be heard, which, undoubtedly, I can only say to those here who have not heard it, to treat themselves at the ritual detour of Jewish feasts, the ones which follow the New Year, which is called Rosh ha-Shanah, which end on the day of the Great Pardon, the Yom Kippur, to treat themselves to an audition, in the synagogue, of the thrice repeated sound of the shofar. This horn, which in German is called the Widderhorn, is also called the ram's horn, Quren ha yobel, in his commentary, his explanation in the Hebrew text. It is not always a ram's horn; besides these examples of it which are reproduced in Reik's text, which are three particularly precious and celebrated Shofars belonging- if I remember rightly, to the synagogues of London and of Amsterdam respectively, present themselves as objects whose general outline, which is more or less like this, makes one think rather of what it is, for this is how it is classically. The Jewish authors, who have been interested in this object, and have made a catalogue of the diverse shapes, note that there is a form of the shofar which is a sort of horn, which is made of the horn of a wild goat.

Naturally this object which undoubtedly has this appearance must much more probably- be the result of manufacture, of alteration, of reduction - who knows? It is an object of considerable length, bigger than the one that I am presenting for you there on the blackboard - the result therefore perhaps of the instrumentalisation of a goat's horn.

(4) Those then who have treated themselves, or who will treat themselves, to this experience will bear witness, I think, as is generally the case, to the character, to remain within limits which are not at all lyrical, to the profoundly moving, stirring character, to the arousal of an emotion whose resonances present themselves independently of the atmosphere of recollection, of faith, indeed of repentance in which it manifests itself, which resonates along the mysterious paths of properly auricular affect which cannot fail to touch to a really unusual, inhabitual degree all of those who come within range of hearing its sound.

Around the questioning which Reik carries on around the function of this shofar, one cannot fail to perceive - and this is what seems to me characteristic of the epoch to which this work belongs - to be struck at once by the relevance, by the subtlety, by the depth of the reflections with which this study teems. It is not simply strewn with them, really it produces them round about some centre or other of intuition, of flair. There is even the date that this appeared. No doubt we have since learnt perhaps by some resifting or other, also by the erosion of the method, the resonance of what is happening, of what emerges from these first blase works at the time - and I can bear witness to you of it - compared to everything that was produced in terms

of erudite works, and believe me: you know that everything I bring here is nourished on my part by what are often in appearance enquiries carried to the very limits of the superfluous. Believe me: because of the difference in effect of this mode of interrogating the biblical texts, those in which the shofar is named as correlative to the major circumstances of the revelation given to Israel, one cannot fail to be struck that Reik, from a position which in principle, at the very least repudiates all traditional attachments, indeed places itself even in an almost radical and critical position, not to say one of scepticism, how much much more profoundly than all the apparently more respectful commentators, the ones more careful to preserve the essential of a message goes for his part, goes more directly to what appears essentially to be the truth of the historical advent in these biblical passages which I ceaselessly evoked, and reported by them.

I will return to this. But it is nonetheless also striking, if you consult these articles, to see the degree to which at the end, he gets himself - and undoubtedly for want of any of these (5) theoretical supports which allow a style of study to give itself its proper limits - into inextricable confusion. It is not enough for the shofar and the voice that it supports to be presented as an analogy of the phallic function - and in effect why not - but how and at what level is where the question begins, it is also there that he comes to a halt. It is not enough that such an intuitive, analogical handling of the symbol, leaves the interpreter, at a certain limit, stripped of all criteria for there not to appear at the same time the degree to which there is telescoped together, the degree to which there turns into a sort of mixture and confusion that is properly speaking unnameable, everything that Theodore Reik ends up with at the final term in his last chapter. To give you an idea of it, I will only indicate to you that these points, step by step and through the intermediary precisely of the ram's horn, of the indication which is given to us by this of what is quite obvious, of the underpinning, more exactly of the correlation, why not say for that matter of the conflict with a whole reality, with a whole social totemic structure in the midst of which the whole historical adventure of Israel is plunged. How, along what path, how does it happen that no barrier stops Reik in his analysis to prevent him at the end from identifying Yahwe with the golden calf? Moses coming down from Sinai, radiating with the sublimity of the love of the father, had already killed him, and the proof, he tells us, is what he becomes: this veritable enraged being who is going to destroy the golden calf and make the Hebrews eat it in a powdered form. In this, of course, you will recognise the dimension of the totemic meal. The strangest thing, is that since the requirements of the proof have to pass through the identification of Yahwe not with a calf, but with a bull,, the calf in question will therefore necessarily represent a son-divinity alongside a father-divinity. We were told about the calf only to confuse the issue, to leave us in ignorance of the fact that there was also a bull. So therefore, since Moses here is the son, murderer of the father, what Moses has destroyed in the calf through the sequence of all the displacements followed

in a way that quite obviously makes us sense that we lack any reference points, any compass capable of orientating us, this is supposed to be therefore Moses' own ensign: everything is consumed in a sort of self-destruction. This is only indicated to you, I am only giving you here a certain number of points which show you the extremes at which a certain form of analysis can arrive by its excesses. We will have other examples in the (6) lectures which follow.

For our part, we are going to see what seems to us to deserve to be retained here, and for this reason to know, to know what we are searching for, this is what emerges from what I was introducing earlier as constituting the necessity of our research, namely not to abandon what in a certain text, which is none other, after all, than the foundational text of a society, my own, the one which is the reason why I am here in the position of giving you this teaching: the fact is that in the principle which determines the very necessity of a teaching, if there is in the first place the necessity of correctly situating psychoanalysis among the sciences, this can only happen by submitting its technique to the examination of what it really presupposes and accomplishes.

As regards this text, I indeed have the right to remember that I had to defend it and to impose it, even if those after all who allowed themselves to be drawn along by it saw in it perhaps nothing but empty words. This text appears to me to be fundamental; for what this technique presupposes and accomplishes in fact is our supporting point, the one around which we ought to make revolve the whole arrangement, even the structural one, of what we have to deploy.

If we overlook the fact that what is involved in our technique, is a handling, an interference, indeed at the limit a rectification of desire, but which leaves entirely open and in suspense the notion of desire itself and which necessitates its perpetual putting in question, we will undoubtedly, on the one hand wander about in the infinite network of the signifier or, going back to the beginning, relapse into the most ordinary paths of traditional psychology. What Reik discovers in the course of this study, which is also what he cannot draw any advantage from in his day, for want of knowing where to put the result of his discovery, is the following: he discovers through the analysis of biblical texts - I will not enumerate all of them for you - but those which are historical - I mean those which claim to refer to a revelatory event and are in The Book of Exodus in Chapter 19 and 20, respectively, verses 16 to 19 for Chapter 19, verse 18 for Chapter 20. It is said in this first reference that in this thundering dialogue carried on very enigmatically in a sort of tumult, a veritable storm of sounds between Moses and the Lord, there is mentioned the sound of the-shofar, an enigmatic fragment (7) of this verse also indicates that at that time it was severely prohibited, and not only for any man, but for any living being, to approach the circle surrounded by lightning and flashes, in which this dialogue is taking place. The people can go up when they hear the voice of the shofar.

A point that is so contradictory and enigmatic that in the translation the sense is weakened, and it is said that some can come up. As regards who, the affair remains obscure. The shofar is also expressly mentioned again after the description of the dialogue. It is the presence in everything that is perceived by the people who are supposed to be assembled around this major event, the sound of the shofar is mentioned again.

Reik's analysis which he cannot find anything to say to characterise, to justify, other than the following, which is that an analytic exploration consists in seeking the truth in details, undoubtedly this characteristic is neither false nor inexact, but we cannot fail to see that, if it is a sort of external criterion, that, if this is the assurance of a style, it is not for all that either something which carries in itself this critical element, that of discerning what detail ought to be retained.

Undoubtedly we have always known that this detail which guides us, is the very one which appears to escape even the intention of the author, appears to remain in a way opaque, shut off with respect to the intention of his preaching, but again it is not necessary to find among them a criterion, if not of hierarchy, at least of order, of precedence.

In any case, we cannot fail to sense - I am forced to go through the steps of his proof - that something correct is touched, as regards ordering, articulating, the fundamental original texts mentioning the function of the shofar, those which complete those of Exodus which I have just named for you which those of Samuel, the second book in Chapter VI, with those of the first book of Chronicles, Chapter XIII, the function of the shofar being mentioned every time it is a matter of refounding, of renewing in some new departure, whether it is periodic or whether it is historical, the alliance with God. The comparison of these texts with, in addition, other occasional uses of the instrument, at first those which are perpetuated in these feasts, annual feasts in so far as they themselves refer to the repetition, and the remembering properly speaking of the alliance, an exceptional occasion also, the function of the shofar in what is called the (8) ceremony of excommunication, the one under which, as you know, on 27 July 1656 Spinoza fell, was excluded from the Hebrew community according to the most complete forms, those which specifically involved, in addition to the formula of malediction pronounced by the high priest, the sounding of the shofar.

This shofar, through the illumination which is completed by bringing together different occasions when it is both signalled for us and effectively enters into operation, is well and truly - and nothing other, Reik tells us - than the voice of God, of Yahwe, I mean the voice of God himself.

This point, which does not appear from a quick reading to be something open to exploitation by us, takes on in a perspective which is the one precisely to which I am forming you here - for it is not the same thing to introduce some more or less

well-marked criterion or for these criteria moreover in their novelty, with the efficacy they involve, to constitute what is called a formation, that is to say a reformation of the mind in its capacity for tackling things.

Undoubtedly for us, such a formula can delay us only in so far as it makes us perceive something which completes the relationship of the subject to the signifier in what from a certain first grasp one could call his [its?] passage a l'acte.

Of course, I have here at the extreme left of the audience someone who cannot fail to be interested by this reference, it is our friend Stein, and I can tell you on this occasion the satisfaction I experienced in seeing that his analysis of Totem and Taboo, and of what can be retained for us in it, led him to this sort of necessity which makes him speak about something that he calls both primordial signifiers, and that he cannot detach at the same time from what he also calls act, namely what happens when the signifier is not simply articulated, which only supposes its liaison, its coherence with the others in a chain, but when it is properly speaking uttered and vocalised.

I, for my part, here, would have some, even many reservations about the introduction of the term act with no further commentary. I only want for the moment to retain the following which puts us in the presence of a certain form, not of the act, but of the object o in so far as we have learned to locate it, in so far as it is supported by this something which must be detached from the phonematisation as such, which is - linguistics has taught us to notice it - which is nothing other than a system of opposition with which it introduces (9) possibilities of substitution, of displacement, of metaphor and of metonymies, and which moreover is supported by any material whatsoever capable of being organised in these distinctive oppositions between one and all. The existence of the properly vocal dimension, of the passage to something of this system, into an utterance which is presented every time as isolated, and as a dimension in itself from the moment that we perceive into what there is plunged corporally the possibility of this dimension of utterance. And it is here that you will understand, if you have not already guessed it, that there takes on its value as an exemplary introduction - you can well imagine that it is not the only one that I could have made use of - this exemplary object which I took this time in the shofar, because it is within our reach, because it is, if it is truly what it is said to be, that it is at a source-point from which there sprang forth a tradition which is our own, because already one of our ancestors has busied himself with it and has highlighted it in analytic enunciating - but for that matter the tuba, the trumpet, and other instruments - for it is not necessary, even though it cannot be just any instrument whatsoever, that it should be a wind instrument: in the Abyssinian tradition it is the drum. If I had continued to give you an account of my trip since I returned from Japan, I could have given an account of the very particular function which in Japanese theatre, in its most characteristic form, that of the No, is played precisely by the

style, the form, of certain types of pulsations in so far as they have, with respect to what we could call the precipitation and the kernel of interest, a really precipitating and binding function. I could also, in referring to the ethnographical field, find myself, as moreover Reik himself does, reminding you of the function of what is called the "bull roarer", namely this instrument which is very close to a kind of top, even though it is constructed very differently, that in the ceremonies of certain Australian tribes, gives rise to a certain type of droning that the name of the instrument compares to nothing other than the bellowing of an ox, the name designates it, and which deserves in effect to be linked in Reik's study to this function of the shofar in so far as it too is made equivalent to what other passages of biblical texts call the roaring, the bellowing of God. The interest of this object is to show us the locus of the voice - and of what voice, we will see its meaning by taking our bearings in its connection in the topography of the relationship of the big Other; let us not go too quickly - but by thus presenting this voice to us in the exemplary form where (10) it is in a certain fashion in potency, in a separated form; because it is what is going to allow us at least to give rise to a certain number of questions which are hardly ever raised.

The function of the shofar enters into action at certain periodic moments which are presented at first sight as the renewals of what? Of the pact, of the Alliance. The shofars do not articulate the basic principles, the commandments of this pact. It is nevertheless quite obviously presented, even down to the dogmatic articulation inscribed, in its connection, in the very name that is current of the moment that it intervenes, as having the function of remembering, Zikor, to remember.

Zikor, to remember, a function supported by three signs. 7103
 which support the function or memory in so far as it appears appropriate here. What I might call the median moment in these three solemn blasts of the shofar, at the end of the days of fasting of Rosh Hashanah, is called Zikron and what is involved, Zikron Terway, designates properly the sort of tremolo which is proper to a certain way of sounding the shofar; let us say that it is the sound of the shofar, the Zikronot, which is the remembrance that is linked to this sound. The remembrance, is no doubt the remembrance of something, of something on which one meditates in the preceding moments, the remembrance of the Hakada.

The Hakada, is the moment of Abraham's sacrifice, the precise one at which God stops his already consenting hand to substitute for the victim, Isaac, the ram that you know about or think you know about. Does that mean nevertheless that this very moment of the pact is entirely included in the sound of the shofar, the memory of the sound of the shofar, the sound of the shofar as sustaining the memory? Is the question not posed of who has to remember? Why think that it is the faithful, since they have just spent a certain time of recollection about this memory?

The question has a very great importance, because it leads us

properly speaking onto the terrain where there was outlined, in the mind of Freud, in the most striking way, the function of repetition. Is the function of repetition only automatic and linked in a way to the return, to the necessary transporting into the battery of the signifier, or has it indeed another dimension which it does not appear inevitable to meet with in our experience, if it has a meaning and the one which gives meaning to this interrogation carried by the definition of the locus of the Other which is characteristic of what I am trying to sustain before you, that to which, in a word, I am trying to accommodate your mental style. Is the one whose memory must be awakened, I mean to ensure that he for his part remembers, not God himself?

Such is the point to which we are brought, I would not say by this very simple instrument, because in truth each one can only experience, before the existence and the function of such an (11) apparatus, at the very least a profound feeling of embarrassment.

But what is involved for us now is to know where it is to be inserted as a separate object, in what domain, not at all in the opposition of inside to outside, whose whole inadequacy you sense clearly in this case, but with reference to the Other, in the stages of the emergence, of the progressive establishment of the subject, with reference to this enigmatic field which is the Other, at what moment can there intervene such a type of object with its face finally unveiled in its separable form and which is now called something that we know well, the voice, which we know well, which we believe we know well in its waste scraps, the dead leaves, in the form of voices, the stray voices of psychosis, and its parasitic character in the form of the interrupted imperatives of the super-ego. It is here that we must in order to orientate ourselves, to map out the true place, the difference of this new object which rightly or wrongly for reasons of presentation I thought I should tackle for you today, present under a form that is somehow manageable, if not exemplary, it is here now that we have to map out, to see the difference, the newness it introduces compared to the previously articulated stage, the one which concerned the structure of desire in another exemplary form - but as you cannot but sense, a very different one - and regarding which it seems that everything which is revealed in this new dimension can only be, and cannot but be, at first masked in this other previous stage, that we must for a moment return to it to make better emerge, stand out from the new thing that is contributed by the level at which there appears the form of o which is called the voice.

Let us return to the level of the eye which is also that of space, not the space that we question in the shape of a fixed transcendental aesthetic, even though undoubtedly the reference to what Kant contributed in this terrain is very useful to us, or as least very handy, but in what space presents for us as characteristic in its relationship to desire.

The origin, the basis, the structure of the function of desire as such is, in a style, in a form each time to be specified, this

central object o in so far as it is not alone separated, but elided, always elsewhere than where desire supports it and nevertheless in a profound relationship with it. This character of elision is nowhere more manifest than at the level of the function of the eye. And this is why the most satisfying support of the function of desire, the phantasy, is always marked by a relationship with the visual models in which it functions commonly, as one might say, in which it gives the tone of our desiring life.

In space nevertheless - and it is in this "nevertheless" that (12) there belongs the whole import of the remark - apparently nothing is separated. Space is always homogeneous, when we think in terms of the space of this body, our own, from which its function emerges. It is not idealism, it is not at all because space is a function of the mind that it cannot justify any kind of Berkeleyanism; space is not an idea, space is something which has a certain relationship not with the mind but with the eye.

Even this body has a function. What one? This body is appended. Once we think about space, we must in a way neutralise it by localising it there. Think simply of the way in which the physicist mentions on the blackboard the function of a body in space. A body is anything whatsoever and it is nothing; it is a point, it is something which all the same must be localised there by something foreign to the dimensions of space, except by producing there insoluble questions about the problem of individuation, in connection with which you have already heard on more than one occasion, I think, the manifestation, the expression of my derision.

A body in space, is simply something which at the very least is presented as impenetrable; there is a certain realism about space that is completely untenable and - as you know because I am not going to spell out its antinomies for you here - necessary. The very usage of the function of space, however punctual you may suppose it to be, supposes an indivisible unity, at once necessary and unsustainable, which is called the atom, completely impossible of course to identify with what is described in physics by this term which, as you know, has nothing atomic about it, I mean that it is in no way indivisible.

Space is of no interest unless there is supposed this final resistance to division, because it has no real usage unless it is discontinuous, namely if the unit which operates there cannot be in two points at the same time.

What does that mean for us? It is that this spatial unit, the point, can only be recognised as inalienable, which means for us that it cannot in any case be o.

What does what I am in the process of telling you mean? I press forward to make you fall again into the nets of what you have already heard. This means that through the form $i(o)$, my image, my presence in the Other is without a remainder. I cannot see what I am losing there. This is the meaning of the mirror stage

and the meaning of this schema that was forged for you, whose place you now see exactly, since it is the schema destined to ground the function of the ideal ego/ego-ideal in the fashion in which the relationship of the subject to the Other functions, when the specular relationship, called in this case the mirror of the big Other, dominates it.

(13) This image $i(o)$, the specular image, the characteristic object of the mirror stage, has more than one seduction which is not simply linked to the structure of each subject, but also to the function of knowledge. It is complete, I mean closed, it is Gestalt-like, namely marked by the predominance of the good shape, and is also intended to put us on our guard against this function of the Gestalt, in so far as it is founded on the experience of the good shape, an experience precisely that is characteristic of this field. For to reveal the degree of "appearance" in this satisfying character of the form as such, indeed of the idea of its rootedness in the visual eidos, to see and tear apart what is illusory in it, it is enough to make a stain on it: to see where this point of desire is really attached, to perform "the function", if you will allow me the equivocal usage of a current term to support what I want to get you to hear, a stain is enough to perform the "function" of beauty spot (grain de beauté).

The spots and outcomes - you will allow me here to continue the equivocation - of beauty show the place of o , here reduced to this zero point whose function I evoked the last time. The beauty spot, more than the shape that it stains, is what looks at me. And it is because it looks at me that it draws me so paradoxically, sometimes more - and with more right - than the look of my partner; for this look reflects me after all and in so far as it reflects me, it is only my reflection, an imaginary buoy. There is no need for the crystalline lens to be thickened by a cataract to blind vision, to blind it in any case to the following: the elision of castration at the level of desire in so far as it is projected into the image.

The blankness of the eye of the blind man, or to take another image in this moment, which I hope you remember, even though it is an echo of another year, the jet-setters of La dolce vita, at the final phantastical moments of the film when they advance as it were jumping from one shadow to another of the pine wood through which they make their way to get to the beach, they see the inert eye of the marine creature that the fishermen are in the process of dragging ashore, it is by this that we are most looked at, and it shows how anxiety emerges in the vision of the locus of desire that it determines.

This is the virtue of tattooing, and I do not need to recall for you this admirable passage of Levi-Strauss, when he evokes the outbreak of desire of the parched colonisers when they get to this zone of Parana where there await them these women entirely covered with shimmering overlapping drawings in the greatest variety of shapes and of colours.

At the other end, what I would evoke, is that, as I might say, in referring to the emergence which, as you know, is more marked (14) for me by creationist rather than evolutionist style of forms, the appearance of the visual apparatus itself, at the level of the fringes of the lamellibranchiata, begins with a pigmentary stain, the first appearance of a differentiated organ in the sense of a sensibility which is already properly speaking visual. And of course there is nothing more blind than a stain! To the spot (mouche) mentioned earlier, I would add the spots before the eyes (mouche volante) which give the first warning of organic danger to people in their fifties.

Zero of o, it is through this that visual desire masks the anxiety of what is essentially lacking to desire, of what determines us when all is said and done, if we remain with this field of vision, to grasp only, to be ever only able to grasp any living being as what he is in the field of the pure visual signal, what ethology calls a dummy, a puppet, an appearance.

o, what is lacking, is non-specular, it is not graspable in the image. I highlighted for you the blank eye of the blind man as being at once the revealed and the irremediably hidden image of scopophilic desire. The eye of the voyeur itself appears to the other as what it is: as impotent. This indeed is what allows our civilisation to put in a box what supports it in different forms that are perfectly homogeneous with the dividends and the bank reserves that it determines.

This relationship of desire to anxiety in this radically masked form, linked by that very fact to the structure, of desire in its most deceptive functions, dimensions, is the specifically defined stage to which we have now to oppose how much openness is brought to it by the other function, that which I introduced today with this accessory, which is not nevertheless accidental, of the shofar.

Do I need, in closing my discourse, to anticipate on what I will articulate step by step the next time, namely how our most elementary tradition, that of Freud's first steps, commands us to distinguish this other dimension. What does it tell us? Here again I would pay homage to my friend Stein for having articulated it very well in his discourse: if desire, he says - and I subscribe to his formula, because I find it more than brilliant - if desire were primordial, if it were the desire of the mother which determined the bringing into the play of the original crime, we would be in the field of vaudeville. The origin, Freud tells us in the most formal fashion - and by forgetting it the whole chain is undone and it is because of not having secured this beginning of the chain that analysis, I am speaking about analysis in theory as in practice, seems to undergo this form of dispersion where one can ask oneself on certain occasions whether there is anything that can still preserve its coherence - it is because the murder of the father and everything that it determines is what reverberates - if one is to understand what one hopes is only a metaphor in Reik's mouth - as the bellowing of a felled bull which still makes

itself heard in the sound of the shofar, let us say more simply that it is from the original fact inscribed in the myth of murder as the starting point of something whose function we have henceforth to grasp in the economy of desire, it is starting from that as a prohibition impossible to transgress that there is constituted in the most fundamental form the original desire.

It is secondary with respect to a dimension that we have to tackle here with respect to the essential object which functions as o, this function of the voice and what it contributes in terms of new dimensions in the relationship of desire to anxiety. This is the detour through which the functions of desire, object, anxiety are going to regain their value at every stage, right up to the stage of the origin. And in order not to fail to anticipate your questions and to tell you also perhaps, to tell those who have posed them, that I am not forgetting this field and the furrows that I have to trace in it in order to be complete, you may have noticed that I have not given an account either of the anal object or of the anal stage, at least since we have taken up our talks again: it is as a matter because it is properly speaking impossible if it is not within the context of a total reworking of the function of desire, starting from this point which because it was enounced here the last time is the most original, the one that I will take up the next time around the object of the voice.

Seminar 20: Wednesday 29 May 1963

On reading, these days, some works which have recently appeared about the relationships of language to thought, I was led to re-present for myself what after all I can indeed at every moment put in question for myself, namely the place and the nature of the angle from which I am trying to attack something, which in any case can only be, - without that what would I have to tell you - an inevitable, necessary limit to your understanding. This does not present any particular difficulty, in its objective principle, all progress of a science depending as much and more on the phasic handling of its concepts as on the extension of its grasp, which may give rise here - I mean in the psychoanalytic field - to an obstacle which deserves particular reflection; it is not as easily soluble as the passage from one conceptual system to another, for example from the Copernican system to the Einsteinian system. For after all one may suppose that for sufficiently well developed minds, that does not create a difficulty for very long. For minds sufficiently open to mathematics, it does not take too long for it to become clear that the Einsteinian equations hold up, are included in the ones which preceded them, that it situates them as particular cases, therefore completely resolves them.

That does not mean that there may not be, as the experience of history proves, a moment of resistance, but it is short. In the whole measure that, as analysts - I mean in the whole measure of our implication, whether it is more or less: to interest oneself a little in psychoanalysis is already to be a little implicated in it - in the whole measure of our implication in psychoanalytic technique, we have to encounter in the development of concepts the same obstacle designated, recognised, as constituting the limits of analytic experience, namely castration anxiety.

It **is** as if what reaches me from different distances from where I am speaking - and not necessarily always to respond to what I am saying, but certainly in a certain zone of response - it is as **if** at certain moments a hardening takes place in certain technical (2) positions, strictly correlative in this matter to what I can call the limits of understanding; it is also as if to overcome these limits I had chosen a path that is perfectly defined, at the level of school-going age, by a pedagogical school that poses in a certain fashion the problems of the relationship between teaching in school and the maturation of the thinking of the child, it is as if I were adhering - and I adhere in effect, if

one looks closely at this pedagogical debate - to this style of pedagogical procedure which is far, believe me, you can check it out, there are some of you who are closer to it than others, more required to be interested in these pedagogical procedures, you will see that the schools are far from being in agreement on the procedure that I am now going to articulate and define. For one school, if you wish, put it wherever you like, for the moment on my left, that means nothing more, everything is determined by an autonomous maturation of intelligence, all one does is follow it, I mean at school-going age; for the others there is a fault, a gap. The first, let us designate it for example by the theories of Stern - I did not say it immediately because I think that a good number of you have never opened the works of this psychologist who is nevertheless universally recognised - for the others, let us say, take Piaget, there is a gap, a fault between what childish thinking is capable of forming and what can be brought to it along these scientific paths. It is clear, if you look carefully at it, it means in both cases reducing the efficaciousness of teaching as such to zero.

Teaching exists: what makes numerous spirits in the scientific arena able to overlook it, is that effectively, in the scientific field, once one has reached it, what is properly of the order of teaching, in the sense that I am going to specify it, can be, in effect, considered elidible, namely that, when one has broken through a certain stage of mathematical understanding, once it is done, it is done; one no longer needs to search out its paths. One can, as I might say, reach it without any difficulty provided one belongs to the generation to whom these things were taught in this form, in this formalisation, as a primary intention.

Extremely complicated concepts, or more exactly ones which (3) appeared at an earlier stage of mathematics to be extremely complicated, are immediately accessible to very young minds. It is certain that one needs no intermediary when one is of school-going age and that the whole interest of school pedagogy depends on grasping, on ascertaining this central point or to anticipate, by problems which go slightly beyond them, what are called the mental capacities of the child. And by helping him - I am saying: simply by helping him - to tackle these problems, one does something which has an effect, not simply pre-maturing the effect of haste on maturation, but an effect which in certain periods that one can call - they have been called that - "sensitive" - those who know a little about this subject can see where; I continue, because the important thing is my discourse, and not my references - one can obtain veritable effects of unleashing, of opening out of certain apprehensive activities in certain domains, effects of a quite special fecundity.

It is exactly what seems to me can be obtained in the domain that we are advancing into together here in so far as, because of the specificity of its field, there is always involved in it something which it would be well for pedagogues to map out one day. There have already been beginnings in the works of authors whose testimony is all the more interesting to retain in that they have no notion of what their experience may contribute to

us: the fact that one pedagogue was able to formulate that there is real access to the concept only from the age of puberty on - I mean experimenters who know nothing about, who do not want to recognise anything about analysis - is something which would merit our taking our own look at it, sticking our nose into it, grasping - in the place where I am speaking to you, there are a thousand tangible traces - that it is properly speaking in function of a link which can be made about the maturation of the object o as such, namely as I define it, at this age of puberty that one can conceive of a quite different mapping out than the one which is made by these authors of what they call "the limit moment" when there is truly the functioning of the concept, and not this sort of use of language that they call in this case, not conceptual, but "complexual", by a sort of homonymy which is a pure encounter with the term "complex" that we use.

(4) This position of o at the moment of its passage, through what I symbolise with the formula of $(-\langle p)$ is one of the goals of our explanations this year. It cannot be valorised, taken up by your ears, it cannot be validly transmitted, except by some approach, which can here only be a detour, to what constitutes this moment characterised by the notation $(-\langle P)$, and which is and can only be castration anxiety.

It is because this anxiety here cannot in any way be made present as such, but only mapped out by this sort of concentric path which makes me, as you see, oscillate between the oral stage and something which I said the last time was supported by the evocation, in a separated form, materialised in an object which is the voice, of this shofar - you will allow me today to take it up and to put it aside in a moment - that we can now return to the central point that I evoke in speaking about castration. What really is this relationship between anxiety and castration? It is not enough for us to know that it is experienced as such, at one or other phase of analysis which is described as terminal or non-terminal, for us to really know what it is.

To say things immediately as they are going to be articulated at the next step, I would say that the function of the phallus as imaginary, functions everywhere at every level, high up and low down, that I defined, characterised by a certain relationship of the subject to o , the phallus functions everywhere, except where one expects it, as a mediating function, specifically at the phallic stage, and it is this lack as such of the phallus which is present, detectable, often to our great surprise everywhere else, it is this vanishing of the phallic function as such, at this level where it is expected to function, which is the principle of this castration anxiety.

Hence the notation $(-\langle p)$ denoting what I might call this positive absence, and since this was never formulated in such a manner in this form, no place was allowed either for its consequences to be drawn.

To make tangible the truth of this formula, I will take different paths in accordance with the mode which I described earlier as

(5) that of turning around. And since the last time I recalled to you the proper structure of the visual field concerning what I called both the sustentation and the occultation in this field of the object *o*, I cannot do less than return to it when, in a fashion that we know to be traumatic, it is in this field that there is presented the first approach to the phallic presence, namely what is called the primal scene.

Everyone knows that despite the fact that it is present, visible in the shape of a functioning of the penis, that what is striking in the evocation of the reality of the phantasised form of the primal scene, is always some ambiguity concerning precisely this presence.

How often can one say precisely that it is not seen at its place, and even sometimes that the essential of the traumatic effect of the scene is precisely the forms under which it disappears, is conjured away.

Moreover I would only have to evoke, in its exemplary form, the mode of apparition - where in any case, for our purposes, we should not deceive ourselves, the anxiety which accompanies it sufficiently signals that we are indeed on the path that we are seeking - the mode of apparition of this primal scene in the story of the Wolfman. We have heard it said somewhere that there was something obsessional, it appears, in the fact that we return here I do not think every time that I am in your presence, but in the fact that we return to these original examples of the Freudian discovery; these examples are more than the supports, more even than the metaphors, they make us put our finger on the very substance of what we have to deal with.

The essential in the revelation of what appears to the Wolfman through the gap which prefigures in a way what I made into a function, that of the open window, that which appears in its frame identifiable in its form to the very function of phantasy in its most anxiety-provoking mode, it is manifest that the essential in it is not to know where the phallus is; it is there, as I might say, identical everywhere to what I could call the "catatonia of the image": the tree, the wolves perched on it who - you can find in this the echo of what I articulated for you the last time - look fixedly at the subject, there is no need to search in this fur, repeated five times, in the tail of the five animals, for what is involved and which is there - as I told you - in the very reflection that the image supports of a catatonia which is nothing other than that of the subject himself, of the child petrified, fascinated by what he sees, paralysed by this fascination to the point that what is looking at him in the scene and which is in a way everywhere invisible, we can indeed conceive of as an image which here is nothing other than the transposition of his arrested state, of his own body transformed here into this tree, that we might describe as, to echo a celebrated title, "the tree covered with wolves, l'arbre couvert de loups".

That what is involved is something that echoes this experiential

pole that we have defined as that of jouissance, appears to me to be unquestionable. This sort of jouissance, akin to what moreover Freud calls the horror of the jouissance the Ratman is unaware of, a jouissance going beyond any possible mapping out by the subject, is here presentified in this erect form, the subject is no longer anything but erection in this grip which makes of him a phallus, makes a tree of him, horrifies him (l'arborifie, l'arb-horrifie), which completely immobilises him.

Something happens which Freud testifies to us as only having been reconstructed on this occasion: essential though it may be, the symptomatic development of the effects of this scene is so essential that the analysis Freud gives of it could not even be put forward for a moment, if we do not admit this element which remains the only one not integrated up to the end by the subject and presentifying on this occasion what Freud articulated later about reconstruction as such: it is the response of the subject to the traumatic scene by a defecation. The first time, or the quasi-first time, the first time in any case that Freud has to note in a particular fashion this function of the appearance of the excremental object at a critical moment, note - consult the text - that in a thousand forms he articulates it as a function to which we can give no other name than the one that it was thought necessary to articulate later as characteristic of the genital stage, namely as a function of oblativity. It is a gift, he tells us. Moreover everyone knows that Freud underlined from the first the character of gift on all the occasions that you will allow me to call in passing and with no further commentary, (7) if you remember my reference points, the cases of passage a. l'acte in which the little child inopportunately releases some of his intestinal contents.

And in the text of the Wolfman things go even further, giving its true sense, the one that we have drowned under a wave of moralising assumptions about oblativity, Freud speaks in this connection about sacrifice, something which - you will admit - given Freud's reading - for example, we know that he had read for example, Robertson Smith - that, when he spoke about sacrifice, he was not speaking about something up in the air, a kind of vague moral analogy, Freud speaks about sacrifice in connection with the apparition of this excremental object in the field. After all that must mean something.

It is here that we will take up the thing at the level, if you wish, of the normal act, of the act rightly or wrongly qualified as mature, that at the level of which I thought I could in my seminar before last, if I remember rightly, articulate orgasm as being the equivalent of anxiety and situating itself in the inner field of the subject, while I provisionally left castration with this single mark. It is quite obvious that one could not detach from it the sign of the intervention of the other as such; this characteristic in reality having always been, from the beginning, attributed to it, it is therefore the other who threatens castration.

I pointed out in this connection that by assimilating, by making

equivalent orgasm as such and anxiety, I was taking up the position which rejoined what I had previously said about anxiety as a reference, a signal of the only relationship which does not deceive, that we could find in it the reason for what could be satisfying in orgasm. It is from something that happens in the perspective in which it is confirmed that anxiety is not without an object, that we can understand the function of orgasm and more especially what I called "the satisfaction that it carries with it".

I believed at that time that I could not say any more if I was to be understood. It nevertheless remains that an echo has come to me, let us say to put it mildly, of some perplexity in the terms that were interchanged, if this echo is correct, precisely in the case of two people that I believed I had formed particularly well. It is all the more surprising that they could interrogate themselves in this case about what I meant by this satisfaction.

(8) Is what is involved then, they asked one another, jouissance? Is it a way of returning in a certain fashion to this derisory absolute that certain people want to put into genital fusion, so called? And then, since it was a matter of seeing the relationship between this anxiety point - put into this point all the ambiguity that you wish - a point where there is no longer anxiety if the orgasm covers it over, and this point of desire in so far as it is marked by the absence of the object o in the form of $(-P)$, what happens, they asked themselves to this relationship in the case of the woman? Answer: I did not say that the satisfaction of orgasm was identified with what I defined in the seminar on Ethics about the locus of jouissance. Answer - it even appears ironic to underline it-: the little satisfaction, even if it is sufficient, brought by orgasm, why should it be the same and at the same point as this other little which is offered to a woman even in a successful copulation? This is what should be articulated in the most precise fashion. It is not enough to say vaguely that the satisfaction of orgasm is comparable to what I call elsewhere, on the oral plane, the crushing of demand under the satisfaction of need. At this oral level, the distinction between need and demand is easy to sustain, and besides does not fail to pose us the problem of where the drive is situated. If by some artifice one can equivocate at the oral level about what is original in the grounding of demand in what we analysts call drive, this is what we do not in any case have any right to do at the genital level. And precisely there where it would seem that we are dealing with the most primitive instinct, the sexual instinct, it is there less than anywhere else that we cannot fail to refer to the structure of the drive as being supported by the formula $\$ \llcorner D: \$$ relationship of desire to demand.

What is demanded at the genital level and from whom? That effectively the experience which is so common, fundamental that it ends up in its obviousness by no longer noticing its relief, effectively interhuman copulation with the transcendence it has compared to individual existence - we needed the detour of a rather advanced biology to be able to notice the strict

(9) correlation between the appearance of bisexuality and the

emergence of the function of individual death, but after all people always had a presentiment that in this act where there is bound closely, then, what we ought to call the survival of the species conjoined with something which cannot fail, if the words have a meaning, to involve what we have located at the final term as the death drive, after all why should we refuse to see what is immediately tangible in facts that we know quite well, which are signified in the most common usages of the tongue - we demand - I have not yet said from whom, but after all since it is necessary always to demand something from someone, it happens that it is from our partner, is it quite sure that it is from her, we will have to see in a second phase - but what we demand is what? It is to satisfy a demand which has a certain relationship with death. What we demand does not go very far: it is the little death (la petit mort); but after all it is clear that we demanded it. That the drive is intimately mingled with this drive of the demand, that we demand to make love (l'amour), if you wish to make "l'amourir", it is to die (mourir), it is even to die laughing (de rire)² It is not for nothing that I underline that which in love participates in what I call the comic feeling. In any case it is indeed here that there ought to reside post-orgasmic relaxation. If what is satisfied is this demand, well then God knows, it is to be really satisfied, one gets out of it!

The advantage of this conception is to make appear, to give the reason, why anxiety appears in a certain number of ways of obtaining orgasm. In the whole measure that orgasm is detached from this field of the demand of the other - it is the first apprehension that Freud had of it in coitus interruptus - anxiety appears, as one might say, in this margin of the loss of signification. But as such, it continues to designate what is aimed at in terms of a certain relationship to the other. I am precisely not in the process of saying that castration anxiety is an anxiety about death; it is an anxiety which refers to the field where death is closely bound up with the renewal of life, it is an anxiety which, if we localise it at this point, allows us to understand very well why it is equivalently interpretable as the reason why it is given to us, in Freud's final conception, as the signal of a threat to the status of the defended "I". It refers to a beyond of this defended "I", at this point of appeal (10) for a jouissance which goes beyond our limits, in so far as here the other is properly speaking evoked in this register of the real which is how a certain type, a certain form of life is transmitted and is sustained. Call that whatever you wish, God or the genius of the species. I think that I have already sufficiently implied in my discourse that this does not carry us towards any metaphysical heights. What is involved here is a real, this something which maintains what Freud articulated at the level of his Nirvana principle as being this property of life, of having, in order to reach death, to repass by forms which reproduce the ones which had given to the individual form the occasion of appearing through the conjunction of two sexual cells.

What does that mean? What does that mean as regards what happens

at the level of the object? What does it mean, if not that in short this result, that I called such a successful result, is only realised in such a satisfactory fashion in the course of a certain automatic cycle that remains to be defined and because precisely of the fact that the organ is never able to hold up very long on the path of the appeal for jouissance. With regard to this end of jouissance and to reaching this appeal of the other in a term which would be tragic, the amboceptor organ can always be said to give way prematurely.

At the moment, I might say, that it could be the sacrificial object, well then, let us say in the ordinary case it has long disappeared from the scene. It is no longer anything but a little rag, it is no longer there except as a testimony, as a memory for the partner in tenderness. In the castration complex, this is what is involved, in other words this only becomes a drama in so far as there is raised, pushed in a certain direction - one which places all its trust in genital consummation - the putting in question of desire.

If we let go of this ideal of genital achievement, by seeing what is structurally, happily alluring in it, there is no reason why the anxiety linked to castration should not appear to us in a much more supple correlation with its symbolic object, and with an opening out that is quite different to the objects of other levels, as this moreover has always been implied by the premises (11) of Freudian theory, which put desire in a completely different relationship to a purely and simply natural one to the natural partner as regards its structuring.

I would like, to make you better sense what is at stake, to recall all the same what is involved in what one might say are, at first, savage relationships between man and woman. After all, a woman who does not know whom she is dealing with, it is indeed, in accordance with what I put forward to you about the relationship between anxiety and the desire of the Other, because she is not before the man without a certain unease about where exactly this path of desire is going to lead her. When the man, by God, makes love like everyone else and is disarmed, if the woman - something which as you know is very conceivable - does not draw, I would say, any obvious profit from it, there is in every case something that she has gained, it is that she is henceforth altogether at ease about the intentions of her partner.

In the same chapter of The Wasteland, by T S Elliot, to which I referred on a particular day when I thought it well to confront with our experience the old theory about the superiority of woman on the plane of jouissance, the one in which T S Elliot allows Tiresias to speak, we find these verses - whose irony made it always seem to me that they ought one day to have their place here in our discourse - when the carbuncular young dandy, the little clerk from the building society, has finished with the typist whose surroundings are all along depicted for us, has finished his little affair, T S Elliot expresses himself as follows:

"When lovely woman stoops to folly and
Paces about her room again, alone,
She smooths her hair with automatic hand,
And puts a record on the gramophone."

What is meant by: "When lovely woman stoops to folly", is not to be translated, it is a song from the Vicar of Wakefield, when a beautiful woman abandons herself to folly - "stoops" is not the same thing as "s'abandonne" - lowers herself to folly, and then finally finds herself alone, she strides across the room stroking her hair automatically with her hand, and changes the record.

This by way of response to the question my pupils were posing amongst themselves about what is involved in the question of the desire of the woman. The desire of the woman is determined by (12) the question, for her also, of her jouissance. The fact that she is not simply much closer than man to jouissance, but doubly determined by it, is something that analytic theory has always taught us. That the locus of this jouissance is linked for us to the enigmatic, unsituatable character of her orgasm, is something that our analyses have been able to take far enough for us to be able to say that this locus is a rather archaic point since it is older than the present separation of the cloaca, something that was perfectly well located from a certain analytic perspective by a particular analyst of the female sex.

That desire, which is not at all jouissance, is in her case naturally where it ought to be according to nature, tubular (tubaire) ■ is something that the desire of those we call hysterics designates perfectly. The fact that we should have classified these subjects as hysterics changes nothing in the fact that desire thus situated is true, is organically true.

It is because man will never carry the point of his desire to that extreme, that one can say that the jouissance of the man and of the woman are not organically conjoined. It is indeed in the measure of the failure of the desire of man that the woman is led, as I might say, normally to the idea of having the man's organ, in so far as it is supposed to be a veritable amboceptor: this is what is called the phallus. It is because the phallus does not realise, except in its evanescence, the meeting of desires, that it becomes the common locus of anxiety.

What the woman demands from us analysts, at the end of an analysis conducted in accordance with Freud, is no doubt the penis, Penisneid, but in order to do better than the man. There is something, there are many things, there are a thousand things which confirm all of that. Without analysis what is there for the woman as a way of overcoming this Penisneid, if we suppose it to be always implicit; we know it very well, it is the most ordinary mode of seduction between the sexes, it is to offer to the desire of man the object involved in phallic claims, the non-detumescent object to sustain his desire, it is to make of her feminine attributes the signs of the omnipotence of man. And (13) it is this that - I would ask you to refer to my old seminars - this is what I thought it worth while valorising by

underlining, after Joan Riviere, the correct function of what she calls "Womanliness as masquerade". She has simply to forget about her jouissance.

In the measure that we leave her in a way on this path, we find ourselves signing the decree of the renewal of the phallic claim, which becomes, I would not say the compensation, but as it were the hostage of what one demands from her in fact for taking charge of the failure of the other.

Such are the paths on which there are presented, in considering the genital plane, genital realisation as a term, what we could call the impasses of desire, if there were not the opening up of anxiety. We will see, restarting from the point that today I have led you to, how the whole analytic experience shows us that it is in the measure that it is summoned as object of propitiation in a failed conjunction, that the phallus which proves to be missing, constitutes castration itself as a point that it is impossible to get round in the relationships of the subject to the Other, and as a point that has been resolved as regards its anxiety function.

Seminar 21: Wednesday 5 June 1963

What I told you the last time ended, I believe, significantly with the silence which greeted my remarks, no one it seems having preserved enough sangfroid to reward them with a little applause. Either I am wrong or perhaps after all it is not too much to see in this the result of what I had expressly announced in beginning these remarks, namely that it was not possible to tackle castration anxiety head on without provoking, let us say, some echo of it. And after all this is not an excessive pretension, since what I told you is, if fact, something that could be qualified as not very encouraging, because it concerned the union between man and woman, an ever-present problem all the same, and one that quite correctly always has, and I hope that it still finds, a place in the preoccupations of psychoanalysts.

Jones circled for a long time around this problem materialised, incarnated by what is supposed to be implied in the phallo-centric perspective of primal ignorance, not only of man, but of woman herself, about the locus of conjunction, the vagina. And all the partly fruitful, even though incomplete detours that Jones went into on this path, show very well their aim in what he invokes - as I recalled for you at one stage - the famous "Man and woman he created them" which moreover is so ambiguous. For after all - one is entitled to say - Jones did not meditate on the Hebrew text of this verse 27 of Book 1 of Genesis.

In any case, to try to support what I said the last time on my little schema constructed by using these Euler circles, this could be supported as follows: the field opened up by man and woman in what one could call, in the biblical sense, their knowledge of one another, only intersects because the zone in which they could effectively overlap, where their desires carry them to reach one another, is qualified by the lack of that which would be their middle term, the phallus. For each of them, it is that which, when it is attained, alienates it precisely from the other.

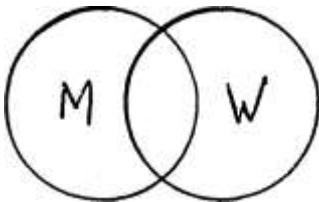

The woman can undoubtedly be the symbol of the man, in his desire for phallic omnipotence, and precisely in so far as she is no longer the woman. As regards the woman, it is quite clear through all that we have discovered, what we have called Penisneid, that she can only take the phallus for what it is not,

(2) namely either o the object, or her own too small (jp) , which only gives her a jouissance approximating to what she imagines is the jouissance of the other, which she can no doubt share through a sort of mental phantasy, but only by straying from her own jouissance.

In other words, she can only enjoy (&) because it is not at its place, at the place of her jouissance, where her jouissance can be realised. I am going to give you a little illustration of it that is a little controversial, somewhat marginal, but contemporary. In an audience like this, how often, do we analysts, how often, to the point that it becomes something constant in our practice, do women want to be analysed like their husbands, and often by the same psychoanalyst? What does that mean, if not that the supposedly rewarded desire of their husband which they have the ambition to share, the - **(-P)** the re-positiving of (<p) that they suppose operates in the analytic field, this is what they have the ambition to attain.

That the phallus is not found where it is expected, where it is required, namely on the plane of genital mediation, is what explains that anxiety is the truth of sexuality, namely what appears every time its flow retreats, runs into the sand. Castration is the price of this structure, it substitutes itself for this cruth. But in truth, this is an illusory game; there is no castration because, at the place where it has to happen, there is no object to castrate. For that, it would be necessary for the phallus to be there. But it is only there so that there will be no anxiety.

The phallus, where it is expected as sexual, never appears except as lack, and this is its link with anxiety. And all of this means that the phallus is called on to function as an instrument of potency. Now potency, I mean what we are speaking about when we speak about potency, when we speak about it in a fashion which vacillates about what is involved - for it is always to omnipotence that we refer ourselves; now that is not what is involved, omnipotence is already the slippage, the evasion with respect to this point at which all potency fails - one does not demand potency to be everywhere, one demands it to be where it is present. It is precisely, because it fails where it is expected, (3) that we begin to foment omnipotence. In other words: the phallus is present, it is present everywhere it is not up to it.

For it is the aspect which allows us to pierce this illusion of the claim engendered by castration, in so far as it covers the anxiety presentified by every actualisation of jouissance; it is this confusion between jouissance and the instruments of potency. Human impotence, with the progress of institutions, becomes better than this state of fundamental misery where it constitutes itself into a profession, I mean a profession in every sense of the word, from the sense of the profession of faith, up to the term, to the aim that we find in the professional ideal.

Everything that shelters behind the dignity of any profession, is

always this central lack which is impotence. Impotence, as one might say, in its most general formula, is what destined man to be only able to orgasm (jouir) from his relationship to the support of (+<p), namely from a deceptive potency. If I remind you that this structure holds up after what I articulated the last time, it is to lead you towards some remarkable facts which control the structure articulated in this way; the famous term homosexuality, which in our doctrine, our theory, the Freudian one, is seen as the principle of social bonding, let us note that Freud always remarked, never raised a doubt on the point, that it is the privilege of the male. This libidinal cement of the social bond, in so far as it is only produced in the community of males, is linked to the aspect of sexual failure which is imparted to it very specially because of the fact of castration.

On the contrary female homosexuality has perhaps a great cultural importance, but no value as a social function, because it is brought to bear, for its part, on the proper field of sexual rivalry, namely there where in appearance it would have the least chance of succeeding, were it not for the fact that precisely in this field those who are at an advantage, are precisely those who do not have the phallus, namely that omnipotence, the greatest liveliness of desire is produced at the level of this love which is called Uranian, which I believe has marked by its bonding the most radical affinity to what one can call female homosexuality.

An idealistic love, the presentification of the essential mediation of the phallus as (-£>). This (jP) therefore, for both sexes, is what I desire and what I can only have qua (-jp). It is (4) this minus which is found, in the field of sexual conjunction, to be the universal third term, to be this ego, my dear Reboul, which is not at all the reciprocal Hegelian one, but in so far as it constitutes the field of the Other as lack, I only accede to in so far as I take this very path, that I attach myself to the fact that this "I" makes me disappear, that I only rediscover myself in what Hegel perceived of course, but which he justifies without this interval, only in a generalised o, only in this idea of the ego in so far as it is everywhere, namely in so far as it is nowhere. The support of desire is not designed for sexual union; for generalised, it does not specify me more as a man or a woman, but as one or the other. The function of this field described here as that of sexual union, poses for each of the two sexes the alternative: the other is either the other or the phallus in the sense of exclusion. This field here is empty, but this field here, if I make it positive, the "or" takes on this other meaning which means that one is substitutable for the other at every moment.

This is the reason why it was not by chance that I introduced the field of the eye hidden behind every spatial universe, with a reference to these beings-images on the encounter with whom there is played out a certain path of salvation, specifically the Buddhist path, by introducing the one that I designated for you as Kuan Yin or in other words Avalokitesvara with its complete sexual ambiguity. The more the Avalokitecvara is presentified as male, the more it takes on female aspects. I will show you, if

that amuses you, some other day the images of Tibetan paintings or statues, there is a superabundance of them and the trait that I designated for you is absolutely obvious here. What is at stake today is to grasp how this alternative between desire and jouissance can find its way. The difference between dialectical thinking and our experience, is that we do not believe in the synthesis. If there is a way through where the antinomy is closed off, it is because it was already there before the constitution of the antinomy.

For the object *o*, in which the impasse of the access from desire to the thing is incarnated, to give him passage, it is necessary to return to the beginning; there is nothing which prepares this passage before the capture of desire in specular space, there is no way out. For let us not omit to say that the possibility of this very impasse is linked to a moment which anticipates and conditions what has come to be marked in the sexual failure of man. It is the bringing into play of the specular tension which eroticises so precociously and so profoundly the field of insight.

(5) What is outlined in the anthropoid about the conductive character of this field has been known since Kohler; that he is not without intelligence, because he can do a lot of things provided he can see what he has to reach.

I alluded last night to the fact that this is the whole point, it is not that the primate is any more incapable of speaking than ourselves, but he cannot make his word enter into this operational field. But that is not the only difference. The difference, marked by the fact that for the animal there is no mirror stage, is what has gone under the name of narcissism, from a certain ubiquitous subtraction of libido, from an injection of the libido into the field of insight, of which specularised vision gives the form. But this form hides from us the phenomenon of the occultation of the eye, which henceforth ought to look from everywhere at the one that we are, with the universality of sight.

We know that this can happen and it is what is called the Unheimlich, but very particular circumstances are necessary. Usually, what is satisfying precisely in the specular form is the masking of the possibility of this apparition. In other words, the eye establishes the fundamental relationship of the desirable in the fact that it always tends to make it miscognised, in the relationship to the other, that under this desirable there is a desirer.

Let us reflect a little on the import of this formula which I believe I can give as being the most general one of what constitutes the arousal of the Unheimlich. Imagine that you are dealing with the most relaxing of desirable things, in its most pacifying form, the divine statue which is only divine. What would be more Unheimlich than to see it coming to life, namely to see it showing itself as desiring!

Now, not alone is it the structuring hypothesis that we pose for the genesis of o that it is born elsewhere and before this, before this capture which hides it, it is not simply this hypothesis, itself founded on our praxis, it is of course from this that I introduce it: (1) either our praxis is faulty, I mean faulty with respect to itself; or (2) it supposes that our field, which is that of desire, is engendered from this relationship of S to O which is the one in which we cannot rediscover what is our goal except in the measure that we reproduce its terms. Either our praxis is faulty with respect to itself or it presupposes (6) this. What our praxis engenders, if you wish, is this universe here, symbolised here in the final term in the famous division which has been guiding us for some time through the three phases in which the subject S that is still unknown has to constitute himself in the Other, and in which the o appears as the remainder of this operation.

I would point out to you in passing that the alternative: either our praxis is faulty or it presupposes this, is not an exclusive alternative. Our praxis can allow itself to be faulty in part with respect to itself, and that there should be a residue since precisely this is what is predicted.

A big presumption that we risk very little by engaging ourselves in a formalisation which is imposed as also being necessary* But this relationship of S to O , must indeed be situated as going far beyond in its complexity, which is nevertheless so simple, inaugural, what those who bequeathed to us the definition of the signifier believed it to be their duty to pose at the beginning of the operation they organise, namely the notion of communication. Communication as such is not what is primal since, at the origin S has nothing to communicate for the reason that all the instruments of communication are on the other side, in the field of the Other, and because he has to receive them from him. As I have always said, this has as a result and consequence that it is always principally from the Other that he receives his own message, the first emergence, the one which is inscribed on the board is only an unconscious, because unformulatable, "Who am I?", to which there responds before it is formulated, a "You are", namely that he receives first of all his own message in an inverted form, as I have said for a long time. I am adding today if you understand it, that he receives it in a form that is at first interrupted, that he hears first of all a "You are..." without attribution. And, nevertheless, however interrupted this message may be and therefore however insufficient, it is never unformed, starting from this fact that language exists in the real, that it is on a journey, in circulation, and that for its part the S , in its supposedly primal interrogation, that with regard to it, many things in this language are already regulated.

Now to take up a phrase I used earlier, it is not simply by hypothesis, a hypothesis that I founded in our very own practice, identifying it with this praxis and up to its limits, to take this phrase up again, I would say that observable facts - and why so badly observed, this is the major question that experience

presents to us - observable facts show us the autonomous operation of the word as it is presupposed in this schema. I think that there are here enough mothers not afflicted with deafness to know that a very small child, at the age when the mirror phase is far from having finished its work, that a very small child, once he has a few words, monologues before he goes to sleep.

Time prevents me today from reading for you a big page. I promise you something satisfying from it the next time or the one after that; for undoubtedly I will not fail to do it. As luck would have it, after my friend Roman Jakobson had for ten years begged all his pupils to put a tape recorder in the nursery, it only happened two or three years ago. Thanks to this, we finally have a publication of one of those primordial monologues, and I repeat that you will get some satisfaction from it. If I make you wait a little, it is because, in truth, it is useful for showing you a lot of other things that I want to outline today.

It is necessary all the same for what I have to outline today, to evoke the references of existence, as regards which the fact that I can only do so without knowing too much about what may (7) correspond to it in your own knowledge, shows the degree to which we are fated to move around in a field in which, whatever one thinks about it and whatever expense in terms of courses and conferences about it are made, your education is nothing less than adequate.

In any case, if some people here remember what Piaget calls egocentric language, to which I do not know whether we will be able to return this year - I think that you know what it is and that under a name that is perhaps defensible, but is undoubtedly open to all sorts of misunderstandings - there is for example, this characteristic that egocentric language, namely these sorts of monologues a child carries on aloud, when he is set to a common task with some comrades, which is very obviously a monologue directed at himself, can only be produced precisely in a certain community. This is not to object to the qualification of egocentric, if one specifies the meaning of this "egocentric" - in any case, as regards egocentrism, it may appear striking that the subject as enunciated is so often elided in it. I recall this reference, it is perhaps to encourage you to make contact again and get to know the phenomenon in the text of Piaget for any useful end it may have in the future, but also to note that at least a problem is posed: that of situating, of knowing what is this hypnopompic monologue, which is quite primal compared to this manifestation, as you know, of a much later stage.

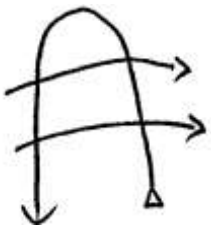

Here and now, I indicate to you that as regards these problems, as you see, of genesis and of development, this famous schema which has bored you so much throughout these years, will regain its value. In any case, this monologue of the small child that I am speaking to you about, never happens when someone else is there: a younger brother, another

baby in the room, is enough for it not to happen. Many other characteristics indicate that what is happening at this level, which, as you -will see, is so astonishingly revelatory of the precociousness of what are described as the primordial tensions in the unconscious, we cannot doubt that we have here something that is at every point analogous to the function of the dream.

Everything happens on "another stage" with the accent that I have given to this term. And ought we not to be guided here by the little door itself - it is never anything but a bad way through which I introduce you here to the problem - namely concerning what is involved, which is the constitution of o as remainder, that in any case, if its conditions are indeed the ones I have (8) told you about, we for our part only have this phenomenon in the state of a remainder, namely on the tape of the recorder. In other words, we have at the very most the distant murmur that is always ready to be interrupted when we appear.

Does this not prompt us to consider that a way is presented to us to grasp that for the subject who is in the process of constituting himself, it is also in a voice detached from its support that we ought to search for this remainder.

Pay very careful attention: we must not go too quickly here. Ordinary experience is that everything the subject receives from the Other through language is received in a vocal form. But we know very well, in an experience which is not all that rare, even though one evokes always the most spectacular cases, Helen Keller, that there are ways other than the vocal one to receive language, there are other ways for receiving language, language is not vocalisation (cf the deaf).

Nevertheless, I believe that we can advance in the direction that a relationship that is more than accidental links language to sonority. And we will believe perhaps that we even are advancing along the right path in trying to articulate things closely in qualifying this sonority, for example, as instrumental. It is a fact that physiology opens the path here. We do not know everything about the functioning of the ear, but we know all the same that the cochlea is a resonator, a complex or composite resonator, if you wish, but after all a composite resonator is decomposed into a composition of elementary resonators. This leads us along a path which is the following, that what is proper to resonance is that it is the apparatus which dominates in it. It is the apparatus which resonates. It does not resonate to just anything, it only resonates, if you wish, in order not to complicate things too much, to its own note, to its own frequency.

This leads us to a certain remark about the sort of resonator that we are dealing with, I mean concretely, in the sensory apparatus in question, our ear: to a resonator which is not an indifferent one, to a resonator which is a kind of tube. The distance of the journey involved in a certain return that the vibration makes, always carried from the oval window, passing from the scala tympani to the scala vestibuli, appears to be

closely linked to the length of the space travelled in a closed conduit. It operates therefore in the same way, if you wish, as some tube, whatever it may be, a flute or an organ.

(9) Obviously the matter is complicated, this apparatus does not resemble any other musical instrument. It is a tube which could be, as I might say, a tube with keys, in this sense that it seems that it is the cell put in the position of a cord, but which does not function like a cord, which is involved at the point of the return of the wave, which takes charge of connoting the resonance involved.

I apologise all the more for this detour because it is quite certain that it is not in this direction that we will find the last word on the matter. This reminder is all the same designed to actualise the fact that in the form, the organic form, there is something which appears to us akin to these primary, topological, transpatial data which made us interest ourselves very especially in the most elementary form of the created or creative constitution of a void, the one that we have incarnated in the form of an apologetic for you in the story of the pot.

A pot also is a tube, and one that can resonate. And the question of what we have said, that ten absolutely similar pots absolutely do not fail to impose themselves as individually different, but the question can be posed as to whether if, when one puts one in the place of the other, the void which was successively at the heart of each one of them is always the same.

Now, it is indeed from the commandment which imposes the void at the heart of the acoustic tube for anything of this reality which may resonate there which opens out onto a further step of our progress, which is not so simple to define, namely what is called a breath, namely that for all possible breaths, a flute at the level of one of its openings imposes the same vibration. If it is not the law, indicating for us this something where the o involved, functions with a real function of mediation.

Well now let us not yield to this illusion. All of this is only of interest as a metaphor. If the voice, in the sense that we understand it, has an importance, it is not that of resonating in any spatial void, it is in so far as the formula, the most simple elision in what is called linguistically its phatic function, which is believed to be a simplemaking contact, which is indeed something else, resonates in a void which is the void of the Other as such, the ex nihilo properly speaking. The voice responds to what is said, but it cannot answer for it. In other words: in order for it to respond, we have to incorporate the voice as otherness of what is said.

(10) It is indeed for this reason, and not for any other, that detached from ourselves, our voice appears to us to have a strange sound. The structure of the Other, in itself, constitutes a certain void, the void of its lack of guarantee. The truth enters the world with the signifier and before any control. It is experienced, it refers itself on only by its

echoes into the real. Now, it is in this void that the voice qua distinct from sonorities, the not modulated but articulated voice resonates. The voice involved, is the voice qua imperative, in so far as it calls for obedience or conviction, that it situates itself, not with respect to music, but with respect to the word.

It would be interesting to see the distance that exists, in connection with this well-known miscognition of the recorded voice, between the experience of the singer and that of the orator. I propose to those who are willing to do some research for free on this, to do it: I do not have the time to do it myself.

But I believe that it is here that we put our finger on this distinct form of identification that I was not able to approach last year, which ensures that the identification of the voice gives us at least the first model which ensures that in certain cases we are not speaking about the same identification as in the others, we speak about Einverleibung, of incorporation.

The psychoanalysts of the right generation were aware of this. There was a certain Mr Isakover who wrote in the 20th year of the International Journal a very remarkable article which moreover to my mind is only of interest because of the need he felt to give a really striking image of what was distinct in this type of identification. Because, as you will see, he is going to look for it in something whose relationships - as you will see - are singularly more distant from the phenomenon than For that purpose, if he interests himself in the little animal which is called the [Palaemon], if I remember rightly, because I have not had time to check this memory - which is called, I believe, Daphnia and which without being at all a shrimp you can present it to yourself as greatly resembling it. In any case, this animal which lives in salt water has the curious habit, as we would say in our language, of plugging the shell during its metamorphoses with tiny grains of sand, of introducing them into what it has in terms of a reduced apparatus described as (11) stato-acoustic, in other words into the utricles - for it does not have our extraordinary cochlea - into the utricles, having introduced these lumps of sand - because it has to put them in from outside, because it does not produce them of itself in any way - the utricle closes again and here it is inside these little bells that are necessary for its equilibrium. It brings them in from outside. You must admit that the relationship with the constitution of the superego is rather distant; nevertheless what interests me, is that Mr Isakover did not think he could find any better comparison than to refer himself to this operation. You have all the same, I hope, heard being awakened in yourselves the echoes of physiology, and you know that malicious experimenters substituted grains of steel for grains of sand, as a way of amusing themselves subsequently with the Daphnia and a magnet.

A voice therefore is not assimilated but it is incorporated, this is what can give it a function in modelling our void. And we rediscover here my instrument of the other day, the shofar of the

synagogue. What gives its meaning to this possibility that for an instant it can be entirely musical - is this elementary fifth even music, this deviation of a fifth in it? - that it can be a substitute for the word, by powerfully wrenching our ear away from all its customary harmonies. It models the locus of our anxiety, but, let us note, only after the desire of the Other has taken the form of a commandment. That is why it can play its eminent function of giving to anxiety its resolution, whether it is called guilt or pardon, and which is precisely the introduction of a different order. The fact that desire is a lack is fundamental here, we will say that it is its "primordial fault", fault in the sense that something is lacking (fait default). Change the meaning of this fault by giving it a content in the articulation of what? Let us leave it in suspense. And this is what explains the birth of guilt and its relationship to anxiety.

In order to know what can be made of it, it is necessary for me to lead you into a field which is not that of this year, but which we must engage a little with here. I said that I did not know what, in the shofar, let us say the clamour of guilt, is articulated from the Other who covers anxiety. If our formula is correct, something like the desire of the Other must be involved in it.

I will give myself three more minutes to introduce something which prepares the way and next time we will be able to take our next step, namely to tell you that what is here most favourably prepared to be illuminated reciprocally, is the notion of (12) sacrifice.

Many other people besides me have tried to tackle what is involved in sacrifice. I will tell you - we are short of time - briefly, that sacrifice is destined, not at all to be an offering or a gift which spreads itself into a quite different dimension, but to be the capture of the Other as such in the network of desire.

The matter should already be perceptible, namely what it is reduced to for us on the ethical plane. It is a common experience that we do not live our lives, whoever we are, without ceaselessly offering to some unknown divinity or other the sacrifice of some little mutilation that we impose on ourselves, validly or not, in the field of our desires

Not all the underpinnings of the operation are visible. That it is a matter of something which refers to o as pole of our desire is not in doubt. But it will be necessary, the next time, for me to show you that something more is necessary, and specifically - I hope that at this meeting I will have a large convent of obsessionals - and specifically that this o is something already consecrated, which is something that cannot be conceived of except by taking up again in its original form what is involved in sacrifice.

We no doubt have for our part, lost our gods in the great fair of

civilisation, but a rather prolonged time at the origin of all peoples shows that there is linked into them from the beginning like real persons, not omnipotent gods, but gods powerful where they were. The whole question was to know whether these gods desired something. Sacrifice consisted in behaving as if they desired like us: therefore o has the same structure. That does not mean that they are going to eat what is sacrificed to them, nor even that it can be of any use to them; but the important thing is that they desire it and, I would say further, that this does not provoke anxiety in them.

For there is something else that up to the present no one, I believe, has resolved in a satisfactory fashion: the victims always had to be without stain. Now remember what I told you about the stain at the level of the specular field: with the stain there appears, there is prepared the possibility of the resurgence, in the field of desire, of what is hidden behind, namely in this case this eye whose relationship with this field must necessarily be elided in order that desire can remain there with this ubiquitous, even vaqabond possibility, which in any case allows it to escape from anxiety. To tame the god in the snare of desire is essential, and not to awaken anxiety.

Time forces me to end. You will see that, however lyrical this last diversion may appear to you, it will serve us as a guide in the much more day-to-day realities of our experience.

Seminar 22: Wednesday 12 June 1963

Anxiety lies in this fundamental relationship that the subject is in with what I have called up to now the desire of the Other.

Analysis has, has always had and keeps as its object the discovery of a desire. It is - you will admit - for some structural reasons that I am led, this year, to disengage, to bring into function as such in a circumscribed, articulated way, and this just as much by what we could call an algebraic definition, as by an articulation in which the function appears in a sort of gap, of residue of the signifying function as such; but I also did it piece by piece, this is the path that I will take today.

In every advance, in every becoming of this o as such, anxiety appears precisely in function of its relationship to the desire of the Other. But what is its relationship to the desire of the subject? It is absolutely situatable in the form that I already advanced at the appropriate time: o is not the object of desire, the one that we search to reveal in analysis, it is its cause.

This feature is essential; for if anxiety marks the dependency of every constitution of the subject - his dependency on the Other - the desire of the subject is thus found appended to this relationship through the mediation of the first, antecedent constitution of o.

This is the interest that pushes me to remind you how this presence of o as cause of desire announces itself. From the first data of analytic research, it announces itself in a more or less veiled fashion precisely in the function of the cause.

This function can be mapped out in the data of our field, the one in which research engages, namely the field of the symptom. In every symptom, in so far as a term of this name is what interests us, this dimension that I am going to try to bring into play today before you manifests itself. To make you sense it, I will start from a symptom which it is not for nothing has - as you will see after the event - this exemplary function, namely the symptom of the obsessional. But - I am indicating it right away - if I put it forward, it is because it allows us once again to go into this mapping out of the function of o, in so far as it unveils itself functioning in the first givens of the symptom in

the dimension of the cause.

(2) What does the obsessional present to us in the pathognomic form of his position? The obsession or the compulsion, articulated or not as a motivation in his inner language: "Do this or that; check whether the door is closed or not, whether the tap is on". As we will see later perhaps, it is the symptom which takes in its most exemplary form, implies as I might say, that not following the line awakens anxiety. It is this which brings it about that the symptom, I would say, indicates in its very phenomenon that we are at the most favourable level to link the position of o as much to the relationships of anxiety as to the relationships of desire.

Anxiety, in fact, appears - because desire, at the beginning, historically before Freudian research, before the analysis of our praxis, is hidden, and we know the trouble we have to unmask it, if we ever do unmask it!

But here there deserves to be highlighted this datum of our experience which appears from the very first observations of Freud and which, I would say, constitutes, even if it has not been situated as such, perhaps the most essential step in the advance into obsessional neurosis, it is that Freud, and we ourselves every day have recognised, can recognise this fact that the analytic procedure does not begin from the enunciation of the symptom as I have just described it to you, namely according to its classical form, the one which had already been defined much earlier, the compulsion with the anxious struggle which accompanies it, but in the recognition of the following: the fact is that it functions like that. This recognition is not an effect detached from the functioning of this symptom, it is not epiphenomenally that the subject has to perceive that it functions like that.

The symptom is only constituted when the subject becomes aware of it; because we know from experience that there are forms of obsessional behaviour in which the subject, not only has not noticed his obsessions, but has not even constituted them as such. And the first step, in this case, of the analysis - the passages of Freud on this point are celebrated - is that the symptom is constituted in its classical form. Without this, there is no means of getting out of it and not simply because there is no way of speaking about it, but because there is no way of catching it by the ear. What is this ear in question? It is this something of the symptom that we can say is unassimilated by the subject.

(3) In order for the symptom to emerge from the state of an as yet unformulated enigma, the step is not that it should be formulated, it is that in the subject something should be outlined whose character is that it is suggested to him that there is a cause for that. This is the original dimension taken on here in the form of the phenomenon, and I will show you besides where one can rediscover it.

This dimension - that there is a cause for that - in which simply the implication of the subject in his behaviour is broken, this rupture is the necessary complement for the symptom to be approachable by us. What I intend to say to you and to show you, is that this sign does not constitute a step in what I could call the understanding of the situation, that it is something more, that there is a reason why this step is essential in the treatment of the obsessional.

This is impossible to articulate if we do not display in an altogether radical fashion the relationship between the function of o, the cause of desire, and the mental dimension of cause as such. This, I already indicated in what I might call some asides in my discourse, and I wrote it somewhere at a point that I could find again in the article "Kant with Sade" which appeared in the April edition of the journal Critique. It is on this point that I intend today to bring to bear the main part of my discourse.

From now on you see the interest in marking, in making it likely, that this dimension of the cause indicates - and only indicates - the emergence, the presentification, in the starting data of the analysis of the obsessional, of this o around which - this is in the future of what I am trying for the moment to explain to you - around which there has to turn the whole analysis of the transference in order not to be obliged, required to turn in a circle. A circle certainly is not nothing, the circuit is gone through; but it is clear that there is - and I am not the one who enounced it - a problem about the end of the analysis, one which is enounced as follows: the irreducibility of a transference neurosis. This transference neurosis is or is not the same as the one which was detectable at the beginning. Undoubtedly it is different in being entirely present, it appears to us sometimes in an impasse, that is to say sometimes culminates in a complete stagnation of the relationships between the analysand and the analyst. Its only difference to everything that is produced in an analogous way, at the beginning of the analysis, is that it is completely collected together.

(4) One enters analysis through an enigmatic door: for the transference neurosis is there in each and every one, even in Alcibiades: it is Agathon that he loves. But in a being as free as Alcibiades, the transference is obvious. Even though this love is what is called a real love, what we too often call a lateral transference, this is where the transference is. The astonishing thing is that one goes into analysis despite all the things that hold us back in the transference functioning as real.

The real subject of astonishment as regards the circuit of the analysis, is how, going into it despite the transference neurosis, one can obtain the transference neurosis itself on the way out. No doubt it is because there is some misunderstanding about the analysis of transference. Without this one would not see there being manifested sometimes, this satisfaction which I have heard expressed, that to have given energy to this transference neurosis is not perhaps perfection, but it is all the same a result; it is true - but it is all the same a result

that is itself rather perplexing.

If I enounce that the path passes through o, the only object to be proposed for analysis, for the analysis of transference, this does not mean that this does not leave open, as you will see, another problem. It is precisely in this subtraction that there can appear this essential dimension, that of a question always posed, in short, but certainly not resolved - for every time it is posed the inadequacy of the answers is really tangible, evident, striking to every eye - that of the desire of the analyst.

This short reminder to show you the interest of what is presently at stake, this short reminder having been given, let us return to o. o is the cause, the cause of desire. I pointed out to you that to return to the enigma which the functioning of the category of the cause proposes to us is not a bad way of understanding it. For after all it is quite clear that whatever critique, whatever effort of reduction, phenomenological or not, that we apply to it, this category functions, and not simply as an archaic stage of our development.

What is indicated by the way in which I intend to refer it here to the original function of the object o as cause of desire, signifies the transference of the question of the category of causality, from what I would call with Kant the transcendental aesthetic, to that which - if you are willing to agree to it - I would call my "transcendental ethics".

(5) And here I am forced to advance onto a terrain that I am forced to propose simply, in order to sweep the sides of it with a searchlight. Without being able even to insist, it would be well, I would say, for the philosophers to do their work and notice for example, and dare to formulate something which would allow us truly to situate in its place this operation which I am indicating in saying that I extract the function of cause from the field of "the transcendental aesthetic", from that of Kant, it would be fitting for others to indicate to you that this is only a sort of completely pedagogical extraction, because there are many things, other things, that it would be fitting to extract from this "transcendental aesthetic".

Here I have to do, at least by way of indication, what I succeeded in eluding the last time by a conjuring trick, when I spoke to you about the scopic field of desire. I cannot avoid it. It is necessary all the same that I say, that I indicate here, at the very moment that I am advancing further, what was implied in what I was telling you, namely that space is not at all an a priori category of sensible intuition, that it is very astonishing that at the point of advancement that we are at in science no one has yet attacked directly something that everything encourages us to do: to formulate that space is not a feature of our subjective constitution beyond which the thing in itself would find, as one might say, a free field, namely that space forms part of the real, and that, after all, in what I enounced, articulated, drew here before your eyes last year with

all this topology, there is something whose note some of you certainly felt: this topological dimension, in the sense that its symbolic handling transcends space, evoked for many, not only for some, so many shapes which are presentified for us by the schemas of the development of the embryo, shapes that are singular through this common singular Gestalt which is theirs and which carries us very very far from the direction in which the Gestalt has advanced, namely in the direction of the good shape, shows us, on the contrary something which is everywhere reproduced, and regarding which, in an impressionistic notation, I would say that it is tangible in a sort of torsion to which the organisation of life seems to be obligated in order to lodge itself in real space.

The thing is everywhere present in what I explained to you last year, and also moreover this year, for it is precisely at these points of torsion that there are also produced the points of (6) rupture whose importance I tried to show you in more than one case in a fashion linked to our own topology, that of the S, of the 0 and the of the o, in a fashion which is more efficacious, more true, more conform to the operation of functions than anything that is mapped out in the doctrine of Freud, in the way that the differences, the vacillations are themselves already indicative of the necessity of what I am doing there, which is linked to the ambiguity on his part for example about the relationships between ego/non-ego, container/contained, ego/outside world. It leaps to the eyes that all of these divisions do not overlap. Why?

It is necessary to grasp what is involved and to have found other reference points of this subjective topology that we are exploring here. I will finish with it with this indication, whose import I know that at least some of you know very well from having heard me now, that the reality of space qua three dimensional space is something essential to grasp in order to define the form taken at the level of the stage that I tried to illuminate in my first lecture, as the function of the scopic stage, the form taken on there by the presence of desire, specifically as phantasy, namely that what I tried to define in the structure of the phantasy, namely the function of the frame - understand by that the window - is not a metaphor. If the frame exists, it is because space is real.

As regards the cause, let us try to grasp in the very thing which is the common undergrowth of the understandings you have which are bequeathed to you from a certain hubbub of philosophical discussions because of having passed through a class designated by this name, La Philosophie, because it is quite clear that an index of this origin of the function of the cause is very clearly given us in history by the following: the fact is that it is in the measure of the critique of this function of cause, of the attempt to remark that it is ungraspable, that what it is necessarily, is always at least a cause behind a cause, and what is necessary for it to be other in order to be equivalent to this incomprehensible, without which moreover we cannot even begin to articulate anything whatsoever. But of course, this critique has

its fecundity and one sees it in history: the more the cause is criticised, the more the exigencies that one can describe as those of determinism impose themselves on thought. The less the cause is graspable, the more everything appears caused, and up to (7) the final term, the one that has been called the meaning of history.

One can say nothing other than that "everything is caused", except for the fact that everything that happens there presides and always begins from a "sufficiently caused", in the name of which there is reproduced in history a beginning, an un-caused which I would not dare to call absolute, but which was certainly unexpected and which classically leaves lots of work to be done nachträglich by the prophets, which is the daily bread of the aforesaid prophets, who are the professional interpreters of the meaning of history.

Now let us say very simply how we envisage this function of the cause. We envisage it, this function everywhere present in our thinking about the cause, I would say first of all to make myself understood, as the shadow cast, but very precisely and better the metaphor of this primordial cause, substance of this function of the cause which is precisely the o qua anterior to all this phenomenology. We have defined o as the remainder of the constitution of the subject at the locus of the Other in so far as it has to constitute itself as a speaking subject, a barred subject, \$.

If the symptom is what we are saying, namely entirely implicatable in this process of the constitution of the subject, in so far as he has to construct himself in the locus of the Other, the implication of the cause in the becoming of the symptom as I defined it for you earlier, is a legitimate part of this becoming. This means that the cause implicated in the question of the symptom is literally, if you wish, a question, but one of which the symptom is not the effect. It is the result of it. The effect is the desire. But it is a unique effect and quite strange in that it is what is going to explain to us, or at the very least make us understand, all the difficulties that arose from linking the common relationship which is imposed on the mind between the cause and the effect. The fact is that the primordial effect of this cause, o, at the level of desire, this effect which is called desire and this effect which I have just qualified as strange since, you should note, since it is precisely desire, it is an effect which has nothing effected about it.

Desire taken in this perspective is situated in effect essentially as a lack of effect. The cause is thus constituted as supposing the effects of the fact that primordially the effect is lacking there. And this is rediscovered, you will rediscover it, in every phenomenology. The gap between cause and effect, in the measure that it is filled - this indeed is what is called in a certain perspective the progress of science - makes the (8) function of the cause vanish, I mean there where it is filled.

Moreover the explanation of anything whatsoever culminates in the measure that it is completed, in leaving only signifying connections, in volatilising what animated it at its origin, what was pushing to be explained, namely what one does not understand, namely the effective gap. And there is no cause which is constituted in the mind as such, which does not imply this gap. All of this may seem to you quite superfluous. Nevertheless this is what allows there to be grasped what I would call the naivety of some of the research done by psychologists and specifically that of Piaget.

The paths along which I am leading you this year - you have already seen it announcing itself - pass by way of a certain evocation of what Piaget calls "egocentric language". As Piaget himself recognises - he has written it, I am not interpreting him here - **hi3** idea of the egocentricity of a certain childish discourse starts from this supposition: he believes he has demonstrated that children do not understand one another, that they speak for themselves.

The world of suppositions that lies beneath this is, I would not say unfathomable; one can specify them for the greater part: it is an excessively wide-spread supposition, namely that the word is made to communicate. That is not true. If Piaget cannot grasp this sort of gap there again which he himself nevertheless designates - and this is really what is important in reading his works, I beg you between now and the time that I return or I do not return, to get hold of The language and thought of the child which is an altogether admirable book; it illustrates at every moment the degree to which what Piaget collects in terms of facts in this approach, which is aberrant in principle, demonstrates something quite different to what he thinks; naturally since he is far from being a fool, it happens that Piaget's own remarks go along that very path, in any case for example the problem as to why this language of the subject is essentially made for him, never happens in a group.

What he lacks, I would ask you to read these pages because I cannot go through them with you, but at every moment you will see how his thinking slips, clings to a position of the question which is precisely the one which veils the phenomenon which, as a matter of fact, is very clearly displayed, and the essential of it is essentially the fact that it is a different thing to say that the word has essentially for effect to communicate, while (9) the effect of the word, the effect of the signifier is to give rise in the subject to the dimension of the signified essentially. I will return to it again if necessary.

That this relationship to the other that is depicted for us here as being the key, under the name of the socialisation of language, the key to the turning point between egocentric language and completed language, this turning point is not, in its function, a point of effect, of effective impact, it is nameable as a desire to communicate. It is indeed moreover because this desire is disappointed in Piaget - it is quite tangible - that his whole pedagogy here gives rise to systems

and ghosts that are, in fact, rather affected. That the child appears to him to only half-understand him, he adds: "They do not even understand one another". But is that where the question lies?

One sees very well in his text how the question is not there. One sees it in the way that he articulates what he calls understanding between children. As you know this is how he proceeds; -he begins by taking for example the following schema which is going to be depicted on an image which is going to be the support of the explanations, the schema of a tap. That gives us something more or less like that, this being the cross-section of the tap; you say to the child, as often as necessary: "You see the little tube here - it will also be called the door - it is blocked; which means that the water there cannot get through in order to flow here into what will also be called in a certain fashion the outlet, etc".



He explains. Here is this schema, if you want to test it. He thought moreover - I point this out to you in passing - he should complete it himself with the presence of the basin which will absolutely not intervene in the six or nine, seven points of explanation that he gives us.

He will be very struck by the following: the fact is that the child repeats very well all the terms of the explanation that he, Piaget, has given him. He is going to make use of this child as an explainer for another child, whom he will bizarrely call the reproducer.

First phase: he notices, not without some astonishment, that what the child has repeated so well, which means for him that he obviously has understood - I am not saying that he is wrong, I am saying that Piaget does not even ask himself the question - that what the child has repeated to him, Piaget, in the test that he carried out with a view to seeing what the child had understood, (10) is not going to be in any way identical to what he is then going to explain. At which Piaget makes this very correct remark, that what he elides in his explanations, is precisely what the child has understood, without seeing that in giving this explanation this would imply that the child for his part would explain nothing if he had really understood everything, as Piaget says. It is of course not true that he has understood everything - as you are going to see - any more than anybody else.

With these very insufficient explanations that the explainer gives to the reproducer, what astonishes Piaget, is that in a field like that of these examples, namely the field that he calls that of explanations - because I am leaving to one side, for lack of time, the field that he describes as that of "stories".

For stories things function differently. But what does Piaget call stories? I assure you that he has a way of transcribing the

story of Niobe which is a pure scandal. Because it does not seem even to occur to him that in speaking about Niobe, one is speaking about a myth and that there is perhaps a dimension of myth which imposes itself, which absolutely clings to the simple term which is put forward under this proper name Niobe, and that to transform it into a sort of emollient hogwash - I would ask you to consult this text which is simply incredible - one is proposing perhaps to the child something within his range, which is simply something which signals a profound deficit in the experimenter, Piaget himself, with regard to what are the functions of language. If one is proposing a myth, let it be one, and not this vague little story: "Once upon a time there was a lady called Niobe who had twelve sons and twelve daughters. She met a fairy who had only one son and no daughter; now the lady mocked the fairy because she had only one boy; the fairy then became angry and tied the lady to a rock. The lady cried for ten years, and then she was changed into a stream, her tears had made a stream which still flows".

This has really no equivalent except the two other stories that Piaget proposes, that of the little black boy who breaks his cake on the way out and melts the pat of butter on the return journey, and the still worse one of children transformed into swans, who remain all their lives separated from their parents because of this curse, but who, when they return, not alone find their (11) parents dead, but regaining their first shape - this is not indicated in the mythical dimension - in regaining their first shape, they have nevertheless aged. I do not know if there is a single myth which allows the aging process to continue during a transformation. In a word, the invention of these stories of Piaget have one thing in common with those of Binet in that they reflect the profound wickedness of every pedagogical position.

I apologise to you for wandering off into this parenthesis. Let us come back to my explanations. At least you will have grasped in it this dimension noted by Piaget himself of this sort of wastage, of entropy, as I might put, of comprehension which is going to be necessarily degraded by the very fact of the explanation being necessarily verbal. He himself notes to his great surprise that there is an enormous contrast between the explanations, when what is involved is an explanatory one like that, and what happens in his "stories", "stories", that I repeat I put in inverted commas. Because it is very probable that if the "stories" confirm his theory regarding the entropy, if I may express myself thus, of comprehension, it is precisely because they are not "stories", and that, if they were "stories", the true myth, there v/ould probably be no wastage.

In any case, I for my part propose a little sign to you, it is that, when one of these children, when he has to repeat the story of Niobe, makes emerge, at the point that Piaget tells us that the lady had been tied to a rock - never, in any form, has the myth of Niobe articulated such a moment - of course, it is easy, playing, you will be told, on something misheard and on a pun, but why precisely this one makes emerge the dimension of a rock which has a stain, restoring the dimension that in my previous

seminar I made emerge for you as being essential for the victim of sacrifice, that of not having any. But let us leave it. It is of course not a proof, but simply a suggestion.

I return to my explanation and to the remark of Piaget that, despite the defects of the explanation, I mean the fact that the explainer explains badly, the one to whom he is explaining understands much better than the explainer, by his inadequate explanations, bears witness to having understood. Of course here the explanation always arises: he himself does the work again. Because how does he define the rate of understanding between children? What the reproducer has understood
What the explainer has understood

(12) I do not know if you notice that there is one thing here that is never spoken about, it is what Piaget himself has understood! It is nevertheless essential, because we do not leave the children to spontaneous language, namely to see what they understand.

Now it is clear that what Piaget seems not to have seen, is that his own explanation, from the point of view of anyone at all, of some other third person, cannot be understood at all. For as I told you earlier, if this little blocked tube here is switched on, thanks to something that Piaget gives all its importance to, the operation of the fingers which make the tap turn in such a way that the water can flow, does that mean that it flows? There are absolutely no details about this in Piaget who of course knows well that if there is no pressure, nothing will come out of the tap even if you turn it on, but who believes he is able to omit this because he is placing himself at the level of the so-called mind of the child. Let me continue. This seems to be completely stupid, all of this, but you are going to see. The coming into view, the springing forth; the meaning of the whole adventure does not emerge from my speculations, but from experience. You will see.

It emerges all the same from this remark that I have made to you - I who do not claim to have understood exhaustively - that there is one thing that is very certain: it is that the explanation of the tap is not well done, if what is involved is the tap as cause, by saying that it operates sometimes on and sometimes off. A tap is made to be turned off. It is enough that once, because of a strike, you no longer know when the pressure is going to come back to know that, if you have left it on, there are lots of inconveniences, that it ought therefore to be turned off even when there is no pressure.

Now what is marked in what happens in the transmission from the explainer to the reproducer? It is something that Piaget deplores, which is that the so called reproducer child no longer has the slightest interest in anything that is involved concerning two branches, the operation of the fingers and everything that follows from it. Nevertheless, he points out, the other has transmitted a certain part of it to him. The wastage in comprehension seems to be enormous to him; but I

assure you, if you read the explanations of the little third party, of the little reproducer, of little Riv in the text in question, you will notice that what he precisely puts the stress on, are two things: namely the effect of the tap as something (13) which can be turned off and the result, namely that thanks to a tap one can fill a basin without it overflowing, the emergence as such of the dimension of the tap as cause. Why does Piaget so completely miss the phenomenon which is produced, if not because he totally fails to recognise that what there is for a child in a tap as cause, are the desires that the tap provokes in him, namely that for example it makes him want to have a pee or, like every time one is in the presence of water, that one is with respect to that water a communicating vessel and that it is not for nothing that in order to speak to you about libido I took this metaphor of what happens between the subject and his specular image.

If man had a tendency to forget that in the presence of water he is a communicating vessel, there is in the childhood of most the washtub to remind him that effectively, what happens in a child of the age of those that Piaget designates for us, in the presence of a tap, is this irresistible type of acting-out which consists in doing something which runs the greatest risk of upsetting it, and thus the tap finds itself once again in the place of the cause, namely at the level also of the phallic dimension, as that which necessarily introduces the fact that the little tap is something which can have a relationship with the plumber, that one can unscrew, dismantle, replace... etc: it is (-^). It is not the fact of omitting these elements of experience - that moreover Piaget, who is very well informed about analytical matters, is not ignorant of - that I intend to underline, it is that he does not see the link between these relationships that we call, for our part, "complexual" and the whole original constitution of what he claims to question, the function of the cause.

We will return to this language of the child. I pointed out to you that the new evidence of original works, which one can only be astonished were not performed up to now, allows us now to grasp in statu nascendi the first operation of the signifier in these hypnopompic monologues of the very small child, almost two years old, and to grasp in them - I will read you these texts at the proper time - in the fascinating form of the Oedipus complex itself here and now; already articulated, giving here the experimental proof of the idea that I always put forward to you that the unconscious is essentially the effect of the signifier.

(14) I will finish in this connection with the position of the psychologists, for the work that I am speaking to you about is prefaced by a psychologist who is very attractive at first sight in the sense that he admits that it has never **happened** that a psychologist has interested himself-in these functions starting from, he tells us - a psychologist's own admission - from the supposition that nothing interesting is notable about the coming into play of language in the subject, except at the level of education: in effect it is something that is learned.

But what makes language, outside the field of learning? It required the suggestion of a linguist for an interest to begin to be taken in it, and we believe that here the psychologist lays down his arms. For it is certainly with some humour that he highlights this deficit in psychological research up to now.

Well that is not at all the case. At the end of his preface, he makes two remarks which show the point to which the habit of the psychologist is really inveterate. The first is that, since this constitutes a volume of about three hundred pages and is a considerable weight since these monologues were collected for a month and a complete chronological list of them was made, at this rate of going think of all the research that we are going to have to do! This is the first remark.

And the second one is even better. It is extremely interesting to note all that; but it seems to me for my part, says this psychologist who is called George Miller, that the only thing that would be interesting, is to know: "How much of that does he know?" What does the child know about what is telling you? Now it is precisely there that the question lies. It is precisely, if he does not know what he is saying, that it is very important to note that he says all the same, what he will know or will not know later on, namely the elements of the Oedipus complex.

It is ten minutes past two. I would like all the same to give you the little schema of what I am going to advance towards today concerning the obsessional. In five minutes, the question as it presents itself.

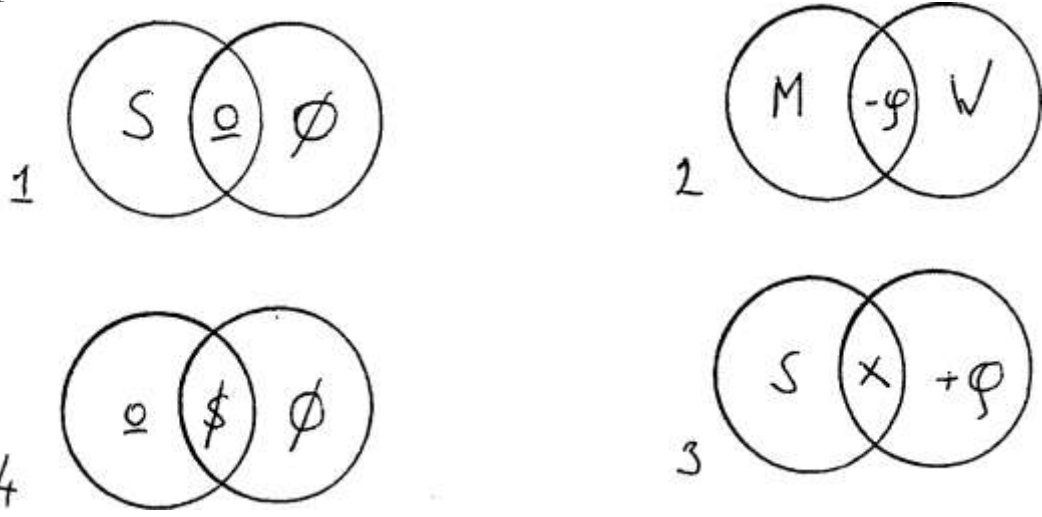

If the five stages, if I can express myself thus, of the constitution of o in this relationship of S to 0, whose first operation you see here, the second phase here not being outside the range of your understanding after the division I already added on as being the following - it is far from the transformation of S into £ when it passes from this part to that (15) one, the Euler circle having obviously to be specified - if the five stages therefore of this definition of o are definable as I am going to tell you now, if, I think, it is sufficiently posited from this resume of what I advanced step by step in the

preceding lectures at the level of the relationship to the oral object, that it is, let us say to be clear today, not need of the Other - this ambiguity is rich and we will certainly not refuse ourselves the use of it - but need in the Other, at the level of the Other, it is in function of the dependence on the maternal being that there is produced the function of the disjunction between this subject and o , the nipple, whose veritable import you will only be able to perceive if, as I very sufficiently indicated to you, you see that the nipple forms part of the inner world of the subject and not of the body of the mother. I pass on

At the second stage of the anal object, you have the demand in the Other, the educative demand par excellence in so far as it refers to the anal object. There is no way of grasping, of seizing what the veritable function of this anal object is, if you do not sense it as being the remainder in the demand of the Other, which I am calling here to make myself clearly understood "demand in the Other". The whole dialectic of what I have taught you to recognise in the function of $(-o)$ f a function unique compared to all the other functions of o in so far as it is defined by a lack, by the lack of an object, this lack manifests itself as such in this effectively central relationship - and this is what justifies the whole axing of analysis on sexuality - that we will call here jouissance in the Other.

The relationship between this jouissance in the Other as such, and any introduction of the missing instrument that $(-p)$ designates, is an inverse relationship. This is what-T articulated in my two last lectures and which is the sufficiently solid base of every sufficiently effective situation of what we are calling castration anxiety.

At the scopic stage which is properly that of phantasy, the one with which we have to deal with at the level of o , it is the power in the Other, this power in the Other which is the mirage of human desire that we condemn in what is for it the major dominant form of every possession, contemplative possession, because it fails to recognise what is involved, namely a mirage of power.

As you see I am going very quickly. At the fifth and final stage, what is there at the level of o ? Provisionally we will say that it is there that there ought to emerge in a pure form - I am saying that this is only a provisional formulation - something which is of course present at all the stages, namely the desire in the Other. What confirms it for us, in any case (16) what signals it for us in the example that we started from, namely the obsessional, is the apparent dominance of anxiety in its phenomenology. It is the structural fact that we are the only ones to perceive up to a certain moment of analysis, that whatever he does, that at whatever refinement there culminate, as there are being constructed, his phantasies and his practices, what the obsessional grasps in them - check out the bearing of this formula - is always the desire in the Other. It is in the measure of the return of this desire in the Other, in so far as

in his case it is essentially repressed, that everything is determined in the symptomatology of the obsessional, and specifically in the symptoms where the dimension of the cause is glimpsed as anxiety-provoking. The solution is known: to cover the desire of the Other, the obsessional has one way: it is to have recourse to his demand. Observe an obsessional in his biographical behaviour, what I called earlier his attempts at getting by with respect to desire. His attempts, however audacious they may be, are always marked by an original condemnation against rejoining their goal. However refined, however complicated, however luxuriant and perverse his attempts at getting by, he always has to have them authorised: it is necessary for the Other to demand it of him. This is the mainspring of what is produced at a certain turning point in every analysis of an obsessional.

In the whole measure that the analysis sustains an analogical dimension, that of demand, something subsists up to a very-advanced point - can it even be gone beyond? - of this mode of escape of the obsessional. But see what the consequences of it are. It is in the measure that the avoidance of the obsessional is the covering up of the desire in the Other by the demand in the Other, it is in this measure that *o*, the object as cause, comes to be situated where demand dominates, namely at the anal stage where *o* is, not purely and simply excrement, but like that: it is excrement qua demanded.

Now nothing had ever been analysed about this relationship to the anal object in these coordinates which are its veritable coordinates. To understand the source of what one can call anal anxiety, in so far as it emerges from an analysis of an obsessional pursued to that point - something that never happens - the veritable dominance, the character of irreducible and almost in certain cases unmasterable kernel of the apparition of anxiety at this point which ought to appear a final point, this is something that we will be able to locate the next time only on condition that we articulate everything that results from the relationship between the anal object as cause of desire and the demand which requires it, which has nothing to do with this mode of desire which is, through this cause, determining.

As someone pointed out to me after my last talk, this definition that I am pursuing this year before you of the function of the object *o*, tends to oppose to the linking of this object to stages, to what one might call the "Abrahamic" - I mean the psychoanalyst - conception of its mutations, what one might call its circular constitution, the fact that at all these levels it holds up qua object *o*, that under the different forms in which it manifests itself, it is always the same function that is involved, namely how *o* is linked to the constitution of the subject at the locus of the Other and represents it.

It is true that its central function, at the level of the phallic stage where the function of *o* is essentially represented by a lack, by the absence of the phallus as constituting the disjunction which joins desire to jouissance - this is what is expressed by what I remind you we are calling here by convention level 3 of the different stages of the object that we have described - it is true, I am saying, that this stage has what we could call an extreme position, that stage 4 and stage 5, if you wish, are in a return position which brings them into correlation with stage 1 and stage 2. Everyone knows - and this is all that this little schema is designed to recall - the links between the oral stage and its object and the primary manipulations of the super-ego, regarding which I have already indicated to you - by recalling to you the obvious connection with this form of the object *o* which is the voice - already recalled, that there cannot be a valid analytic conception of the super-ego which forgets that at its deepest phase the voice is one of the forms of the object *o*.

These two signs "an" for anal and "scop" for scopophilic recall to you the long-remarked connection between the anal stage and scopophilia. It nevertheless remains that, however conjoined, two by two, the stage-forms 1,2,3, 4,5 may be, they are all oriented in accordance with this mounting and then descending arrow. This is what ensures that in every analytic phase of the reconstitution

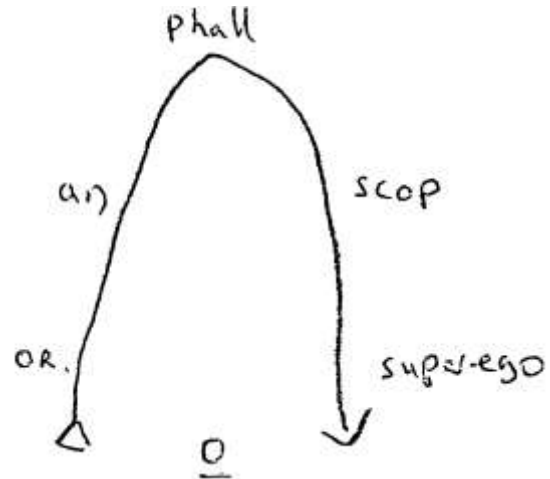

of the data of repressed desire in a regression, there is a progressive aspect, that in every progressive access to the stage here posed by the very inscription as being superior, there is a regressive aspect.

(2) Such is, such are the indications that I want to recall to you so that they may remain present in your mind throughout the whole of my discourse today, with which I am now going to continue.

As I told you the last time, it is a matter of illustrating, explaining the function of a certain object which is, if you wish, shit, to call it by its name, in the constitution of anal desire. You know after all, that it is the privilege of analysis to have made emerge in the history of thought the determining function of this unpleasant object in the economy of desire.

I pointed out to you the last time that with respect to desire, the object *o* always presents itself as a cause function, to the point of possibly being for us⁻, if you understand me, if you are following me, the root point at which there is elaborated in the subject the function of the cause itself. If this primordial form is the cause of a desire, about which I underlined for you that here there is marked the necessity through which the cause can subsist in its mental function, always requires the existence of a gap between it and its effect, a gap that is so necessary that we are only able to still think cause where there is a risk of it being filled in, we have to make a veil subsist over the tight determinism, over the connections through which the cause acts, something that I illustrated the last time by the example of the tap, namely that only the child who neglected in that case, as was said, because he did not understand, the narrow mechanism that was represented to him in the shape of a section, of a schema of the tap, only to him who dispensed with or failed at this level of what Piaget calls understanding, to him alone is there revealed the essence of the function of the tap as cause, namely as concept of tap.

The origin of this necessity for the subsistence of the cause lies in the fact that in its primary form, it is cause of desire, namely of something essentially not effected. It is indeed for this reason that consistently with this conception, we can absolutely not confuse anal desire with what mothers, as much as the partisans of catharsis, might call in this case, the effect: has it had an effect? Excrement does not play the role of effect of what we are situating as anal desire, it is the cause of it.

In truth, if we are going to dwell on this singular object, it is as much because of the importance of its function, always reiterated for our attention, and especially - as you know - in the analysis of the obsessional, as for the fact that it (3) illustrates for us, once more, how appropriate it is to conceive that there subsist, for us, different modes of the object *o*.

It is in effect, at first sight, a little apart compared to the

rest of these modes: the mammary constitution, the phallic functioning of the copulatory organ, the plasticity of the human larynx to the phonematic imprint, the anticipatory value of the specular image to the neo-natal prematuration of the nervous system, all these anatomical facts which I have recalled to you recently, one after the other, to show you the way in which they conjoin with the function of o, all these anatomical facts regarding which you can see, by simply enumerating them, the degree to which their place is dispersed under the tree of organic determinations, only take on in man their value as destiny, as Freud says, because they come, this I showed you for each one, to block out a key place on the chess board whose squares are structured from the subjectifying constitution as it results from the dominance of the subject who speaks over the subject who understands, over the subject of insight whose limits we know in the shape of the chimpanzee.

Whatever may be the supposed superiority of the capacities of man over the chimpanzee, it is clear that the fact that he goes further is linked to this dominance I have just spoken about, the dominance of the subject who speaks, which has for result in practice that the human being undoubtedly goes further. In doing this, he believes he reaches the concept, namely he believes that he is able to grasp the real by a signifier which determines this real according to its innermost causality.

The difficulties that we analysts have encountered in the field of intersubjective relationships - which the psychologists do not seem to make so much of a problem of, they constitute a rather greater one for us - these difficulties, provided we claim to account for the way in which the function of the signifier is originally mixed into these intersubjective relationships, these difficulties are the ones which lead us to a new critique of reason which it would be a kind of scholastic nonsense to see as some sort of recession in the all-conquering movement of the aforesaid reason.

This critique in effect is directed towards mapping out how this reason is already woven in at the level of the most opaque dynamism of the subject, where there is modified what he experiences in this dynamism as need into always more or less paradoxical - I say paradoxical as regards their supposed (4) naturalness - forms of what is called desire.

This critique thus proves, in what I have shown you to be the cause of desire - is it too high a price to pay? - that it has to be conjoined to this revelation that the notion of cause is found because of this to reveal its origin there. Obviously, it would be too psychologistic, with all the absurd consequences that this has concerning the legality of reason, to reduce it to a recourse, to a development of some events or other. But precisely this is not what we are doing, because the subjectification that is involved is not psychological or developmental. It shows what joins to the accidents of development - those which I first of all enumerated just now by reminding you of the list of them, the anatomical particularities

that are involved in the case of man - joining therefore to these accidents of development the effect of a signifier whose transcendence is henceforth evident with respect to the aforesaid development.

Transcendence, and then what? There is no need to be startled! This transcendence is neither more nor less marked, at this level, than any other incidence of the real, this real that in biology is called on this occasion the Umwelt as a way of taming it. And precisely the existence of anxiety in the animal completely dismisses the spiritualist imputations which, from whatever quarter, may appear in my regard in connection with this situation of the signifier that I posit as transcendent on this occasion.

On every occasion of animal anxiety what is involved is indeed a perception of a beyond of the aforesaid Umwelt. It is because something has shaken this Umwelt to its foundations that the animal shows itself to be aware when he is stampeded by an earthquake for example or any other type of meteoric accident. And once more there is revealed the truth of the formula that anxiety is what does not deceive. The proof is, that when you see animals becoming excited in this way in the regions where these incidents can occur, you would do well to take account, before you are aware of it yourself, of what they are signalling to you about what is happening, what is imminent. For them as for us, it is the manifestation of a locus of the Other, of something else which manifests itself here as such, which does not mean that I am saying - and with good reason - that there is anywhere, on the other hand, that this locus of the Other can lodge itself outside real space, as I recalled the last time.

(5) We are now going to go into the following: into the particularity of the case which ensures that excrement can come to function at this point which is determined by the necessity in which the subject finds himself of constituting himself first of all in the signifier. The point is important because after all here - perhaps more than elsewhere - a sort of shadow of confusion reigns in a singular way. One is supposed to get closer to the matter - as it is appropriately called - or the concrete, in so far as we for our part know how to take into account the most disagreeable aspects of life; that it is there, and not in the Emyrean that we have to seek precisely the domain of causes. It is very amusing to grasp in the first introductory remarks of Jones, in an article whose reading cannot be too highly recommended to you because it is one in a thousand: it is the article which in the collection of his Selected Papers is called "The Madonna's conception through the year", the conception of the Madonna, the virginal conception, the conception of the Virgin through the ear. This is the subject that this Welshman, whose Protestant malice, I have to say, can absolutely not be eliminated from the background of complacency that he puts into it, to which this Welshman attaches himself in a 1914 article, as he emerged himself precisely from his first apprehensions, which had really been illuminating for him, about the prevalence of the anal function in the first few serious

obsessionals that he had in hand, a few years after Freud's obsessionals; they are observations - I sought them out in their original text, the two editions precisely which precede the publication of this article in the Jahrbuch - they are obviously sensational dates, even though we have seen others since.

Here right away Jones tackles the subject by telling us that the fertilising breath is a lovely idea, and that everywhere in myth, in legend, in poetry, we have traces of it. What could be more beautiful than this awakening of being at the passage of the breath of the eternal! Jones for his part who knows a little bit more about it - it is true that his science is still of recent date, but in any case he is full of enthusiasm - is going to show us what sort of wind is involved: what is involved is anal wind.

And, as he tells us, it is clear that experience proves to us that the interest, and this is a presupposition, that the interest - it is the living interest, it is the biological interest, it is the interest that the subject, as he is discovered in analysis, shows in his excrements, in the shit that he produces - is infinitely more present more advanced, more (6) evident, more dominant than this something which no doubt he would have a lot of reasons to be preoccupied with, namely respiration, which scarcely seems, according to Jones, to attract his attention, and this for the simple reason, of course, that respiration is habitual.

The argument is weak. The argument is weak in a field, a discipline, which all the same cannot fail to highlight, and which subsequently highlighted, the importance of suffocation, of respiratory difficulty, in the altogether original establishment of the function of anxiety. That the living subject, even the human subject, that the living subject has not in this respect any warning about the importance of this function is surprising; I mean surprising as an initial introductory argument by Jones, especially since it is at the time where all the same there was already something well designed to highlight the eventual relationship between the respiratory function and what is involved: the fruitful moment of the sexual relationship; it is that this breathing, in the form of paternal or maternal panting, formed part indeed of the first phenomenology of the traumatic scene, to the point of entering quite legitimately into this sphere of what could emerge from it for the child in terms of sexual theory.

So that whatever may be the value of what Jones subsequently deploys, one can say that without it having to be refuted - for it is a fact that the path on which he engages here finds so many correlates in a mass of anthropological domains that one cannot say that his research indicated nothing, I am not speaking about the fact that one can easily find all sorts of references in mythological literature to the function of this lower breath, and even in the Upanishads where under the term Apana it is supposed to be specified that it is from the breathing of his behind that Brahma generated the human species in particular; there are a thousand other correlates designed to remind us on this occasion

of the timeliness in such a text of these reminders - in truth on the particular subject, if you consult this article, you will see that its very extension, which borders on diffidence, sufficiently shows that in the end it is not - far from it - absolutely convincing.

But this is for us only a further stimulation, when it is a matter of questioning the subject about how it is that the function of excrement can play this privileged role in this mode (7) of subjective constitution which we define, to which we give the term, as being that of anal desire.

We will see that by taking it up again, we will see that this can only be settled by making intervene in a more ordered, more structural fashion, which is in accord with the spirit of our research, why it can come to occupy this place.

It is obvious that, apriori, this function of excrement which as compared to the different accidents that I evoked earlier, from the anatomical place of the mammary to the plasticity of the human larynx, and in between the specular image of castration linked after all, in short, to the particular conformity of the copulatory organ at a rather elevated level of the animal scale, excrement has been there from the beginning and even before the differentiation between the mouth and the anus: at the level of the blastopore, we already see it functioning. But it seems that if we construct for ourselves - it is always inadequate - a certain biological idea about the relationships of the living being and his milieu, excrement is characterised, all the same, as something rejected and as a consequence it is rather in the sense, in the current, in the flow of that which the living being as such tends to disinterest himself in. What interests him is what enters; what goes out, seems to imply in the structure that he has no tendency to retain it.

So that starting precisely from biological considerations, it may be indicated, it seems interesting to ask ourselves exactly how at the level of the living being it takes on this importance, this subjectified importance, because of course it is possible and it is even probable, and it is even observable that at the level of what one could call the living economy, excrement continues to have its importance in the milieu that it can manage also in certain conditions to saturate, to saturate sometimes to the point of rendering it incompatible with life; other times, when it saturates it in a fashion which at least for other organisms only takes on a function of support in the external milieu. There is a whole economy, of course, of the function of excrement, an intra-living and an inter-living economy.

Nor is this absent from human happenings, and I searched in vain in my library to show, to get you started on this track - I will find it again, it is lost, like excrement, an admirable little book, like many others by my friend Aldous Huxley, called Adonis and the Alphabet. Within this promising container you will find (8) a superb article about a factory-type organisation, in a town in the American West, for the recuperation of excrement at the

urban level.

This has value only as an example, this happens in many other places besides industrial America. You certainly have not the slightest suspicion of the riches that can be reconstituted simply with the help of the excrements of a mass of humans. Besides it is not untimely to recall in this connection what a certain progress of interhuman relationships, of human relations, which is so much in vogue since the last war, was able to do during the aforesaid last war in terms of the reduction of entire human masses to the function of excrement. The transformation of numerous individuals of a people, chosen precisely because they were a people chosen among others, by means of the crematory furnace, to the state of something which finally, it appears, was distributed in Mittel europa as soap, is also something which shows us that in the economic circuit the perspective of man as being reducible to excrement is not absent.

But we analysts for our part we limit ourselves to the question of subjectification. Along what path does excrement enter into subjectification? Well, this is quite clear in the analytic references, where at least at first sight it appears quite clear, through the mediation of the demand of the Other represented in this case by the mother. When we have found that, we are quite content; here we have connected up with observational data: it involves education in what is called cleanliness, which commands the child to retain - this is something that is not all that obvious; the choice: the necessity to retain for too long a time - to retain the excrement and because of this already to outline its introduction into the domain of belonging, of a part of the body, which for at least a certain time must be considered as not to be alienated, then after that to release it, always on demand. We know the familiar scenes. They are fundamental, in common use: there is no need to criticise, nor to refrain, nor above all, good God, to accompany it with a lot of recommendations; the education of parents, always on the agenda, causes all too much damage in all these domains. After all, in short, thanks to the fact that the demand also becomes here a determining part in the releasing in question, to do something different here, which (9) quite obviously is destined to valorise this thing recognised for a moment and henceforth elevated to the function, all the same, of a part which the subject has some apprehension he is taking on, this part becoming at least valorised by the fact that it gives its satisfaction to the demand of the Other, besides being accompanied by all the caring we know about, in the measure that the other, not only pays attention to it, but adds to it all these supplementary dimensions that I do not need to evoke - it is like physics-for-fun in other domains - the sniffing, the approval, even the wiping, whose erotogenic effects are incontestable as everyone knows. They become all the more obvious when it happens - and as you know its not rare - that a mother continues to wipe her son's bottom until he is twelve years old. That is seen every day, so that of course, it would seem - my question is not all that important - that we see very well how the caca very easily takes on this function that I have called, God knows, that of agalma, an agalma whose passage after

all to the register of the nauseating only occurs as an effect of the discipline itself of which it is an integral part.

Well then, it is precisely - that leaps to the eyes - something that would not allow you to state in any way, nevertheless, in a way that could satisfy us, the fullness of the effects which are attached to this special agalmatic relationship of the mother to the excrement of her child, if it were not necessary, to understand it, to put it, which is the factual data of analytic understanding, to put it into connection with the other forms of o, with the fact that the agalma in itself is not conceivable without its relationship to the phallus, to its absence and to phallic anxiety as such. In other words, it is qua symbolising castration - we know it right away - that the excremental o has come within the range of our attention.

I propose, I add, that we can understand nothing about the phenomenology - which is so fundamental for all our speculation - of obsession, if we do not grasp at the same time in a much more intimate, motivated, regular way than we habitually do, this link between excrement and, not just the (-<p) of the phallus, but with the other forms evoked here in what we could call the classification of stages, the other forms of o.

(10) Let us take things up regressively, with the reservation that I made at first, that this regressive has necessarily a progressive aspect. What is involved is grounded at the level of the oral stage: the fact is that the object o at the oral stage, the breast, the nipple, as you wish, the subject constituting himself originally, as much as completing himself, in the commandment of the voice, the subject does not know, cannot know the degree to which he is himself this being stuck on the breast of his mother in the form of the nipple. After also having been this parasite plunging his villosities into the uterine mucus in the form of placenta, he does not know, he cannot know that o, the breast, the placenta, is the reality of himself, of o with respect to the Other, 0. He believes that o is the Other; that in dealing with o, he is dealing with the Other, with the big Other, the mother.

Therefore compared to this stage, the anal level is the first time that he has occasion to recognise himself in something - but let us not go too quickly - in something, in an object around which there turns - for it turns - this demand of the mother, that is involved: "Hold onto it; give it up". And if I give it up, where does it go? There is no need all the same for those who have the slightest analytical experience, for the others, good God, who only read about it provided they open what I called the psychoanalytic dunghill, analytical literature, I do not need - dunghill means a little pile of shit - I do not need to remind you of the importance of these two phases, their determining importance for what? This little pile in question this time, is the one I spoke about just now; this little pile of shit, is obtained on demand, it is admired: "What lovely caca!". But this demand also implies at the same time that it should be as I might say disavowed, because he is taught all the same that he must not

have too many relationships with this lovely caca, except along the well known path that analysis has also picked out, of sublimated satisfactions: if one smears, obviously everyone knows that it is with that that one does it: but one prefers all the same to indicate to the child that it is better to do it with something else, with the little plastics of the child analysts, or with nice colours that do not smell so badly.

We find ourselves there then at the level of a recognition. What is there in this first relationship to the demand of the Other, (11) is at once him and something that must not be him; or at the very least and even more, it is not from him.

Well now we are making progress, these satisfactions are being delineated, which means that we could easily see here the whole origin of obsessional ambivalence in a certain fashion; this is, in effect, something that we can see being inscribed in a formula whose structure we recognise: o is here the cause of this ambivalence, of this yes and no: it is from me - symptom - but nevertheless it is not from me. The bad thoughts that I have vis-a-vis you the analyst, obviously I indicate them, but after all it is not at all true that I consider you to be a shit, for example. So that in short we see here, in any case, an order of causality which is being sketched out, that we cannot, all the same, immediately ratify as being that of desire.

But in any case it is a result, as I was saying the last time, in speaking precisely in a general fashion about the symptom, at this level, if you wish, a structure is outlined which is of something which would give us immediately that of the symptom, of the symptom precisely as result. I point out that it still leaves outside its circuit the thing that interests us, what interests us if the theory that I expose to you is correct, namely the liaison to what is properly speaking desire. We have there a certain relationship of the constitution of the subject as divided, as ambivalent, in relation to a demand of the Other. We do not see why all of this, for example, should not pass completely into the background, should not be swept away with the introduction of the dimension of something which is supposed to be henceforth completely external, foreign, the relationship of desire and specifically that of sexual desire.

In fact we already know why sexual desire does not sweep it away, far from it. The fact is that this object manages, by its very duplicity, to symbolise marvellously, at least through one of its phases, what is involved with the advent of the phallic stage, namely this something which it is precisely a matter of symbolising, namely the phallus, in so far as its disappearance, its aphanisis - to employ Jones term, the one Jones applies to desire and which does not apply to the phallus - that his aphanisis is the go-between in man of the relationships between the sexes.

(12) Is there any need, in order to justify what begins to function here, namely that the evacuation of the result of the anal function qua commanded, is going to take on all its import

at the phallic level as imaging the loss of the phallus. It is clearly understood that all of this is only valid within the reminder that I have to give once more to the thinking of some people who may have been absent from what I previously said, about the essential nature of this central (-<P) phase, central with respect to all these schémas through which - I would ask you to retain these formulae - the moment of the advance of jouissance, of the jouissance of the Other and towards the jouissance of the Other, involves the constitution of castration as a pledge of this encounter.

5)		<u>o</u>	desire of 0
4)	image	power of 0	
3)	desire	anxiety -φ	<u>jouissance</u> of 0
2)	trace	demand of 0	
1)	anxiety	<u>o</u>	desire x of 0

The fact that male desire encounters its own collapse before the entry into the jouissance of the feminine partner, just as, as one might say the jouissance of the woman is crushed (s'ecra.se) - to take up a term borrowed from the phenomenology of the breast and of the nursing - is crushed in phallic nostalgia and henceforth is required, I would say almost condemned to only love the male other at a point situated beyond the one at which, she also, stops him as desire: this beyond is aimed at in love; it is a beyond - let us say it clearly - either transverberated by castration, or transfigured in terms of potency. It is not the other as if it were a matter of being united to the other. The jouissance of the woman is in herself and is not connected to the Other. If I recall in this way the central function - let us say as obstacle, it is not at all an obstacle, it is the locus of anxiety - of what one might call the caducity of the organ, in so far as it encounters in a different fashion from each side what one can call the insatiability of desire, it is because it is only through this reminder that we see the necessity of symbolisations which in this connection display themselves with a hysterical aspect or an obsessional aspect.

Today we are on the second of these aspects. And what the second of these aspects reminds us of, is that simply by reason of the structure evoked, man is only in woman through the delegation of his presence under the form of this .decayed organ, of this organ of which he is fundamentally, in the sexual relationship and through the sexual relationship, castrated.

This means that the metaphors of gift here are only metaphors. And as is only too obvious, he gives nothing. The woman neither.

(13) And nevertheless the symbol of the gift is essential for the relationship to the Other; it is the supreme act, we are told, and even the total social act. It is here indeed that our experience has made us always put our finger on the fact that the metaphor of gift is borrowed from the anal sphere. For a long time it has been noted in the child that the turd, to begin to speak more politely, is the gift in essence, the gift of love. In this connection many other things have been picked out, up to and including, in a particular form of delinquency, in what is called, after the burglar has gone, the signature that every policeman and the books of legal medicine know well, this bizarre fact, but one which ended up all the same by being noticed, that the guy who has been using the jemmy in your house, and opening the drawers, always has at that moment an attack of colic. This obviously would allow us to find our bearings quickly at the level of what I called earlier manifest conditionings. It is at the level of mammals that we locate, at least in what we know about animal ecology, the function of the fecal trace, more exactly of faeces as trace, and a trace here also certainly profoundly linked to the essential nature of the place of what the organismic subject assures himself of at the same time in terms of possession, in the world, of territory and of security for sexual union.

You have seen described, in places which now all the same are sufficiently defused, this fact that these subjects, the hypopothamus certainly and even - this goes further than the mammals - the robin, feel themselves to be invincible within the limits of the territory and that all of a sudden there is a turning point: the limit precisely where curiously he becomes very timid.

The relationship, in mammals, between this limit and the fecal trace has been noticed for a long time. A reason once more to see there what prefigures, what prepares for this function of representing the subject, and finding there the roots in the biological background of the object *o* in so far as it is the anal fruit.

Are we still going to be satisfied with this? Is this all that we can draw from questioning the function of *o* in this relationship to a certain type of desire, that of the obsessional? This is where we take the next step which is also the essential step. We have justified nothing up to the present (14) other than the subject installed or not in his limits, and within these limits, more or less divided. But the access to the symbolic function that he takes on from the fact that these limits, are seen, at the level of sexual union in man, to be so singularly repressed, even this does not yet tell us anything about what is involved and what we are in the process of requiring, namely how all this whole process manages to justify the function of desire.

And it is experience which gives us the trace of this, namely that up to the present nothing explains to us the very particular relationships of the obsessional to his desire. It is precisely

because up to this level everything is symbolised, the divided subject and the impossible union, and it appears altogether striking to us that one thing is not, namely desire itself.

It is precisely in this effort, in this necessity that the subject finds himself of having to complete his position as desire, that he is going to complete himself in the category of potency, namely at the level of the fourth stage. The relationship between the specular reflection of the narcissistic support of the mastery of self and the field, the locus, of the Other, is the link here. You know it already and this would only be to make you retravel a well trodden path. This is why I want here to mark the originality - otherwise it would never have come to our knowledge - of our interrogation, the originality of what the facts reveal to us.

And to start from the heart of things, and from a fact that you know well, I would say without delaying any longer on the fact that I recalled a thousand times about what I called just now the relationships of the obsessional subject to his desire, namely that, as I told you the last time, the degree of luxuriance reached by his phantasies, which are ordinarily never carried out, but after all it can happen that through all sorts of conditions which postpone more or less indefinitely the putting into action, he gets there, he gets there better, it even happens that others overcome for him the space of the obstacle, a subject who develops very early as a magnificent obsessional may happen to be in a family of dissolute people. Case II in Volume 5 of the Jahrbuch, to which I alluded earlier, on which Jones based himself for his phenomenology of the anal function in the obsessional, Case II - and I could quote a thousand others in the literature - is one of those.

All the sisters - and they are numerous - without counting the mother, the aunt, the mother's different lovers, and even I believe - God forgive me - the grandmother - all had taken turns (15) on the belly of this little kid when he was about five years old. He is nevertheless an obsessional, an established obsessional, with desires of the only kind that he can manage to constitute in the register of potency: impossible desires, in this sense that whatever he does to realise them, he is not in them. The obsessional is never, at the end of his search for satisfaction, in these registers. So then the question that I am posing you, is just as living and brilliant in this observation as in many others, it is in a form that I called just now living and brilliant - it is the image of a little fish that is evoked here, and I can say, under my hand, and with good reason - this ictus, as you see it everywhere in the field of the obsessional, provided he is from our cultural space - and we do not know any different one - this ictus, is Jesus Christ himself. One might speculate a good deal about what kind of blasphematory necessity - I must say that up to the present it has never been properly justified as such - why is it that such a subject, like many other obsessionals cannot carry out one or other of these more or less atypical acts in which his sexual research spends itself, without immediately phantasising Christ as associated in

it. Even though the fact may have been present to our eyes for a long time, I do not think the last word has been said about it. It is quite clear first of all that Christ on this occasion - and this is why it is a blasphemy - Christ is a God. He is a God for many people, and even for so many people that in truth it is very-difficult even with all the manipulations of historical and psychological criticism, to dislodge him from this place.

But after all he is not just any God.

You will allow me to doubt that obsessionals at the time of Theophrastes, the one who wrote the Characters, amused themselves by mentally making Apollo participate in their base deeds.

Here we can see the importance of the little mark in passing, the beginning of an explanation that I thought it worthwhile giving in passing that the God, whether we like it or not, and even if we no longer have with the God or the Gods - for they are rather plural than singular - any relationship, this God is an element of the real. So that they are always there, it is quite clear that they walk around incognito. But there is one thing that is very certain: it is that the relationship of the God is very different from ours to the object of his desire.

(16) I spoke a little earlier about Apollo. Apollo is not castrated either before or afterwards. Afterwards something else happens him. We are told that it is Daphne who was transformed into a tree. It is here that something is hidden from you. And it is hidden from you, it is very astonishing because it is not hidden from you. The laurel tree, after the transformation, is not Daphne, it is Apollo. The proper of the God is that he is transformed, once he is satisfied, into the object of his desire, even if by that he becomes petrified in it.

In other words, a God, if he is real, gives here the image of his power. His power is there where it is. It is true of all the Gods, even of Elohim, even of Yahwea, who is one of them, even though his place is quite particular. Only something intervened there which has a different origin. Let us call it, on this occasion and because it is historically true - but no doubt this historical truth has to go a step beyond - let us call him Plato.

He told us things which, as you have seen, remain very manageable within the ethics of jouissance, because they have allowed us to trace the border of entry, the barrier that the Beautiful constitutes with respect to this supreme Good. Only, mixed in with a Christianity that was coming to birth, that gave something, something people believe was always there, and always in the Bible, but we will have to return to it no doubt later, if we are all still here next year. The matter is debatable, the matter that I am going to tell you about, namely the phantasy of an omnipotent God, which means of a God who is powerful everywhere at the same time, and of a God who is powerful for everyone; for it is indeed to that that one is forced to come, if the world is as it is, it is clear that the power of God is exercised at the same time in every direction.

Now the correlation between this omnipotence and something which is, as I might say all seeingness, sufficiently signals here to us what is involved. It involves something which is outlined in the field beyond the mirage of power, of this projection of the subject into the field of the ideal, reduplicated between the specular alter-ego, the ideal ego, and this something beyond which is the ego-ideal.

The ego-ideal, when at this level what it is a matter of covering over, is anxiety, takes the omnipotent form. The phantasy of ubiquity in the obsessional, the phantasy which is also the support on which there come and go the multiplicity of his desires, which are always to be rejected further away, it is (17) there that he seeks and finds the complement of what is necessary for him to constitute himself in desire.

From this it results - I will only quote here for you the little corollaries that can be drawn from this - that a question which was raised in what I could call the heated circles of analysis, the ones in which there still lives the movement of a primary inspiration, namely whether the analyst ought or ought not to be an atheist and if the subject, at the end of analysis, can consider his analyst terminated if he still believes in God.

It is the question that I am not going to treat today, I mean to settle. But on the road of such a question, I point out to you that whatever an obsessional testifies to you in his remarks, if he has not been routed out of his obsessional structure, you can be quite persuaded that qua obsessional he still believes in God, I mean that he believes in the God that everybody or almost everybody in our cultural arena, I mean in the God that everybody believes in without believing in him, namely this universal eye that is brought to bear on all our actions.

Here this dimension is as solid in its frame as the window of the phantasy that I spoke about the other day. Simply it is also required by it, I mean, even for the greatest believers that they do not believe in it. First of all because if they believed in it, it would be seen. And because if they are as believing as all that, one would notice the consequences of this belief, which in fact remains strictly invisible in events.

Such is the veritable dimension of atheism: the one which is supposed to have succeeded in eliminating the phantasy of the Omnipotent. Well then, a gentleman called Voltaire and who all the same knew something about anti-religious criticism, held very strongly to his deism, which means to the existence of the Almighty, and thought that Diderot was mad because he found that inconsistent. It is not sure that Diderot was really an atheist; to me his work seems rather to bear witness to it, given the way in which he brought into operation the intersubjective at the level of the Other in his major dialogues, Le neveu de Rameau and Jacques le Fataliste. He is only able to do it nevertheless in the style of derision.

The existence therefore of the atheist in the true sense can only

be conceived of in effect at the limit of an ascesis, which indeed appears to us can only be a psychoanalytic ascesis, I mean (18) of an atheism conceived of as a negation of this dimension of presence, at the basis of the world of omnipotence. This does not mean that the term atheism and the existence of the atheist does not have its historical correspondent. But it is of a quite different nature. Its affirmation is directed precisely towards the side of the existence of gods qua real. It neither denies it nor affirms it, it is directed at that. The atheist of the tragedy L'athee - I am alluding to Elizabethan tragedy - the atheist gjxa combatant, qua revolutionary, is not the one who denies God in his omnipotent function, it is the one who affirms himself as not serving any God.

And this is the dramatic, essential value, the one which always gives its passion to the question of atheism. I apologise for this little digression, which, as you may well imagine, is only preparatory.

You see where our little circuit today has led us: to the fundamental liaison between these two stages framing the fundamental impossibility, the one which divides at the sexual level, desire and jouissance. The style of detour, the style of encompassing, the impossible foundation that the obsessional gives to his desire, has allowed us, in the course of our analysis today, to see there being outlined something, namely that this link to a lost object of the most disgusting type, shows its necessary liaison, there in effect with the highest idealistic production. This circuit is nevertheless not yet completed. We see clearly how desire is appended to this structure of the object. It still remains for us - this is what we will articulate the next time - to highlight what this median table which, I hope, you have all copied, indicates to you as being our next field, to highlight the relationship between the obsessional phantasy, posed as a structure of his desire, and the anxiety which determines it.

Seminar 24: Wednesday 26 June 1963

In order to advance today in our account, I am going to take up the things that concern the constitution of desire in the obsessional and its relation to anxiety. And to do it, I am going to return to a sort of table, of matrix, of double entry table that I gave you during the very first lectures of this year's Seminar in the form reproduced here, bracketed by the white line and written in pink.

<u>Inhibition</u>	Impediment	Embarrassment
Emotion	<u>Symptom</u>	Passage à l'acte
Dismay	Acting-out	<u>Anxiety</u>

The intention of this table then was to mark the sort of derangement, of staggering represented by the three terms which Freud came to and which he inscribed in the title of his article Inhibitions, symptoms and anxiety. Around these three terms, I punctuated something that we can designate as moments, as a certain number of definable moments in the terms which are here inscribed in this table, and which have as a characteristic, for each term, of referring to the start of its column above, to the start of the row on the left. You find there a correlation which can, when put to the test, be proposed for interrogation as suitable for being confirmed or disproved in its structural function.

Again these terms were presented to you at that time in a certain incompleteness, involving therefore some suspensions, riddles; specifically, the distinction for example between "emotion" and "dismay" may have been, despite the etymological references that I made at the time, may have been all the same for you a matter of interrogation which it was not entirely possible for you to resolve with your own resources.

Assuredly, what I will contribute today seems to me to be of a nature to bring you specifications -which, I have no doubt, for most of you, if not for all, can only be new or even unexpected. And in particular, to begin with this dismay, whose origin, quite distinct from that of the term emotion, is not "motion outwards, motion hors", movement outside the organised, adapted field for

example of motor action, as undoubtedly emotion etymologically, - I am not saying that this is something that we can entirely trust - as emotion etymologically indicates and refers to, dismay is to be sought quite elsewhere if it is to be understood; and etymologically - it was the indication that I gave you for it - the etymology in esmayer referring to a German root, to mogen, a quite primitive Germanic root, gives the indication of something (2) which posits the principle of power as outside - outside of what?

A riddle therefore, around something which is not unrelated to power, and I would say that perhaps even, to take the form that it has taken in French, that it is something of the order of "outside me, hors de moi", "outside oneself, hors de soi" that, in an approach which - here it is almost necessary to refer to the pun - is no less important, we have to direct our minds, to see clearly, to glimpse at least, the direction in which we are going to go today.

To go immediately to the heart of things - it is because the obsessional illustrates it by his phenomenology immediately and in a very tangible way - I would say that at the point that we are at I can tell you very crudely, straight out, that dismay, the that is involved, is nothing other, at least in the correlations that we are trying to explore, to specify, to disentangle, to create today, namely the relations between desire and anxiety, dismay in this correlation is nothing other than the o itself.

In the conjuncture between anxiety and its strange ambiguity, I taught you to circumscribe in the closest possible way throughout the discourse of this year, the ambiguity which allows us for our part, after this elaboration, to formulate what is striking in its phenomenology, what we can preserve of it, and what authors from elsewhere make slips and errors about, and what we introduce a distinction into, this characteristic of being without cause, but not without object; this is a distinction on which I base my efforts. To situate it, I have directed you: not alone is it without object, but it designates very probably what I might call the most profound object, the final object, the Thing. It is in this sense that I taught you to say that it is what does not deceive.

This "without cause", so obvious on the contrary in its phenomenon, is something which is better illuminated to our view by the way in which I tried to situate for you where the notion of cause begins.

This reference to dismay is henceforth that through which anxiety, while being linked to it, does not depend on it, but on the contrary determines this dismay. Anxiety finds itself suspended between what one might call the prior form of the relationship to the cause, the "what is it?" which is going to be formulated as cause, embarrassment, and something which cannot (3) hold onto this cause, since primarily it is anxiety which literally produces this cause.

Something happens which illustrates in an abject and thus all the more striking fashion what I put at the origin of my explanation of the obsessional in the confrontation of the Wolfman and his major repetitive dream, in the anxiety-provoking confrontation with something which appears as a showing forth of his final reality, this thing which is produced, which never reaches his consciousness, but can only be in a way reconstructed as a link for the whole subsequent determination, anal dismay to call it by its name and its product, here at the level of the obsessional is the primary form in which there intervenes the emergence of the object o which is at the origin of everything that is going to flow from it in the mode of effect.

It is because here the object o is found to be given in an original moment in which it plays a certain function on which we are now going to try to dwell in order to specify carefully its value, its incidence, its import, its primary coordinates, the ones before the others are added on, it is because the o is that in its original production that it can subsequently function in the dialectic of desire which is that of the obsessional.

A coordinate therefore, at the moment of its apparition, of this at the traumatic unveiling, where anxiety reveals that it is indeed what does not deceive at the moment that the field of the Other, as one might say, is rent and opens out onto its foundations, what is it, this o, what is its function with respect to the subject?

If we can grasp it here in a way in a pure fashion with respect to this question, it is precisely in the measure that in this radical, traumatic, confrontation the subject cedes (cede) to the situation. But at this level, at this moment, what does this "yields" mean, how is it to be understood? It is not that he either vacillates or weakens, as you know well. Remember the attitude schematised by the fascination of this subject of the dream of the Wolfman before the window opening onto the tree covered with wolves. In a situation whose immobilisation suspends before our eyes its primitively inarticulatable character and by which nevertheless he will remain marked forever, what was produced is literally something which gives its true sense to this "yields" of the subject, it is literally a ceding (cession).

(4) This characteristic of cedable object (objet cessible) is one of the characteristics of o which is so important that I would ask you please to follow me in a brief review to see whether it is a characteristic which marks all the forms of o that we have enumerated. It here appears to us that the fixation points of the libido are always around one of these moments which nature presents for this eventual structure of subjective ceding.

The first moment of anxiety, the one that analytic experience got closer to bit by bit, let us say at the level, around the trauma of birth, henceforth, with this remark, allows us to accentuate it as something more precise, more precisely articulatable than what was first of all roughly approached in the form of

frustration and to ask ourselves, and to notice, after we have asked ourselves, that the most decisive moment in the anxiety-involved, the weaning anxiety, is not so much that on a particular occasion the breast is missing when he needs it, it is rather that this little child cedes this breast which, when he is appended to it, is indeed like a part of himself.

Let us never forget, what I put to you - and I am not the only one to have noticed it, I refer specifically here to Bergler - that the breast forms part of the individual at the nursing stage, that he does not find himself, as I told you in a vivid expression, except as stuck onto his mother. That he is able in a way to hold onto this breast or let it go, is where there is produced the most primal moment of surprise, sometimes really graspable in the expression of the newborn, on which for the first time there passes the reflection of something related to this abandonment of this organ which is much more the subject himself, than something which is already an object, something which gives its support, its root, to what in another register was perceived, called, as regards the subject, dereliction.

But for that matter for us, as for all the other objects o, do we have any other manifest control than this emphasis I give to the possibility of replacing the natural object by a mechanical object, if I can express myself in that way? What I am designating here, is first of all the possible replacement of this object by any other object which may be encountered, another partner, the nurse who gave rise to so many questions for the first proponents of natural education, for the Rousseau-style theme of feeding by the mother, but beyond it to this something (5) which, God knows, did not always exist - at least so we imagine - and which cultural progress has manufactured, has constituted, the soother, namely the possibility of putting o in reserve, in stock, in circulation in the shops and moreover to isolate it in sterile tubes.

This characteristic therefore of ceding the object is expressed by the appearance in the chain, the function of human manufacture, the appearance of cedable objects (objets cessibles) which are, which can be, their equivalents. And if this reminder is not out of season here, it is because from this angle I intend to attach to it here the function on which I have laid stress for a long time, that of the transitional object, to take the term, whether it is correct or not, but henceforth consecrated, with which it was pinpointed by its creator, the person who spotted it, namely Winnicott.

Here, in effect, at this level, one sees clearly what constitutes this object that he calls transitional, in this function of the object that I call a cedable object: it is a little piece, torn from something, most often a piece of cloth, and one clearly sees what is involved as regards the relationship of the subject to the support that he finds in this object. He is not dissolved in it, he is comforted by it, he is comforted by it in his quite original function as subject, from this position of collapse, as I might say, with respect to the signifying confrontation. Here

we have, not an investment of o, but what I might call an investiture. Here, it is the substitute (suppleant) for the subject, and substitute in position, in a way, preceded, it is this relationship o with respect to something which secondarily reappears after this disappearance. This primitive mythical subject who is posed at the beginning as having to constitute himself in the confrontation, but that we never grasp - and for good reason - that it is because the o has preceded him, and because it is in a way itself marked by this primitive substitution, that it has to re-emerge beyond.

This function of the cedable object as a separable fragment, carrying in a way primitively something of the identity of the body which antecedes the body itself as regards the constitution of the subject, since I spoke about a manifestation in the history o^ human production which can in a way for us have the value of confirmation, of revelation, in this sense I cannot possibly not evoke now, at the extreme term of this historical evolution, or more exactly of this manifestation in history of problems which are going to pose us, I am saying, at what one could call the most radical essentiality of the subject, the (6) probably immense extension already engaged in more than, I would say, common consciousness - and even that of practitioners like ourselves - may be aware of, the questions going to be posed by the fact of organ transplants, which take on an appearance which in undoubtedly surprising and well designed to suspend the mind around some question or other: how far should we, or how far are we going to, consent to it? Just how far will go the fact which is opened out here, with what I would call the mine, the mainspring, the principle of these astonishing possibilities, is perhaps going to be found soon in the artificial maintenance of certain subjects in a state, which we cannot, which we will no longer be able to say is one of life or of death, since as you know Angstrom's methods allow us to make subsist in a living state the tissues of subjects in whom everything indicates that the functioning of their central nervous system cannot be restored, no brain waves, mydriasis, .unrecoverable absence of reflexes? What is involved, what do we do when it is from a subject in this state that we borrow an organ? Do you not sense that there is here an emergence into the real, of something of a kind to reawaken, in altogether new terms, the question of the essentiality of the person, and of what it is attached to, to beg these doctrinal authorities who can on occasion provide material for juridicism, to earnestly request them to see how far, in practice this time, the question of whether the subject is a soul or indeed a body can be taken?

I will not go any further along this path today because as a matter of fact these doctrinal authorities seem already to have evoked quite singular responses that it would be well to study very closely in order to see their, consistency with respect to certain positions which have been taken for a long time, and where for example there is radically distinguished, on the very plane of the relationship, of the identification of the person with something immortal which is supposed to be called the soul, a doctrine which articulates in its principles something that is

the contrary of the Platonic tradition, namely that there can be no resurrection other than that of the body.

Moreover the domain evoked here is not so linked to this industrial advance in singular possibilities, for it not to have been evoked for a long time in visionary fabulations, and here I have only to refer you once more to the Unheimlich function of (7) the eyes in so far as to manipulate, to make a living being change into his automaton, the character incarnated by Hoffmann is put at the centre, by Freud, of his article on the Unheimlich, this Coppélius, the one who hollows out eye sockets, who is going to seek down to their root what is somewhere the capital, essential object to present itself as the beyond - and the most anxiety-provoking - of the desire which constitutes it, the eye itself.

I said enough in passing about the same function of the voice and the way in which it appears to us, will appear to us no doubt with so many technical improvements, to be all the more able to be here of the order of these cedable objects, of these objects which can be placed on the shelves of a library, in the form of disks or of tapes, and regarding which in this case we only need to evoke one or other old or new episode, to know the singular relationship it can have with the arousal of a particular conjuncture of anxiety. Simply, let us add to it properly speaking the following, at the moment that there emerges in a cultural area in which it arises for the first time, the possibility also of the image, I mean of the specular image, of the image of the body, in a detached state, in a cedable state, in the form of photographs or even of drawings, and of the lure, of the repugnance that this provokes in the sensibility of those who see it emerging suddenly in this form, at once indefinitely multipliar>le and able to be distributed everywhere, the repugnance, indeed the horror that these cultural things in areas that there is no reason for us to call primitive, the apparition of this possibility gives rise to, with the refusal to allow these images to be taken since God alone knows, it must be said, where they may go afterwards.

It is in this function, in this function of cedable object and in short the most natural one, whose naturalness can only be explained from having taken on this function, that the anal object intervenes in the function of desire, that here, it is here that we have to grasp the way in which it intervenes, and to put to the test, not forget the guidance that our formula gives us, that this object is then, not the end, the goal of desire but its cause, the cause of desire in so far as it is itself something non-effective, that it is this sort of effect founded, constituted on the function of lack, which only appears as effect where in effect there is situated alone the notion of cause, namely at the level of the signifying chain where this desire is what gives it this sort of consistency in which the subject is constituted essentially as metonymy. But how are we going to (8) qualify this desire here, at the level of the constitution of the subject, where we grasp it in its incidence, in the constitution of the subject? It is not the contingent fact, the

facticity of education in cleanliness which gives it this function of retaining, which gives its fundamental structure to anal desire. It is a more general form that is involved here and that we must grasp in this desire to retain.

In its polar relationship to anxiety, desire is to be situated there where I put it for you, corresponding with this old matrix, at the level of inhibition. This is why desire - as we know - can take on the function of what is called a defence. But let us go step by step to see how this happens eventually. What is inhibition? For us, in our experience, it is not enough for us to have this experience and for us to manipulate it as such for us yet to have correctly articulated its function, and this is what we are going to try to do. What is inhibition if not the introduction into a function - perhaps not an indifferent one; in his article, Freud takes as support, for example, the motor function - the introduction of what? Of a different desire to the one that the function satisfies naturally.

This after all we know, and I am not claiming here to discover anything new; but I believe that in articulating it in this way, I am introducing a new formulation, the deductions flowing from which escape us without this very formulation.

For this locus of inhibition where we learn to recognise, while I am underlining it, the correlations this matrix indicates, the locus properly speaking where desire is exercised, and where we grasp one of the roots of what analysis designates as Urverdrangung, what I might call this structural occultation of desire behind inhibition - it is something which makes us say habitually that if Mr So-and-so has writer's cramp, it is because he eroticises the function of his hand, I think this is familiar to everybody - it is this which urges us to bring into play, to appreciate in this situation at the same place these three terms, the first two of which I have already named: "inhibition", "desire", the third being the act. For when it is a question for us of defining what the act is, the only possible, polar correlative in the place of anxiety, we can only do it by situating it there where it is: at the place of inhibition in (9) this matrix.

The act cannot be defined for us, or for anybody else, as something which only happens as I might say, in the real field, in the sense that movement, the motor effect, it will be said, defines it, but as something which in this field - and no doubt in the form of movement on occasion, but not only that - whatever share there may still remain there of a motor effect which is expressed in this field, the field of the real in which the movement response is exercised, which is expressed in such a way that there is expressed in it another field, which is not simply the one of sensory stimulation for example, as it is articulated by considering only the reflex arc, which is not to be articulated either as a realisation of the subject.

This is the conception of the personalist myth in so far precisely as it eludes, in this field of the realisation of the

subject, the priority of o which inaugurates and henceforth preserves this privilege in the field of the realisation of the subject, of the subject as such who is only realised in the objects which belong to the same series, which are from the same place, let us say, in this matrix, as the function o, which are always cedable objects: and these are what for a long time have been called "works" with all the meaning that this term has even in the field of moral theology.

So then what happens in the act of this other field which I am speaking about, and whose incidence, agency, insistence in the real is what connotes an action as act? How are we going to define it? Is it simply this polar relationship and in a way what happens in it in terms of overcoming anxiety, if I can express myself in this way?

Let us say, in formulae which can only approach after all what an act is, that we speak about act when an action has the character, let us say, of a signifying manifestation in which there is inscribed what can be called the the gap (l'ecart) of desire. An act is an action, let us say, in so far as there is manifested in it the very desire which is supposed to have been designed to inhibit it. It is in this foundation of the notion, of the function of the act in its relationship to inhibition, and there alone, that one can be justified in calling "act" things which in principle appear to be so little related to what one could call, in the full, ethical, sense of the word an act: a sexual act on one hand and on the other a testamentary act.

Well then, it is here in this relationship of o to the constitution of a desire - and what it reveals to us about the relationship of desire to the natural function - that our (10) obsessional has for us his most exemplary value. In his case we put our finger all the time on this characteristic, whose enigmatic aspect can be effaced for us only out of habit, that in his case desires manifest themselves always in this dimension that I went so far as to call earlier, anticipating a little no doubt, the function of defence.

How can this be conceived of simply, on what basis does this incidence of desire in inhibition deserve to be called defence? It is because, as I told you, that - it was in an anticipatory fashion that I was able to speak about defence as an essential function of the incidence of desire - it is uniquely in so far as this effect of desire, signalled in this way by inhibition, can be introduced into an action already caught up in the induction of another desire - this is also for us a common fact of experience - and after all, without mentioning the fact that we are always dealing with something of this order, let us observe that, not to leave our obsessional, this is already the position of anal desire, defined in this way, by the desire to retain centred on a primordial object, to which it is going to give its value, it is already here that there is situated the desire that is situated as anal. It has no meaning for us except in the economy of the libido, namely in its liaisons with sexual desire.

It is fitting to recall here that in the inter urinas et faeces nascimur of St. Augustine, the important thing is not so much that we are born between urine and faeces, at least for us analysts, it is that we make love between urine and faeces. We piss before and we shit afterwards or inversely.

And this is one of the further correlations and one to which we give too little attention as regards a phenomenology that after all we allow to come into analysis. That is why it is necessary to have one's ear pricked, and to pick out in the cases in which this emerges, the relationship which links to the sexual act the fomenting, as I might say, of that which will appear of course as unnoticed, as perhaps unevoked, in the history of the Wolfman, his primal little present, the habitual fomenting, in the sexual act, of something which of course does not seem to be very important, but which takes importance from being indicative of the relationship I am speaking about, the fomenting of the little shit, whose subsequent evacuation has no doubt not the same signification for every subject, depending on whether for example (11) they are on the obsessional slope or on another one.

So then let us take up our path at the point that I left you on it, namely: what about the point that I am now directing you towards, as regards this underlay of desire in desire, and how to conceive here what in this path leads us towards the elucidation of its meaning, leads us to it I mean not simply in fact, but of necessity? Are we going to be able to conceive in this interpretation of desire/defense and what it is defending against, namely another desire, that we are simply led, as I might say, quite naturally by what leads the obsessional in a movement of recurrence of the process of desire generated by this implicit effort of subjectivication which is already in his symptoms in which he tends to lay hold of its stages again, in so far as he has symptoms, and what is meant by the correlation inscribed here in the matrix, with impediment, with emotion? This is what the titles that I put in its reduplication explained here underneath, designate for you.

Desire	Not to be able	Cause
Not to know		
<u>o</u>		Anxiety

What is the impediment that is involved? It is that something intervenes, the impediment: "impedicare", caught in the trap, which is not the reduplication of inhibition. A term had to be chosen. The fact is that the subject is quite impeded in retaining his desire to retain, and that, in the case of the obsessional this is what manifests itself as compulsion.

The dimension of emotion here, borrowed from a psychology which is not our own, a psychology of adaptation, of the catastrophic reaction, also intervenes here in a quite different sense to this

classic and habitual definition. The emotion involved is the one which is supposed to highlight the experiences based on being confronted with a task, namely that the fact that the subject does not know how to respond, is where he connects up with our "not to know, ne pas savoir", : he did not know that it was that and that is why at the level of the point where he cannot stop himself (s 'empe~cher) that he allows things to happen, which are these comings and goings of the signifier, that alternately posit and efface, which all go along this equally unknown path of rediscovering the primal trace; what the obsessional subject seeks in what I called earlier - and you will see why the choice of this word - its recurrence in the process of desire, is well and truly to rediscover the authentic cause of this whole process. And it is because this cause is nothing other than this final, abject and derisory object, that he remains in suspense in this search, that there is always manifested there, at the level of acting-out, something that is going to give to this search for the object its moments of suspension, its wrong directions, its mistaken paths, its lateral divergences which will make the search turn indefinitely, and which are manifested in this fundamental symptom of doubt which for him is going to affect the value of all his objects of substitution.

Here not to be able - is not to be able to what? - to stop oneself (s'empecher). The compulsion here, the doubt, concerns precisely these doubtful objects thanks to which there is pushed back the moment of access to the final object which would be the end, in the full sense of the term, namely the loss of the subject on the path where he is always exposed to entering along the path of embarrassment, of embarrassment where there is introduced as such the question of the cause, which is that through which he enters into transference.

What should retain us here? Have we seen, circumscribed, even approached, the question I posed about the incidence of another desire which with respect to this one whose path I have travelled along, might play the role of defence? Manifestly not. I traced the path of the return to the final object with its correlation of anxiety; for it is here there lies the motive for the growing arousal of anxiety. And in the measure that the analysis of an obsessional is pushed further towards its term, provided only it is guided along this path, the question then remains open, if not of what I meant - for I think that you have already glimpsed that - but about what the incidence as defence is, a defence no doubt working and working very hard to put off the expiry date (echeance) that I have just outlined, as defence of another desire.

How is this possible? We cannot conceive of it except by giving its central position, which is something I already did earlier, to sexual desire, I mean to the desire that is called genital, to natural desire in so far as in the case of man, and precisely in function of this structuring proper to desire around the mediation of an object, it posits itself as having anxiety at its heart and separating desire from jouissance.

This function of o which at this level of genital desire is symbolised analogically by the dominance, by the pregnancy of o in the economy of desire, is symbolised at the level of genital desire by the (-tí>) which appears here as the subjective residue at the level of copulation, in other words, which shows us that the copula is everywhere, and that it only unites by being lacking there where precisely it would be properly copulatory.

(13) It is to this central hole which gives its privileged value to castration anxiety, namely to the only level at which anxiety is produced at the very locus of the lack of the object, it is to this that, specifically in the obsessional, the coming into play of another desire is due. This other desire, as I might say, gives its foundation to what can be called the eccentric position, the one that I have been trying to describe for you, of the desire of the obsessional with respect to genital desire.

For the desire of the obsessional is not conceivable either in its agency or in its mechanism, except in so far as it is situated as a substitute for what it is impossible to supply elsewhere, namely at its place. In a word, the obsessional, like every neurotic, has already acceded to the phallic stage, but it is with respect to the impossibility of being satisfied at the level of this stage, that his own object, the excremental o, the o cause of desire to retain, and which, if I really wished to conjoin here its function with everything that I said about the relations to inhibition, I would rather call the cork, it is with respect to it that this object is going to take on what I could call developed values. And it is here that we cut through to the origin of what I could call the analytic phantasy about oblativity. I already said and repeated, that it is an obsessional phantasy. For of course everyone would love to think that genital union is a gift: I give myself, you give yourself, we give ourselves. Unfortunately there is no trace of gift in a genital copulatory act, however successful you may imagine it to be. There is only a gift precisely where it has always been well and truly and perfectly located: at the anal level, in the measure that here something is outlined, emerges, of what is here precisely at this level designed to satisfy, to bring the subject to a halt with the realisation of the gap, of the central hole, which at the genital level prevents anything whatsoever which might function as object of gift from being grasped.

Since I spoke about a cork, by which you can recognise that it is the most primitive form of what I called, of what I introduced the other day to you as the exemplary object that I called the tap through the discussion of the function of the cause, well then how could we illustrate, with respect to what determines the function of the object stopper or tap with its consequence, the desire to close, how could there be situated the different elements of our matrix?

(14) The relationship to the cause - what is that? What can one do with a tap? It is the initial point at which there comes into play from observation, in the experience of the child, this attraction that we see, contrary to any other little animal

whatsoever, manifesting itself for something which announces itself as representing this fundamental type of object.

The "not to be able" to make something of it, as well as the "not to know", and in their distinction there is indicated here sufficiently what the symptom is: it is a leak (fuite) in the tap. The passage a l'acte is to open it, but opening it without knowing what one is doing. This is what is characteristic of the passage a l'acte. Something happens by which a cause is liberated, by means which have nothing to do with this cause. For, as I pointed out to you, the tap only plays its function of cause in so far as everything that can come out of it comes from elsewhere. It is because there is the appeal of the genital, with its phallic hole at the centre, that everything that can happen at the level of the anal comes into play because it takes on its meaning.

As regards acting-out, if we wish to situate it with respect to the metaphor of the tap, it is not the fact of opening the tap as the child does, without knowing what he is doing, it is simply the presence or not of the jet of water. Acting-out, is the jet, namely what is always produced from an event which comes from somewhere other than the cause that one has just acted on. And this is something that our experience indicates to us. It is not the fact that our intervention, let us say, for example on the plane of an anal interpretation is false which provokes the acting-out, it is that where it is brought to bear, it leaves room for something which comes from elsewhere. In other words: one must not inconsiderately pester the cause of desire.

Here therefore there is introduced the possibility of the function which on this terrain where there is played out the destiny of the desire of the obsessional, of his symptoms and of his sublimations, of something that will take on its meaning from being that which skirts around, as I might say, the central gap of phallic desire, what is happening at the scopic level, in so far as the specular image enters into an "analogous" function because it is in a correlative position with respect to the phallic stage.

Everything that we have just said about the function of o as "analogous" object of gift, designed to hold back the subject on the edge of the castrating hole, everything that we have just said about it, we can transpose onto the image. And here there (15) intervenes this ambiguity in the obsessional subject about the function of love which is underlined in all the observations. What is this idealised love that we find as much in the Ratman and the Wolfman as in every observation of an obsessional that has been taken a certain distance, what is the enigma of this function, given to the other - to the woman in this case - of this exalted object as regards which people have certainly not had to wait for either you or me or the teaching given here, to know that it represents surreptitiously the negation of his desire? In any case women for their part are not deceived by it.

What would distinguish this type of love from an eroto-maniacal

love, if we did not seek out what the obsessional engages of himself in love?

Do you believe that for the obsessional, if this is indeed the way things are as regards the final object that may be revealed in his analysis, along a certain recurrent path - I told you which one - excrement is the divinatory source for finding oneself to be a loveable object!

I would beg you to try to illuminate with your pocket torch what the position of the obsessional is in this regard. It is not doubt which prevails here, it is that he prefers not even to look at it. This prudence is something you will always find. And nevertheless if love takes on for him these forms of an exalted bond, it is because what he intends should be loved, is a certain image of himself, that this image he gives to the other, and to such an extent that he imagines that if this image were faulty in any way, the other would no longer know what to hold onto. It is the foundation of what I called elsewhere the altruistic dimension of this mythical love founded on a mythical oblativity.

But the maintenance of this image is what attaches him to a whole distance from himself which is precisely what it is most difficult to reduce, and which gave the illusion to a particular person, (Bouvet), who had, of course, a good deal of experience of these subjects, but not the apparatus - and for reasons which remain to be explored - to formulate it, to put such an accent on this notion of distance: the distance involved is this distance of the subject from himself with respect to which everything that he does is never anything for him in the final term - and, without analysis, is left to its solitude - but something that he sees as a game, when all is said and done, which only profited this other of whom I am speaking, this image.

(16) This dimension is the one that is usually highlighted, as regards the narcissistic dimension in which there develops everything that in the case of the obsessional is not so much central, namely symptomatic, but if you wish behavioural or experienced and which gives its veritable foundation, that through which what is involved for him, namely to realise at least the first phase of what is never permitted for him, what is never permitted to manifest itself in act, namely his desire, how this desire is sustained, as I might say, by doing the round of all the possibilities, at the phallic and genital level, which determine the impossible.

When I say that the obsessional sustains his desire as impossible, I mean that he sustains his desire at the level of the impossibilities of desire. The image of the hole, of the hole that is involved, I would ask you to find the reference to it - I told you about it once and that is why I insisted on it at such length - the reference to the topology of the torus, the circle of the obsessional is precisely one of these circles which because of its topological place can never be reduced to a point. It is because from the oral to the anal, from the anal to the phallic, from the phallic to the scopic and from the scopic to

the vociferous, it never turns back onto itself except by-passing again through its point of departure.

It is around these structures that the next time I will give its conclusive formulation to what this example, which is sufficiently demonstrative to be elaborated as an example, and is transposable moreover from these data into other structures, the hysteric specifically, that starting from this example, we are able in the final term to situate about the position and the function of anxiety.

Seminar 25: Wednesday 3 July 19 6 3

I will conclude today what I had set myself to say to you this year about anxiety. I will mark out its limit and its function, thus indicating where I intend there to continue the positions which alone allow us, will allow us settle, if it is possible, what is involved in our role as analysts.

Freud designated anxiety at the end of his work as a signal. He designated it as a signal distinct from the effect of the traumatic situation, an articulated signal of what he called danger; the word "danger" for him is linked to the function, to the notion, not elucidated it must be said, of "vital danger".

The original thing that I have articulated for you this year, is the specification of what this danger is. This danger is, in conformity with the Freudian indication, but more precisely articulated, what is linked to the ceding characteristic of the constitutive moment of the object o.

What, henceforth, for us, should anxiety be considered the signal of, at this point of our development? Here again we will articulate it differently to Freud: this moment, this moment of the function of anxiety is prior to this ceding of the object. For experience prohibits us from not, as the very necessity of his articulation obliges Freud, situating something more primal than the articulation of the situation of danger, once we define it as we have just done: at a level, at a moment prior to this ceding of the object.

Anxiety, I announced to you first in the Seminar of two years ago, anxiety manifests itself tangibly in a first approach as referring - and in a complex fashion - to the desire of the Other. From this first approach, I indicated that the anxiety-provoking function of the desire of the Other was linked to the fact that I do not know what object o I am for this desire.

I will emphasis today that this is only fully articulated, only takes on an exemplary form at what I called, designated here, in a sign on the blackboard, the fourth level definable as characteristic of the function of the constitution of the subject in his relation to the Other, in so far as we can articulate it as centered around the function of anxiety.

(2) There alone the specific plenitude by which human desire is function of the desire of the Other, there alone at this level is this form fulfilled. Anxiety, as I told you, is linked to the fact that I do not know what object o I am for the desire of the Other. But this when all is said and done is only linked to the level at which I can give this exemplary fable of it, in which the Other would be a radically Other, would be this praying mantis with a voracious desire, to which no common factor links me. On the contrary, something links me to the human Other which is my quality of being his fellow. What remains of the anxiety-provoking "I do not know" is fundamentally miscognition, miscognition at this special level of what is, in the economy of my desire as man, the o.

This is why, paradoxically, it is at what is described as the fourth level, at the level of scopic desire, that the structure of desire is for us most fully developed in its fundamental alienation, it is there also that the object o is most masked, and with it the subject is, as regards anxiety, most secured.

This is what makes it necessary for us to seek elsewhere than at this level the trace of o as regards the moment of its constitution. Since the Other, in effect, is in essence always there in its full reality, and therefore this reality, in so far as it takes on a subjective presence, can always manifest itself by one of its sharp edges, it is clear that development does not give an equal access to this reality of the Other.

At the first level, this reality of the Other is presentified, as is quite clear in the original impotence of the nurseling, through need. It is only in the second phase that with the demand of the Other something properly speaking detaches itself and allows us to articulate in a complete way the constitution of little o with respect to the function of the locus of the signifying chain, a function which I hear from the Other.

But I cannot today leave this first level without clearly highlighting that anxiety appears before any articulation as such of the demand of the Other. But, singularly, I would ask you for a moment to dwell on the paradox which connects the starting point of this first effect of ceding, which is anxiety, with what will be at the end something like its point of arrival: this manifestation of anxiety coinciding with the very emergence into the world of the one who will be the subject, is the scream, the scream whose function I have situated for a long time as not at (3) all an original but a terminal relationship to what we ought to consider as being the very heart of this other, in so far as he reaches completion for us at a moment as the neighbour.

This scream which escapes from the nurseling, he can do nothing about it. If he has ceded something here, nothing connects him to it. But this anxiety, this original anxiety, am I the first, have not all the authors emphasised its character in a certain traumatic relationship to the emergence of the organism - human on this occasion - into a certain world where it is going to live.

Can we not see certain contradictory features in these multiple and confusing indications? Can we retain as valid Ferenczi's indication that for ontogenesis itself, there is the emergence from some primitive aqueous milieu or other which is the homologue of the marine milieu, namely the relationship between the amniotic liquid and this water in which there can take place this exchange between the inside and the outside, which takes place in the animal living in such a milieu at the level of the brachiopoda, which is something that never functions at any moment of the human embryo. I would ask you rather to retain - for everything that is indicated to us in this often confused speculation which is psychoanalytic speculation ought to be considered by us as not without meaning, to be on the path of something indicative, that it skips over, delays on and sometimes illuminates, because phylogenesis is mentioned on occasion - I would ask you - from the point of view of a schematised exchange in the form of an organism with, at its border and on this border, a certain number of chosen points of exchange, to notice the degree to which in effect it is something unbelievable, if it is the case that the most basic schema of vital exchange is effectively created by the function of this wall, of this border, of this osmosis between an outside milieu and an inside milieu, between which there can be a common factor - to consider the strangeness of the leap by which living beings have emerged from their primitive milieu, have passed into the air therefore with an organ whose arbitrary character I would ask you to consult in the books on embryology, one cannot fail to be struck by what one might call the arbitrary character of the development of the neo-formation. There is just as much strangeness in this intrusion, inside the organism, of this system, in the whole adaptation of the nervous system to be accommodated for a long time before it really functions as a good pump, there is just as much strangeness in the leap constituted by the apparition of (4) this organ, as one might say there is in the fact that at a moment of human history, one saw human beings breathing in an iron lung, or again taking off into what is called inaccurately the cosmos, with something around them which for its vital function is not essentially different from what I am evoking here as a reserve of air.

Should we not recognise the essential feature of the fact that anxiety was in a way - it is Freud who indicates it to us here - chosen as a signal of something, this radical intrusion of something so other to the living human being which passing into the atmosphere already is; here we have the essential feature which means that the living human being who emerges into this world where he has to breathe, is first of all literally stifled, suffocated by what has been called the trauma - there is no other one - the trauma of birth, which is not the separation from the mother, but the aspiration into oneself of this fundamentally different milieu. Of course, the link between this moment and what can be called separation and weaning is not clear; but I question you, I ask you to gather the elements of your own experience, your experience as analysts, as observers of children, the experience also of everything that must be reconstructed, of everything that proves itself to be for us

necessary if we wish to give a sense to the term of weaning, to see that the relationship of weaning to this first moment is not a simple relationship, a relationship of phenomena which overlap, but much more rather some relationship of contemporaneity.

It is not essentially true that the child is weaned: he weans himself, he detaches himself from the breast, he plays, in accordance with this first experience, whose already subjectivised character is manifested just as tangibly by the passage on his face, simply outlining the first signs of mimicry, of surprise, he plays at detaching himself from this breast and taking it up again; and if there were not already something active enough for us to articulate it in the direction of a desire for weaning, how could we even conceive of the very primitive, the very primordial facts in their appearance, in their dating, the refusal of the breast, the first forms of anorexia, the correlations of which our experience teaches us to seek immediately at the level of the big Other.

What is lacking to this first object that we call the breast for it to function authentically as what it is supposed to be in the (5) classical theory, namely the rupture of the link with the Other, what is lacking is its full link to the Other, and this is why I strongly emphasised that its link is closer to the first little neo-natal subject, it is not of the Other, it is not the link to the Other that has to be broken, it is at the very most the first sign of this link. This is why it has a relationship with anxiety, but also why, from the first, it is in fact the first form of, and the form which makes possible, the function of the transitional object.

Moreover, it is not at this level the only object which offers itself to fulfill this function. And if later another object, the one on which the last time - one more again - I insisted at length, the anal object, comes to fulfill this function in a clearer fashion at the very moment that the Other elaborates her own in the shape of the demand - one can see the wisdom of the ages which ensures that these watchers over the coming into the world of the human animal, the midwives, have always dwelt on, have always been brought to a halt before this singular and so tiny object, the meconium, which comes with the appearance of the child - I will not return today, since I have already done it, to the much more characteristic articulation that this object, the anal object, allows us to give of the function of the object o, the object o in so far as it is found to be the first support of subjectivation in the relationship to the Other, I mean the way in which, or that through which, the subject is first required by the Other to manifest himself as subject, as a subject in the full sense of the term, as a subject who already here has to give what he is, in so far as this passage, this entrance into the world of what he is can only be as a remainder, as irreducible with respect to what is imposed on him in terms of a symbolic imprint.

What he is there, is what he has first of all to give; and it is to this object that there is appended, as to a causal object,

what is going to identify him primordially to the desire to retain. The first developmental form of desire is thus and as such akin to the order of inhibition. When desire appears for the first time, it opposes itself to the very act through which its originality as desire is introduced.

If it was already clear at the preceding stage that it is indeed to the object that there is appended the first form of desire, in so far as we elaborate it as desire for separation, for the second form, it is clear that the function of cause that I give (6) to the object is manifested in the fact that the form of desire is turned against the function which introduces the object o as such. For of course it must be seen that this object, as I recalled earlier, is here already given, already produced, and primitively produced, put at the disposition of this function that is determined by the introduction of the demand through something which is prior, that it was there already as a product of anxiety.

Here then it is neither the object in itself, nor the subject who autonomises himself, as it is imagined, in a vague and confused priority of totality which is involved here, but from the first initially an object chosen for its quality of being specially negotiable, of being originally an object of purchase (objet d'achat).

You see what is in question here: it is to realise that in this primal point of insertion of desire, which is linked to the conjunction within the same brackets of the o and of the D of demand, there is this on one side and on the other side anxiety, and it is in the interchanging of these positions of anxiety and of what has for the subject to be constituted in its function which will remain, up to the end, essentially represented by o, it is here that there is found the level at which we can, at which we must maintain ourselves, to sustain ourselves, if we wish to consider what is involved in our technical function.

This anxiety here, here it is then - we have known it for a long time - as it were set aside, dissimulated in this relationship of the obsessional that we call "ambivalent", this relationship that we simplify, that we abbreviate, that we even elude when we limit it to being one of aggressivity.

This object that he cannot prevent himself from retaining as the good which makes him worthwhile, and which is also only what is expelled, what is evacuated from himself, are the two aspects by which it determines the subject even as compulsion and as doubt. It is on this very oscillation between these two extreme points that there depends the passage, the momentary, possible passage of the subject through this zero point where it is, when all is said and done, entirely at the mercy of the other - here in the dual sense of the small other - that the subject finds himself.

And that is why, from my second lecture on, I pointed out to you, in opposing the structure of the relationship of desire to the desire of the Other, in the sense that I teach you it, to the

structure in which it is articulated, defined, algebrised in the Hegelian dialectic, and that I told you that the point at which they overlap, a partial point, the very one which allows us to (7) define this relationship as a relationship of aggressivity, is the one which the formula defined at the point that we make equal to zero the moment - I mean here in the physical sense - of this desire, namely of what I wrote here as $d(o) : 0 > d(0)$, in other words desire qua determined by the first characteristically negotiable object. Here effectively one can say that the subject finds himself confronted with what is expressed in Hegelian phenomenology, by the impossibility of the co-existence of self-consciousnesses, and which is nothing but the impossibility for the subject, at the level of desire, of finding in himself, as subject, his cause.

Here you ought to see already the beginning of the consistency between this function of cause and this phantasy, this phantasy characteristic of a thinking that is in a way forced, for human speculation, about this notion of causa sui in which this thinking takes comfort from the existence somewhere of a being to whom his cause would not be foreign.

Compensation, phantasy, the arbitrary surmounting of this aspect of our condition, that the human being is first of all subjected to having produced the cause of his desire in a danger that he does not know. To this is linked this supreme and magisterial tone with which there reverberates, and ceaselessly reverberates, at the heart of Sacred Scripture, despite its blasphematory aspect, the text which has remained from Ecclesiastes, and what gives it its tone, its accent, if not the fact that "All is vanity", vanity, what we translate in that way, is in Hebrew the following,, pronounced ruach, whose three radical letters I am writing for you and which means wind, or again breath, a mist, if you wish, something which is effaced, which leads us back to an ambiguity, I believe, more legitimate to evoke here, as regards the most abject aspect of this breath, than anything that Jones elaborated in connection with the conception of the Madonna through the ear.

This theme, this thematic of vanity, is indeed what gives its accent, its resonance, its ever present import to the Hegelian definition of this, of the original and fruitful struggle from which there begins the Phenomenology of the spirit, he tells us, of the fight to the death for pure prestige, he tells us, which has indeed the accent of meaning the fight for nothing.

To make the treatment of obsession turn around aggressivity, is, in an obvious and I might say avowed fashion - even if it is not deliberate - to introduce at its principle the subduction of the desire of the subject to the desire of the analyst, in so far as, (8) like every desire, it is articulated elsewhere than in its internal reference to o , this desire is identified to an ideal to which, in a necessary way, the desire of the patient will be bent, in so far as this ideal is the position that the analyst has obtained or believes he has obtained with respect to reality.

Now the o that is involved, marked thus as cause of desire, is not this vanity, nor this tearing apart. If it is indeed in its function what I am articulating, namely this object defined as a remainder, as that which is irreducible to symbolisation at the locus of the Other - which depends on it certainly, for otherwise how would this remainder be constituted - if o is the unique of existence in so far as it puts itself forward, not at all, as has been said, in its facticity - for this facticity is only situated in its reference to a so-called mythical noetic necessity, which itself is supposed to be posited as the primary reference - there is no facticity in this remainder in which there is rooted the desire which will manage, more or less, to culminate in existence.

The more or less extreme severity of its reduction, namely what makes it irreducible, and in which everyone can recognise the exact level to which it has raised itself at the locus of the Other, here is what is defined in this dialogue which is played out on a stage, from which the principle of this desire, after having mounted it, has to fall off it through the test of what it will have left there in a relationship of tragedy, or more often of comedy.

It is played out there, of course, as a role; but it is not the role that counts - and this we all know from experience and from previous certainty - but what remains beyond this role. A remainder that is precarious and delivered up no doubt, for I am always a cedable object, as everyone knows in our day: an object of exchange. And this object is the principle which makes me desire, which makes me the desirer of a lack which is not a lack of the subject, but a failure brought about in the jouissance which is situated at the level of the Other.

This is why every function of the o refers only to this central gap which separates desire from the locus of jouissance at the sexual level, which condemns us from this necessity which means that jouissance is not naturally promised to desire for us, that desire can only go out to meet it, that in order to meet it desire must not only understand, but break through the very phantasy which sustains it and constructs it, the one that we have discovered as this stopping point which is called castration anxiety. But why not castration desire, since at the central lack which disjoins desire and jouissance, there is also (9) suspended a desire whose threat to everyone is only constructed from its recognition in the desire of the Other. At the limit, the other, whoever he may be, appears in the phantasy to be the castrator, the agent of castration.

Undoubtedly here the positions are different and one can say that for the woman the position is more comfortable, the business is already done; and this indeed is what gives her a much more special link with the desire of the Other.

This indeed is also why Kierkegaard can say this singular and, I believe, profoundly correct thing that the woman is more anxiety-ridden than the man. How would this be possible, if precisely at

this central level anxiety was not constructed precisely, and as such, from the relationship to the desire of the Other.

Desire, in so far as it is desire of desire, namely temptation, is what at its heart brings us back to this anxiety in its most original function.

Anxiety, at the level of castration, represents the Other, since encountering a weakening of the apparatus gives us the object here in the form of a lack (carence).

Do I need to recall what in the analytic tradition, confirms here what I am in the process of articulating? Who is the one who gives us the first example of a castration, attracted, assumed, desired as such, if not Oedipus?

Oedipus is not first of all the father. This is what I have meant for a long time in pointing out ironically that Oedipus could not have had an Oedipus complex.

Oedipus is the one who wishes to pass authentically - and mythically also - to the fourth level, which I must indeed tackle along his exemplary path, the one who wishes to violate the prohibition concerning the conjunction of o - here (-J>) - with anxiety, the one who wishes to see what is beyond the most complete satisfaction of his desire. The sin of Oedipus, is the cupido sciendi, he wants to know. And this is paid for by the horror that I described, that what he finally sees are his own eyes, o, thrown on the ground.

Does this mean that this is the structure of the fourth level, and that there is always present somewhere this bloody ritual of blinding? No. It is not necessary - and this is why the human drama is not tragedy, but comedy: they have eyes in order not to see - it is not necessary for them to tear them out. (10) Anxiety is sufficiently rejected, miscognised by the simple capture of the specular image, i(o), for which the best that can be wished is that it is reflected in the eyes of the Other. But there is no need even, because there is the mirror.

And here the articulation according to the table of reference that I described the last time for you: the inhibition, symptom, anxiety of the fourth level, here is more or less how I would describe it:

- At the level of inhibition, it is the desire not to see which, given the arrangement of phenomena, scarcely needs to be sustained. Everything is satisfactory there. Miscognition as structural at the level of the "not to see" is there.

- On the second line and on the third, as dismay, as ego-ideal, namely that which of the Other is, as they say, is the easiest to introject. Of course, it is not at all without reason that this term introjection is introduced here; nevertheless I would ask you not to accept it without reservation. For in truth the ambiguity which remains between this introjection and projection,

sufficiently indicates to us that it is necessary, in order to give its full meaning to the term introjection, to introduce another level at the heart of the central "symptom" of this level as it is specially incarnated at the level of the obsessional that I already designated: it is the phantasy of omnipotence correlative to the fundamental impotence to sustain this desire not to see.

Here what we will put at the level of acting-out, is the function of mourning, in so far as I am going to ask you to recognise in a moment what in the course of last year I taught you to see in it, a fundamental structure in the constitution of desire.

Here at the level of the passage a l'acte, a phantasy of suicide whose character and authenticity are to be put in question essentially within this dialectic.

Here anxiety always in so far as it is masked.

Here at the level of embarrassment what we will legitimately call - for I do not know if enough account is taken of the audacity of what Kierkegaard contributes in speaking about the concept of anxiety; what can that mean, if not the affirmation that: either there is the function of the concept according to Hegel, namely somewhere symbolically a veritable (11) hold on the real, or the only hold that we have - and this is where it is necessary to choose - is the one that anxiety gives us, the only final apprehension as such of all reality. The concept of anxiety as such only arises therefore at the limit of a meditation which nothing indicates to us is not going to encounter its stopping-point very soon.

I	Desire not to see	Impotence	Concept of anxiety
S	Miscognition (desire not to know)	Omnipotence	Suicide
A	Ideal	Mourning	Anxiety

But what matters for us, is to rediscover here the confirmation of truths that we have already tackled from other angles. What does Freud articulate at the end of his speculation about anxiety, if not this: "After all", he says, "I have just told you, put forward, about the relationships between anxiety and the loss of the object, what is it that can distinguish it from mourning?" And this whole codicil, this appendix to his article - you can consult it - only marks the most extreme embarrassment in defining the fashion in which one can understand that these two functions, to which he gives the same reference, have such diverse manifestations.

I would ask you here to dwell with me for a moment on what I think I ought to remind you of, that what our interrogation here

led us to when we were speaking about Hamlet as an eminent dramatic personage, as emergence at the dawn of modern ethics of the relationship of the subject to his desire, what I highlighted that it is at once the absence of mourning - and simply and properly speaking of mourning by his mother - which made there vanish, dissipate, collapse in the most radical way in him the possible elan of a desire in this being who is presented to us moreover well enough, I believe, for one or other person to have recognised him, even identified to the very style of the hero of the Renaissance, Baldassare Castiglione, for example. Do I need to remind you of him: he is the personage about whom the least that can be said is that he does not retreat before very much, and that he does not lack daring! The only thing that he cannot do, is precisely the act that he is made to do, because the desire is lacking, the desire is lacking because the ideal has collapsed. What can be more doubtful in the words of Hamlet than this sort of idolatrous relationship that he outlines of the reverence of his father, of his father for this creature whom we are astonished that this supreme king, the old Hamlet, the dead Hamlet, literally bows down before to pay her homage, ensconced in his loving allegiance? Do we not have here the signs even of (12) something too forced, something too exalted, not to be of the order of an unique love, of a mythical love, of a love akin to this style of what I called courtly love, which, outside its properly cultural and ritual references, through which it is obvious that it is addressed to something other than the woman, is the sign on the contrary of some lack or other, of some alibi or other, before the difficult paths that the access to a true love represents.

The correspondence between the animal evasion of the maternal Gertrude from this whole dialectic, and the overvaluation which is presented to us in Hamlet's memories about the attitude of his father is obvious here; and the result, is that, when this ideal is contradicted, when it collapses - let us notice it - what disappears in Hamlet is the power of desire which will not, as I showed you, be restored until the vision outside of a mourning, a true one, with which he enters into competition, that of Laertes for his sister, for the object loved by Hamlet, and from whom he had found himself suddenly, through lack of desire, separated.

Does this not open the door for us, does it not give us the key which allows us to articulate better than Freud does and along the line of his own interrogation what is meant by mourning. Freud points out to us that the subject of mourning has to perform a task which is, in a way, to consummate a second time the loss provoked by the accident of the destiny of the beloved object.

What does that mean? Does the work of mourning not appear to us, in a light that is at once identical and contrary, as the work which is done to maintain, to sustain all these links in detail. And God knows how much Freud insists, and quite rightly, on the scrupulous and detailed aspect of the remembering of mourning concerning everything that was experienced in terms of a link with the beloved object.

It is this link that must be restored with the fundamental object, the masked object, the object o, the veritable object of the relationship, for which subsequently a substitute may be provided which will not have, when all is said and done, any more importance than the one who first occupied the place.

As one of you, a humorist, said to me during one of our Journees Provinciales, there is a story well designed to show us in the cinema that any "irreplaceable German" whatsoever - he was alluding to the adventure that is described for us in the film Hiroshima mon amour - this irreplaceable German can find an (13) immediate and perfectly valid substitute in the first Japanese encountered at the street corner.

The problem of mourning is that of the persistence of what? The bonds through which desire is suspended, not at all on the object o at the fourth level, but on i(o) through which every love, in so far as this term implies the idealised dimension that I have spoken of, is structured narcissistically.

And this is what makes the difference between what happens in melancholy and mania. If we do not distinguish the object o from i(o), we cannot conceive of what Freud, in the same note, recalls and powerfully articulates, just as in the well-known article on "Mourning and melancholia", about the radical difference there is between melancholia and mourning.

Do I need to refer to my notes and to remind you of this pass.-: where, after having become engaged in the notion of the return, of the reversion of the supposedly "objectal" libido onto the subject's own ego, he admits: in melancholia, it is obvious that this process - he is the one who says it - does not reach a conclusion, the object overcomes its direction, it is the object that triumphs. And since what is involved as a return of the libido in mourning is something different, it is also for that reason that the whole process, that the whole dialectic is constructed differently, namely that this object o, Freud tells us that it is necessary then, - and why in this case? I am leaving it to one side here - it is necessary then that the subject explain himself, but that, since this object o is usually masked behind the i(o) of narcissism, that the i(o) of narcissism is there so that, at the fourth level, the o should be masked, miscognised in its essence, this is what makes it necessary for the melancholic to pass, as I might say, through his own image, and to attack it first in order to reach in this object o, which transcends it, the thing whose control escapes him, the thing whose collapse will lead him into precipitation, suicide, with this automatism, this mechanism, this necessary and fundamentally alienated character with which as you know the suicides of melancholies are carried out, and not in an indifferent context: and if this happens so often by a window, if not through a window, this is not by chance, it is the recourse to a structure which is none other than the one that I emphasise as being that of the phantasy.

We can only grasp this relationship to o, through which there is

distinguished everything that belongs to the "mania-melancholy" cycle, everything that belongs to the "ideal", the reference "mourning or desire", in the accentuation of the difference of (14) the function of o as compared to i(o), as compared to something which makes this reference to o fundamental, radical, more rooting for the subject than any other relationship whatsoever, but also as fundamentally miscognised, alienated, in the narcissistic relationship.

Let us say right away, in passing, that in mania, it is the non-function of o, and not simply its miscognition that is at stake. It is the something through which the subject is no longer ballasted by any o, which delivers him, sometimes without any possibility of freedom, to the infinite and purely playful metonymy of the signifying chain.

This - no doubt I have here avoided many things - this is going to allow us to conclude, at the level where this year I intend to leave you. If desire, as such, and in its most alienated, most fundamentally phantastical character, is what characterises the fourth level, you can remark that if I initiated the structure of the fifth, that if I indicated that at this level the o is resharpened, this time openly alienated, as support of the desire of the Other, who this time is named, it is also to tell you why I will stop this year at this term.

The whole dialectic in effect of what is happening at the level of this fifth level implies a more detailed articulation than has ever been carried out with what I designated earlier as introjection, which implies as such - I was content to only indicate it - the auditory dimension, which implies also the paternal function.

If, next year, things turn out in a way that allows me to continue my Seminar along the path I anticipate, it is around, not simply the name, but the names of the father that I will make a rendezvous with you.

It is not for nothing that in the Freudian myth the father intervenes in the most obviously mythical way as being the one whose desire submerges, crushes, is imposed on, all the others. Is there not here an obvious contradiction with this fact obviously given by experience that through his voice it is precisely something quite different that takes place, namely the normalisation of desire along the paths of the law?

But is that everything? Necessity itself, alongside what is here traced, represented, rendered tangible by experience, and even down to the facts frequently weighed by us about the absence (carance) of the function of the father, does the necessity of maintaining the myth not draw our attention to something else, to the necessity for the articulation, for the support, for the maintaining of a function which is the following, which is that the father, in the manifestation of his desire, knows for his part to what o this desire is referred. The father is not causa sui, in accordance with the religious myth, but a subject who has

gone far enough in the realisation of his desire to integrate it to its cause whatever it may be, to what is irreducible in this function of o qua - I ask you to grasp - what allows us to articulate, at the origin of our research itself and without avoiding it in any way, that there is no human subject who does not have to posit himself as a finite object to which are appended finite desires, which only take on the appearance of becoming infinite in so far as by escaping from one another always further from their centre, they carry the subject always away further from any authentic realisation.

Now this relationship, this miscognition of o, is something which leaves a door open. We have always known it, there was no need even for analysis to show it to us, since I believe I was able to show it to you in a dialogue of Plato, The Symposium. The object o, in so far as at the term - a term no doubt never achieved - it is our most radical existence, is the only path along which desire can deliver us that in which we will have to recognise ourselves, this object o is to be situated as such in the field of the Other, and not only is it to be situated there, but it is situated there by each and every one. And this is what is called the possibility of transference.

The interpretation that we give is always brought to bear on the greater or lesser dependence of desires with respect to one another. But it is not a confrontation of anxiety. There is only an overcoming of anxiety when the Other has named himself. There is no love except that for a name, as everyone knows from experience. And the moment that the name is pronounced of him or of her to whom our love is addressed, we know very well that it is a threshold which is of the greatest importance.

This is only a trace, a trace of this something which goes from the existence of o to its passage into history. What makes of a psychoanalysis a unique adventure is this search for the agalma in the field of the Other. I have often questioned you about what the desire of the analyst should be in order that, there where we are trying to push things beyond the limit of anxiety, work is possible.

Undoubtedly it is fitting that the analyst should be one who has been able, however little it may be, from some angle, from some tack, to make his desire sufficiently enter into this irreducible o to offer to the question of the concept of anxiety a real guarantee.